

# Segway eMoped User Manual

———— B series ————

The manufacturer reserves the right to make changes to the vehicle, release firmware updates, and update this manual at any time. Visit [www.segway.com](http://www.segway.com) or check the Segway-Ninebot app to download the latest user materials. In order to activate your Segway eMoped and obtain the latest updates and safety instructions, you must install the Segway-Ninebot app.



## Contents

1. Safety Instructions .....	01
2. Product Overview .....	06
3. Parts and Functions .....	08
4. Activation .....	12
5. How to Charge .....	13
6. How to Install the Battery .....	14
7. Learn to Ride .....	15
8. Maintenance .....	17
9. Specifications .....	20
10. Certifications .....	22
11. Trademarks and Legal Statement .....	22
Appendix: Installation of the Rear-view Mirrors .....	26

Original instructions

## Welcome

Thank you for choosing Segway eMoped B110S (referred to as "the vehicle" in this manual).

Combining advanced wireless positioning technology and smart app control, the vehicle promises a brand-new riding experience.



Segway-Ninebot App

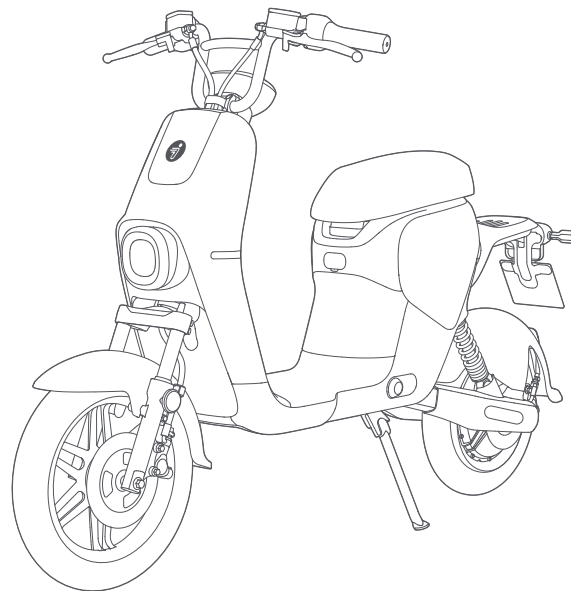

Please read the user manual carefully to fully understand the vehicle's usage and maintenance methods. Please note that the pictures shown are for illustration purpose only. The pictures do not refer to a particular model of product. Actual product may vary due to different models. No legal claims can be made on the basis of data in this manual.

## 1. Safety Instructions

Remember that whenever you ride the vehicle, you risk injury from loss of control, collisions, and falls. To reduce the risk, you must read and follow all “CAUTION” and “ WARNING” indications. Please understand that you can reduce the risk by following the instructions and warnings in this manual, but you cannot eliminate all the risks. Please use common sense when riding.

- It is the rider’s responsibility to follow local laws and regulations and abide by relevant laws and traffic regulations. ONLY ride on roads as permitted by law.
- In order to master riding skills, the rider needs to practice. Use with caution since skill is required to avoid falls or collisions causing injury to the user or third parties. To avoid injuries, DO NOT allow people who are aware of proper operations to ride the vehicle. Neither Ninebot (Ninebot (Beijing) Tech Co., Ltd. and its subsidiaries and affiliates) nor Segway (Segway Inc. and its subsidiaries and affiliates) is responsible for any injuries, damages or legal disputes caused by a rider’s inexperience or failure to follow the instructions in this manual.
- For your safety, please DO NOT modify the vehicle or change parts by yourself. Use only Segway approved parts and accessories. Modifications to the vehicle could interfere with its operations, and may result in serious injury and/or damage, or void the Limited Warranty.
- If the vehicle makes an abnormal sound or signals an alarm, stop riding immediately.
- DO NOT allow anyone to ride the vehicle on his/her own unless he/she has carefully read this manual. Assist new riders until they are comfortable with the basic operation of the vehicle.
- DO NOT park the vehicle in no-parking zones, such as an emergency exit, building lobbies or fire escapes.
- Do not charge or park the vehicle inside of residential buildings. Keep away from combustible materials when charging, and disconnect from the power supply once it’s fully charged.

### Riding Surfaces and Environment:

- Slow down when riding in complicated road conditions. Riding at high speeds to cross over obstacles, on uneven ground, slippery surfaces, loose ground, steep slope or at sharp turns, can lead to falls, collisions or even death.
- DO NOT ride in bad weather such as heavy rain or storm. When riding in rainy or snowy weather, the traction is reduced and the braking distance is increased. For your safety, please drive at slower speeds and brake earlier to reduce the risks for loss of control and falls.

### Who Should Not Ride:

People in the following groups should not ride the vehicle:

- I. Anyone under the influence of alcohol, drugs, or intoxicants.

- II. Anyone who suffers from diseases that put them at risk if they engage in strenuous physical activity.
- III. Anyone whose age and weight is outside the stated limits (See *Specifications*).
- IV. People who are extremely tired.

### Preparations before Riding:

- The rated loading capacity is 1 person. Overloading will cause riding difficulty and risk of injury. Please do not overload or use the vehicle to carry heavy object(s).
- Make sure there are no loose fasteners and/or damaged parts.
- Check the status of the power supply circuit, lighting, dashboard display, etc. and make sure they work normally.
- The front and rear brakes should function properly and the brake cables should be in good condition.
- Make sure the handlebar is stable, and that the front and rear wheels are not shaky or loose.
- Make sure the reflectors are not damaged or dirty.
- The rider must wear a helmet and other protective gear.
- When the battery is low (the dashboard shows less than two bars), please use the original charger to charge immediately.
- Ensure normal tire pressure, with front tire 29 psi (200 kPa) and rear tire 32 psi (220 kPa). Make sure the tire tread is intact.

### WARNING

Always wear a helmet when riding. Use an approved helmet that fits properly with the chin strap in place, and provides protection for the back of your head.

### Instructions on Riding and Usage:

- DO NOT accelerate or brake abruptly when riding.
- Please hold the handlebar with both hands to avoid serious injuries due to loss of balance or falling.
- Stay alert and ride defensively. Always keep a safe distance from other vehicles. Slow down when entering a new environment.
- DO NOT use a cell phone, camera, headphones, earbuds or perform any other activities while riding.
- Slow down when approaching intersections, motorways, corners, doors, etc. Yield the right of way for pedestrians, bicycles and motor vehicles.
- If any abnormality occurs, stop riding immediately and contact the after-sales service in time. DO NOT ride before the cause of the abnormality is diagnosed and repaired.
- Always park the vehicle on a flat surface. Otherwise, the vehicle may slip and fall over causing harm.
- ONLY use the original charger. Allow the vehicle to stay still for a while before charging. Do not attempt to charge your vehicle if it, the charger, or the power outlet is wet.

## Warnings and Precautions

Potential safety hazards involved.  
Avoid all dangerous driving activities!

 DO NOT drive under the influence!

 Slow

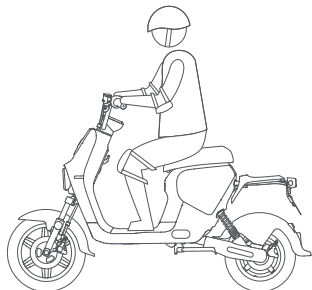

 When riding on the road, always obey traffic rules, local laws and regulations.  
When riding off-road, slow down, watch for changing road conditions and avoid possible hazards.

 Slow

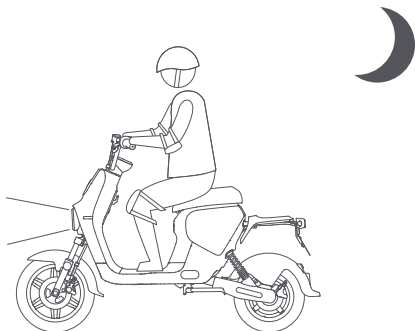

 Make sure the headlight is on when driving at night.

 Overload

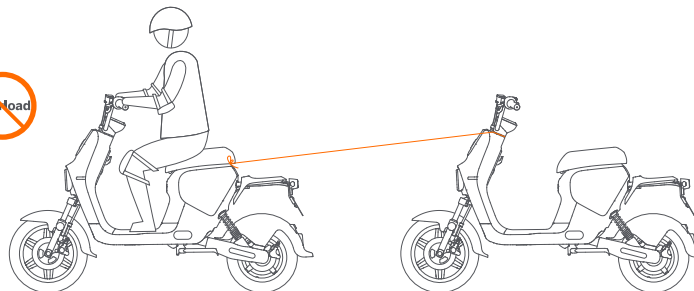

 NEVER tow other vehicle(s).

 Slow

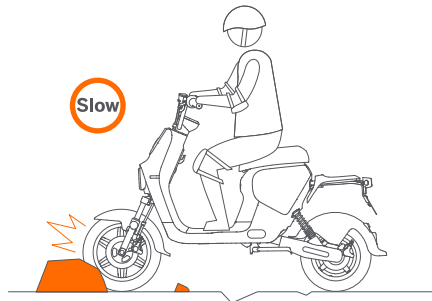

 Please drive slowly and carefully in complicated road conditions.

 Overload

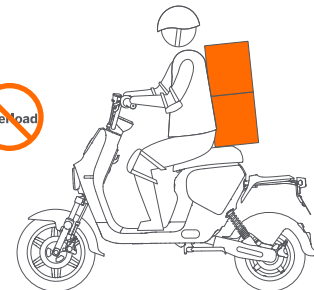

 DO NOT carry heavy objects and/or passengers.



⚠ DO NOT ride in bad weather such as heavy rain and snow.

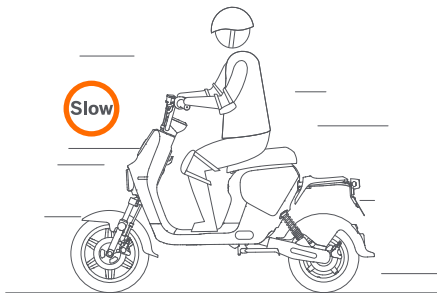

⚠ Hold the handlebar with both hands. No speeding.

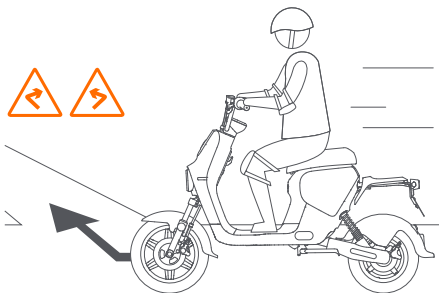

⚠ Slow down before making a turn. Use caution when riding and DO NOT make sharp or sudden turns.

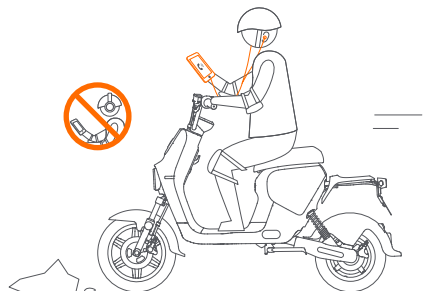

⚠ DO NOT use mobile phones, cameras, headphones, earplugs, etc. when driving.

## 2. Product Overview

Segway eMoped B110S

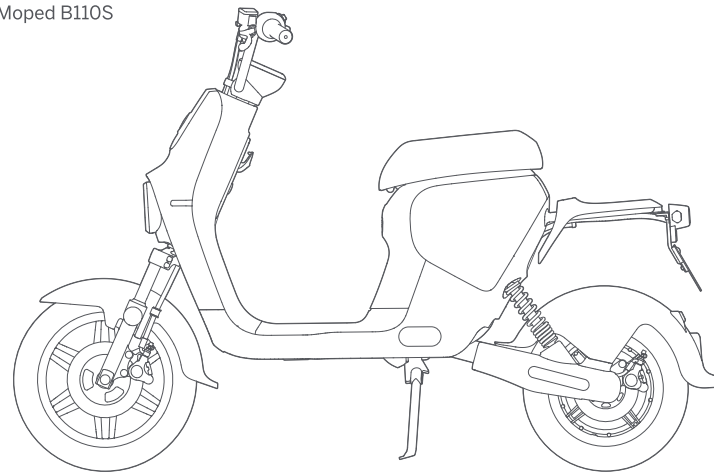

### Accessories



Use manual × 1



Service manual × 1

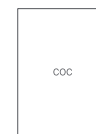

COC × 1

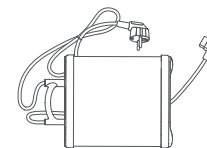

Battery charger × 1

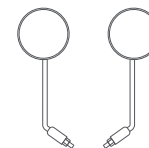

Rear-view mirrors

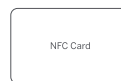

NFC Card × 2



Spare key × 2

## Spare Key

Before riding for the first time, use the key to open the seat bucket and connect the battery power plug. Enable the Handlebar Lock switch by lifting it and then rotating the knob counter-clockwise.

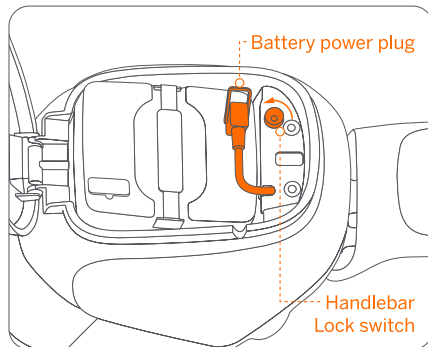
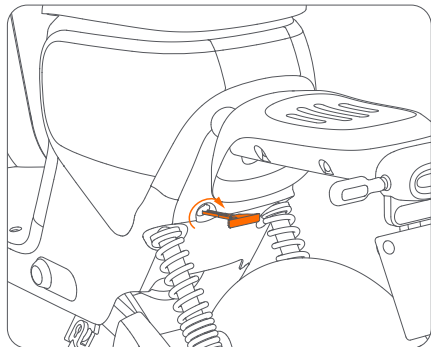

The key can open the seat bucket. For the convenience of use, please keep one key in the slot on the battery.

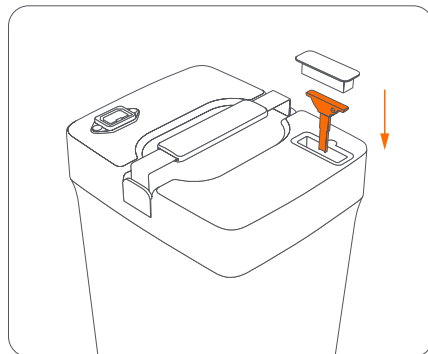
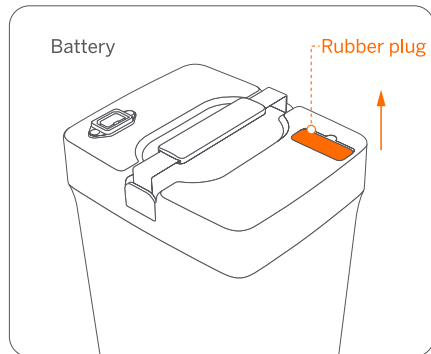

## 3. Parts and Functions

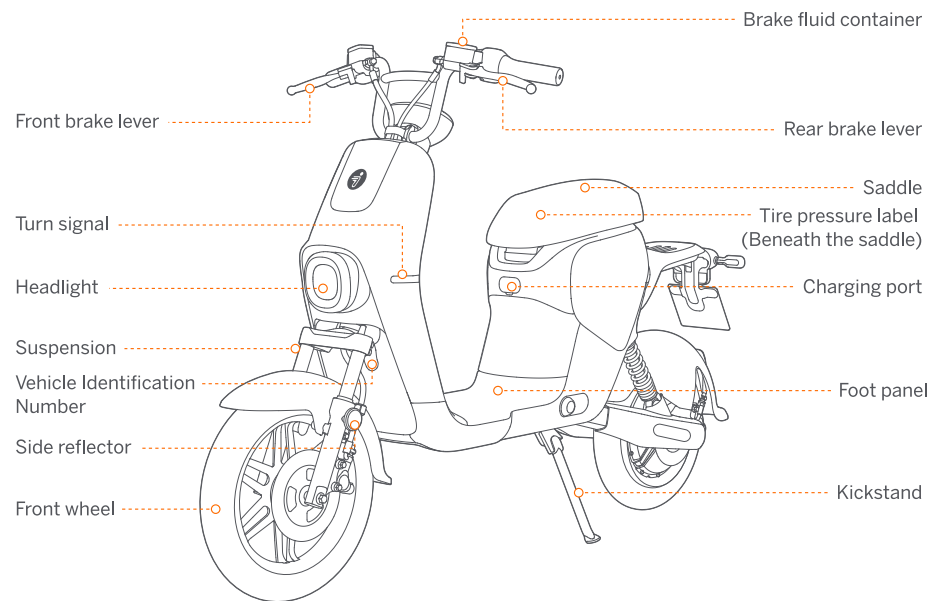

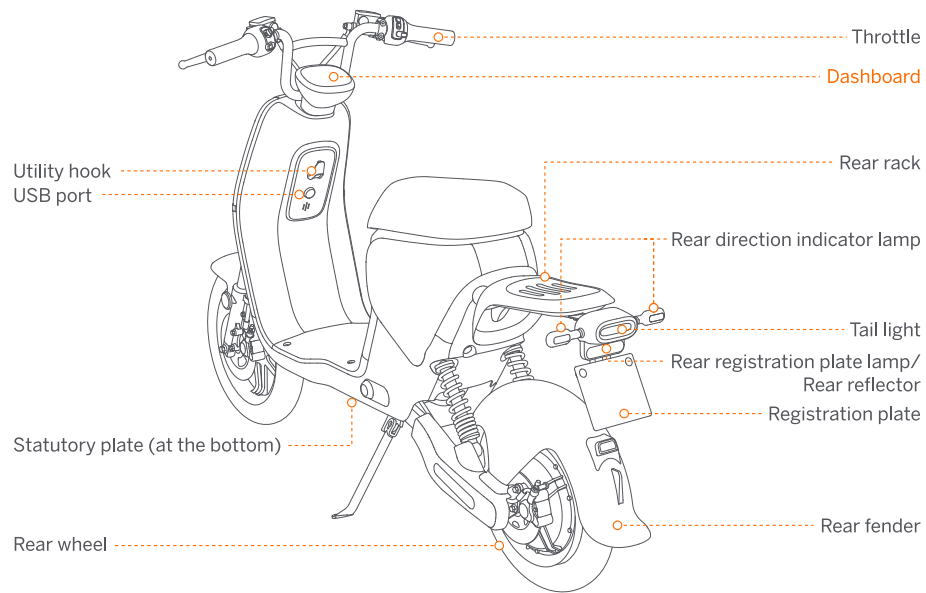

### Dashboard

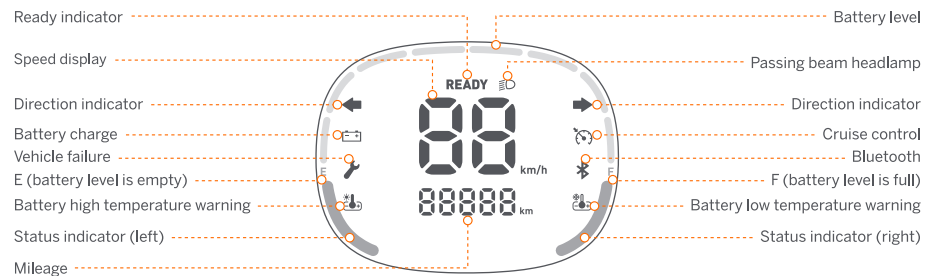

### Riding Status Ring Colors and Meanings



Green: Ready to go



Blue: ① Power assist mode  
② Cruise mode

\*You can enable and disable the Power assist mode via the Segway-Ninebot app.



Orange: Standby, unable to ride



Red: Error

Symbol	Symbol Name	Description	Notes
<b>READY</b>	READY indicator	When READY is on, is good to go.	When the kickstand is in the up position and a person sits on the seat, press the Auto Key, and <b>READY</b> is on.
	Passing beam headlamp	Passing beam symbol is on when the main headlamp is switched on.	The light is on by default when is turned on.
	Speed display	1. Indicates the current speed. 2. Displays the error code when there is a malfunction.	<b>km/h</b> : Metric unit
	Mileage	Indicates the total distance traveled.	<b>km</b> : Metric unit
	Direction indicator (Left/Right)	1. Flashes when the left/right turn button is pressed. 2. When both direction indicators (left and right) light up simultaneously with the warning indicator, the vehicle is in a warning state.	1. When toggled ① (on left combination switch) to the left/right, the left/right turn signal is on. Press ① to turn off the turn signal. 2. When  (on right combination switch) is pressed, the left/right turn signals and this indicator will flash to alert pedestrians and other vehicles. Press  again to cancel the warning.
	Battery charge	The battery power is low and needs charging when it lights up.	When the battery is low, this indicator lights up and the battery level bar on the dashboard flashes.
	Cruise control	The vehicle is in cruise control when it lights up.	While riding, press  (on the right combination switch) to keep riding at the current vehicle speed; Turn the throttle or brake lever to exit cruise control.
	Vehicle failure	When the icon flashes, has a malfunction.	
	Bluetooth	The vehicle is connected to a phone when it lights up.	
	Battery high temperature warning	The indicator lights up when the battery temperature is higher than 40 °C.	
	Battery low temperature warning	The indicator lights up when the battery temperature is lower than 5 °C.	
	Battery level	Bars of remaining battery.	

## Controller switch

### Left combination switch

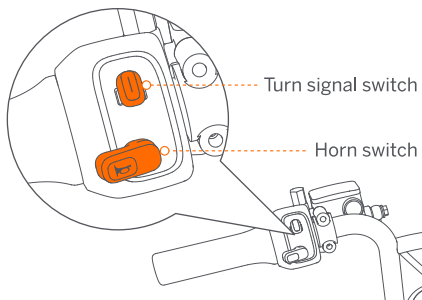

### Right combination switch

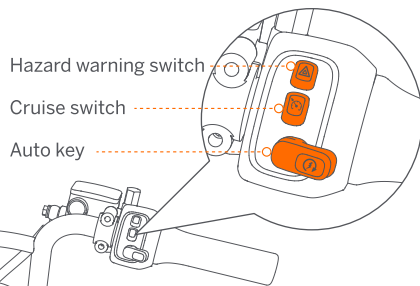

Symbol	Symbol Name	Description
	Turn signal switch	When toggled to the left, the left turn signal turns on. Press to turn off the left turn signal. When toggled to the right, the right turn signal is on. Press to turn off the right turn signal.
	Horn switch	When pressed, the horn is sounded to alert pedestrians or other vehicles.
	Hazard warning switch	When the button is pressed, both the left and right turn signals will flash to alert pedestrians and other vehicles.
	Cruise switch	When pressed, the vehicle will cruise at the current speed. The cruise control can be canceled by pressing the button again, turning the throttle or, by braking.
	Auto key	When the vehicle is on, double-press to open the seat bucket or press and hold to switch off the vehicle. If AirLock is enabled in the app, hold this button while the paired phone is within range to turn on the vehicle. When the kickstand is folded up and the rider is on the seat, press this key and READY symbol comes on.

## 4. Activation



Segway-Ninebot app

When not activated, the vehicle will be limited to 6.2mph (10 km/h) and the AirLock would not work.

To enjoy the full functionality of the vehicle, please scan the QR code to download the app and finish the New Rider Tutorial. Alternatively, go to the Google Play Store (Android) or the Apple App Store (iOS) and search for "Segway" or "Ninebot" to download and install the app. To ensure Bluetooth communication, keep your phone close to the vehicle during the activation process.

- 1 Install the app, register and log in.
- 2 A flashing Bluetooth indicator means the vehicle is waiting for a connection.

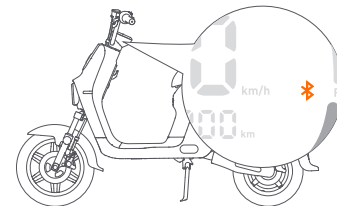
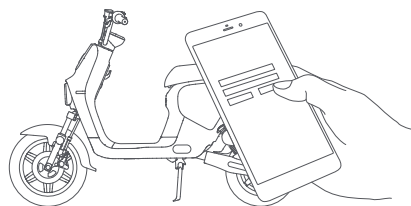

- 3 Click 'Search vehicle' to connect to the vehicle. The Bluetooth signal will stop flashing when the connection is successful.

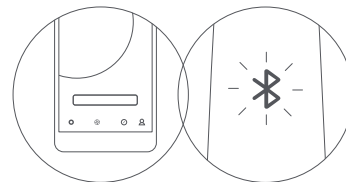

- 4 Follow the instructions to activate your vehicle and complete the New Rider Tutorial. The speed limit would now be lifted within the local legal bracket and the AirLock could be activated via the app.



## 5. How to Charge

The battery level may be low or empty during transportation and storage. You can charge using any one of the methods mentioned below. Remember to unplug from the power supply once fully charged.

### 1 Charge the Vehicle

Connect the battery power plug, then close the seat bucket. Connect the charger output to the vehicle charging port, and then connect to the power outlet.

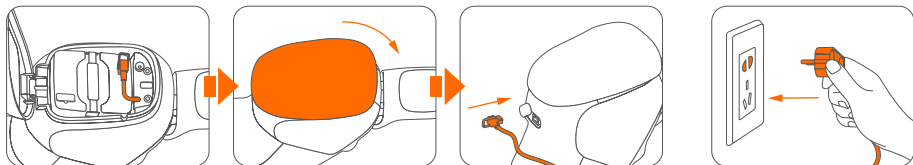

### 2 Internal Charging

Connect the charger output directly to the battery charging port, plug into the power outlet, and then close the seat bucket.

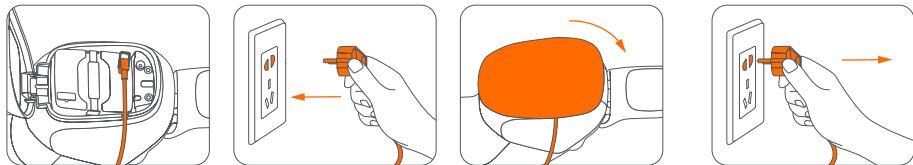

### 3 Charge the Battery

Open the seat bucket and take out the battery. Connect the charger output to the battery charging port, and then connect to the power outlet.

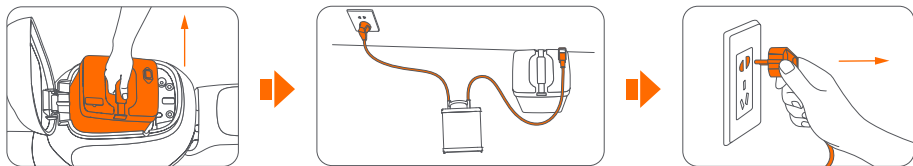

\*The charger indicator is red when charging and turns to solid green when fully charged. If the temperature of the vehicle body exceeds 104°F (40°C), it cannot be charged normally. Please wait for the temperature to drop.

### ⚠ WARNING

- ONLY use the original charger. Other types may explode and catch fire.
- DO NOT charge if the battery is wet or damaged.
- DO NOT connect the charger when the charging port or charging cable is wet.

## 6. How to Install the Battery

After charging the battery, please put it into the vehicle by following steps:

### 1 Open the seat bucket by any of the following methods.

- Use the key.
- Squeeze hold one brake lever and tap the NFC card on the dashboard.

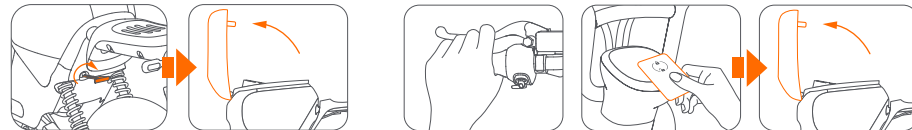

- If the battery is in, squeeze and hold any brake lever and hold the Auto key. If the battery is not in, press and hold the Auto key, wait until the E, F, as well as the phone connection signal light up, and then squeeze one brake lever while holding the Auto key.

\*Please enable the AirLock in the app in advance. Make sure the ECU battery is not empty. You can check the battery level in the app.

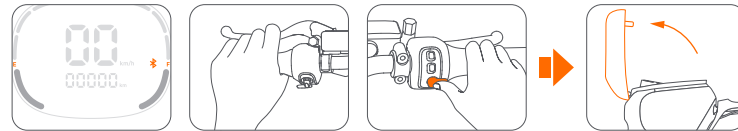

### 2 Put the battery in the vehicle, connect the battery power plug and close the saddle.

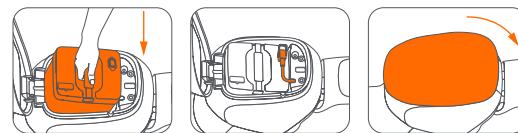

## 7. Learn to Ride

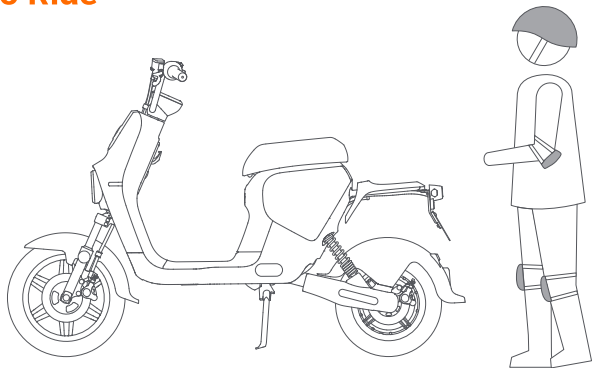

### WARNING

Always wear a helmet and other protective gear to minimize any possible injury in the learning process. Always abide by local laws and traffic rules.

### Power on

The vehicle can be powered on in one of the following ways:

- Tap the NFC card on the dashboard. You will hear a beep when the vehicle is powered on successfully.
- Enable the AirLock in the App. The vehicle will power on when you sit on the saddle, or press and hold the Auto key.

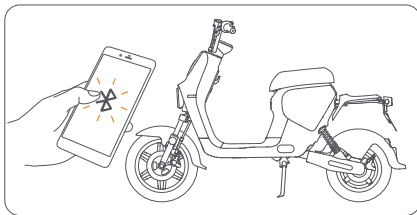
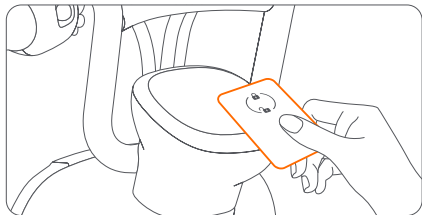

### Riding

Retract the kickstand, sit down on the saddle and with both feet on the ground. Gently turn the throttle inward to start your trip.

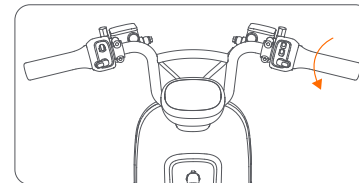
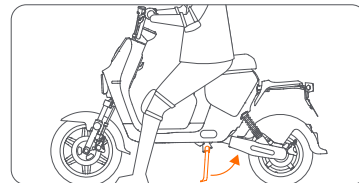

### NOTE:

Before a rider is seated on the saddle, the status light is orange and the throttle is inactive. If the rider leaves the seat during riding, an alarm will sound and disabling the throttle.

### Locking

Release the throttle and pull both brake levers. After the vehicle has come to a stop, kick the kickstand in the down position to support the vehicle upright.

You can lock your vehicle in the following ways:

- Auto lock
  - Enable the 'Auto lock' feature in the app. When you walk away with the phone, the vehicle will lock automatically.
- Press and hold the Auto key.
- Tap the NFC card.

### NOTE:

- After locking, please turn the handlebar to its left end to ensure that the Handlebar Lock is activated.
- The manual switch of the Handlebar Lock is located inside the seat bucket. You can operate the switch to enable/disable the lock.

### Anti-theft Alarm

When the vehicle is locked, if there are any abnormal movements detected, the status light will flash red and green and a continuous alarm will start to sound.

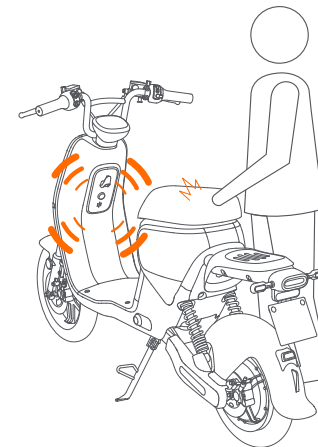

## 8. Maintenance

### Cleaning

Clean with water, neutral detergent and a soft cloth.

### CAUTION

DO NOT clean with alcohol, gasoline, acetone, or other corrosive/volatile solvents. These substances may damage the appearance and internal structure of your vehicle. DO NOT wash with a power washer or hose. DO NOT rub with sandpaper or metal brush.

### ⚠ WARNING

Before cleaning, make sure the vehicle is powered off.

### Storage

Store in a dry and cool place indoors and avoid sunlight and rain, so as not to rust parts and shorten the service life. Disconnect the battery power plug for long-time storage to prevent over-discharge.

### Motor

1. When riding in wet conditions, the water level should not exceed the central axis of the rear wheel.
2. Clean the vehicle after each ride to prevent particles from entering the motor and affecting its normal use.  
Do not spray water directly when cleaning.
3. Check if there is abnormal noise when the motor is running.

### Battery

1. DO NOT drain the battery. It is recommended to keep the battery level above 15%. Charge after each ride to prolong the service life of the battery.
2. It is strictly prohibited to disassemble the battery. There is a danger of electric shock, short circuit, fire, explosion, etc.
3. When the battery indicator bars are all lit up or the charger indicator turns green, it means the battery is fully charged.
4. The storage temperature for the battery is 32–95°F (0–35°C).

**5. If you are not going to use the vehicle for a long time, take out the battery after it is fully charged, place in a dry and well-ventilated place, and charge it every two months.**

6. DO NOT store the battery in a place where there is a risk of falling. Falling may cause battery damage, short circuit, fire and explosion.

### ⚠ WARNING

DO NOT disassemble the battery. For information about the recycling and disposal of the battery and electrical waste, please contact your household waste disposal service, your local or regional waste management office, or your point-of-sale.

### ⚠ WARNING

- Risk of Fire - No user serviceable parts

### Charger

#### ● Before charging:

1. The charger should ONLY be used to charge the original vehicle/battery. It is strictly prohibited to charge non-rechargeable batteries.
2. To prevent the electronic components inside the charger from loosening, DO NOT carry the charger in the vehicle.
3. The power supply voltage should be 100–240V AC.
4. DO NOT use when there are broken cables or loose connectors.

#### ● During charging:

1. Place the vehicle in a safe place away from rain and sun exposure.
2. Connect to the battery or vehicle charging port first, and then plug into the power supply.
3. When there is an abnormal smell, sound or light display, stop charging immediately and contact after-sales service.

#### ● After charging:

1. When the battery is full, disconnect from the power outlet first and then unplug the charger plug.
2. After the charger cools down, place it in a safe place inaccessible to children.

### WARNING

1. Ensure good ventilation during charging. Stay away from fire or explosive materials!
2. High voltage in the charger! DO NOT disassemble or replace parts of the charger.
3. DO NOT connect the charger to the power outlet for a long time. Unplug from the power outlet when not charging. DO NOT use the charger to charge multiple vehicles.
4. The charger should be handled with care. Keep away from outdoor elements such as rain and heat.
5. For more information about the repair and maintenance, please visit <http://nl-nl.segway.com/after-sales>.

### NOTICE: INSURANCE

**YOUR INSURANCE POLICIES MAY NOT PROVIDE COVERAGE FOR ACCIDENTS INVOLVING THE USE OF THIS PRODUCT. TO DETERMINE IF COVERAGE IS PROVIDED, PLEASE CONTACT YOUR INSURANCE COMPANY OR AGENT.**

## 9. Specifications

	Items	B110S	
Vehicle parameters	Vehicle dimensions: length × width × height	66.3 × 27.2 × 43.1 in (1685 × 691 × 1095 mm)	
	Net weight (battery included)	123.5 lbs (56 kg)	
	Max. payload	Approx. 220 lbs (100 kg)	
	Wheelbase	46.7 in (1187 mm)	
	Ground clearance	9.84 in (250 mm)	
	Max. speed	25 km/h	45 km/h
	Electric range (WMTC Stage 3)*	64 km	56 km
	Typical range*	90 km	72 km
	Electric energy consumption	23 Wh/km	26 Wh/km
	Max. slope	Approx. 15°	
	Operating temperature	0–133°F (-18–45°C)	
	Storage temperature	-4–122°F (-20–50°C); 50–86°F (10–30°C) recommended	
	Charging temperature	36–104°F (2–40°C); 50–95°F (10–35°C) recommended	
IP ratings	IPX5		
Battery pack	Battery type	Lithium-ion battery	
	Nominal voltage	48 V	
	Rated capacity	30 Ah	
	Rated energy	1440 Wh	
	Charging time	About 4 hours	
Motor	Motor type	Permanent magnet motor	
	Rated voltage	48 V	
Charger	Input voltage	100–240 V AC	
	Output voltage	52.5 V DC	
	Output current	8 A	
Others	Tyre	Tubeless tyre Front: 12 × MT1.50 Rear: 10 × MT1.85	
	Shock absorption	Centered twin-tube dampers	
	Front brake	Hydraulic disc brake 180mm-3.5mm	
	Rear brake	Hydraulic Disc Brake 155mm-3.5mm	
	Handle grip material	PVC	

\*WMTC criteria: 75kg load ± 5kg, 1.75m ± 0.05m max wind speed of 3m/s with a minimum air temperature of 5°C and a maximum of 35°C.

\*Typical range: The accumulated range of the vehicle (25 km/h or 45 km/h version) tested at their respective maximum speed with 165 lbs (75 kg), 77 °F (25 °C), wind speed < 3m/s on a paved road until no more power remains.

\*Some of the factors that affect range include: rider weight, number of starts and stops, ambient temperature, etc.

e.g. (B110S) maximum achievable range of about 105 km at a constant speed of 20 km/h with 75 ± 5 kg load in about 25 °C temperature.

## Error Codes, Failures and Solutions

Errors and failures	Possible causes	Solutions
Error code 10	ECU (Electronic Control Unit) communication error.	Please check the ECU, dashboard and the connecting cables.
Error code 11	Motor controller undervoltage protection.	Please charge before use.
Error code 12	Motor Hall failure.	Please check the motor, motor controller and the connected cables.
Error code 13	MOS tube malfunction.	Please check the motor, motor controller and the connected cables.
Error code 14	Throttle malfunction.	Please check the throttle handle, motor controller and the connected cables.
Error code 15	The brake switch is abnormal.	Please check the brake lever, motor controller and the connected cables.
Error code 16	An error occurred when saving the configuration.	Please contact after-sales service.
Error code 19	Lithium-ion battery 1 temperature sensor error.	Please check the battery.
Error code 20	Lithium-ion battery 1 communication error.	Please check the dashboard, battery and the connected cables.
Error code 21	Lithium-ion battery 1 has the default serial number.	Please confirm whether it is a genuine battery.
Error code 22	Lithium-ion battery 1 password error.	Please confirm whether it is a genuine battery.
Error code 31	The vehicle has the default serial number.	Please confirm whether it is a genuine product.
Error code 32	Vehicle password error.	Please confirm whether it is a genuine product.
Error code 33	Program error. The dashboard program upgrade has failed.	Please contact after-sales service.
Error code 34	Abnormal vehicle temperature detection.	Please check the dashboard temperature sensor.
Error code 35	Dashboard and ECU communication error.	Please check the ECU, dashboard and the connected cables.
Error code 36	Weak wireless signal in central controller.	Please check whether the vehicle is parked in an open space.
Error code 37	Low battery in the central controller.	Please charge the battery for more than 5 hours.
Error code 38	Electric lock malfunction.	Please check whether the cables are short-circuited or broken.
Error code 39	NFC antenna calibration failed.	Please check if there is metal near the antenna, power supply system abnormality, or if the dashboard needs to be replaced.
Error code 40	AHRS (attitude and heading reference system) error.	Please contact after-sales service.
Error code 41	The handlebar lock is not in place.	Please restart the vehicle and move the handlebar so that the lock pin is retracted.
Error code 42	ECU certificate error.	Please check the ECU.
Error code 43	A collision or severe vibration of the vehicle is detected.	If there is no accident, please check the dashboard.
Error code 44	The internal key of the dashboard is lost.	Please confirm whether it is a genuine vehicle.
Error code 45	The vehicle is in "Lost Vehicle or Battery" mode.	Please contact after-sales service.

## 10. Certifications

This product is certified to EU No 168/2013.

The battery complies with UN/DOT 38.3.

### The Radio Equipment Directive



### Segway-Ninebot EMEA

EU Contact Address for regulatory topics only: Dynamostraat 7, 1014 BN Amsterdam, The Netherlands

Hereby, Nine Tech Co., Ltd. declares that the wireless equipment listed in this section are in compliance with the essential requirements and other relevant provisions of the RED Directive 2014/53/EU.

Bluetooth	Frequency Band(s)	2.4000–2.4835GHz
	Max. RF Power	10 mW

## 11. Trademark and Legal Statement

Segway and the Rider Design are the registered trademarks of Segway Inc., Ninebot, Ninebot AirLock and RideyGo are the registered trademark of Ninebot (Tianjin) Tech Co., Ltd; Bluetooth is the registered trademark of BLUETOOTH SIG, INC.; Android, Google Play are trademarks of Google Inc., App Store is a service mark of Apple Inc., The respective owners reserve the rights of their trademarks referred to in this manual.

We have attempted to include descriptions and instructions for all the functions of the Segway eMoped B110s at the time of printing. However, due to constant improvement of product features and changes of design, your eMoped may differ slightly from the one shown in this document. Please visit the Apple App Store (iOS) or Google Play Store (Android) to download and install the App. and visit [www.segway.com](http://www.segway.com) to download the latest user materials.

Please note that there are multiple Segway and Ninebot models with different functions, and some of the functions mentioned herein may not be applicable to your unit. The manufacturer reserves the right to change the design and functionality of the Segway eMoped B110s product and documentation without prior notice.

© 2021 Ninebot (Beijing) Tech Co., Ltd. All rights reserved.

**IMPORTANT: The user shall agree to read the entire user manual and fully understand its content (especially the parts related to warnings and caution statements) and adhere to the instructions herein before riding this product.** Be aware, this product is an electronic bike that is very different from a traditional man powered bicycle.

1. This product can be dangerous to a user, other persons and property in proximity thereto. The user shall assume all the risks and loss in connection with the vehicle (especially for those related to and/or arising out of violation of the instructions about warnings and caution statements). Such risks include but not limited to loss of control, failure of the vehicle and/or collusion) The consequences for such incident can be severe, including but not limited to injuries, bodily injuries, death and/or damages to property. **SEGWAY and its affiliates shall not be liable for any claim, liability and loss related to such consequences, if it is due to the user's assumption of risk.**
2. The vehicle is a means for transportation and the user may not have necessary and sufficient experience and skills to ride it, especially in complex environments and/or undesirable road and/or traffic conditions. Such risk may increase if the user has physical and/or mental impairment or disability, or a user is under the influence of alcohol, drugs or similar substance. Such risk may also increase if the user is not sufficiently familiar with the functions, features and performance of the vehicle. Thus, the user, especially new users, shall learn and practice how to ride this product properly and safely. Experience accumulated by practice would normally enable a user to better ride and operate the vehicle by time.
3. The parts and components of the vehicle are subject to fatigue, wear and tear ("Wear and Tear"). Many factors, such as environment, aging road conditions and/or riding behaviors may affect the rate of Wear and Tear. Wear and Tear may cause unanticipated and/or sudden failure of the vehicle, which may cause, inter alia, severe bodily injury or even death. So, the user shall regularly and periodically, as the circumstance requires, inspect and maintain the vehicle. The user shall also conduct reasonable examination and inspection of the vehicle every time before riding it. For instance, every time before riding the vehicle, the user shall check and examine tire performance, battery level, brake (including brake cable and that the brake shall have proper tension), vehicle installation status and all functional parts. If abnormality, discoloration or change of color of material (especially in an area that receives high stress when the vehicle is in motion or junction), scratch, crack, loose fasteners, and/or missing

parts (such as screw, bolts and/or nut) which strongly indicates that it is not safe to ride the vehicle.

4. Since it is impossible to predict and/or anticipate all and every scenario, condition and/or circumstances under which a product user may be exposed to risk and danger, the User Manual is not intended to be an exhaustive list on how to ride the vehicle safely and/or avoid hazards related to the vehicle. So, in addition to adhere to the instructions, the user shall also ride and/or use the vehicle with responsibility, carefulness, precaution and best judgment. The user should always be a responsible rider, cautious, maintain proper speed and avoid all dangerous riding behaviors, as well as traffic and/or road conditions when riding the vehicle. For instance, you shall avoid speeding, overloading or performing stunts of any kind. Do not try to touch the tires with your hands or feet when riding. Do not carry people on the rear rack. One rider only.

**5. The user shall check and obey the local laws or regulations over the vehicle. It is the sole user's responsibility that he/she shall ride, use and/or dispose of the vehicle in compliance with the law.** The law and regulations may be different in different jurisdictions. Apart from the others, such laws and regulation may include:

- (1) A helmet may be legally required by local law or regulation in your jurisdiction.
- (2) Vehicle registration and a license plate may be legally required by local law or regulation in your area.
- (3) Your eMoped may not be allowed to be driven in motorway or highway.

You may obtain more information related to legal requirements on eMoped from your local government.

6. A consumer shall immediately check whether the vehicle and its accessories are in good condition upon receipt of the vehicle.
7. All the separate components and part of the vehicles must be properly installed per the User Manual. Inappropriate installation and/or assembly may significantly increase the risk of loss of control, product failure, collisions and falls. The vehicle may contain removable components and small parts. Please keep them out of the reach of children to avoid choking hazard.
8. Do not dispose of this product in a landfill, by incineration, or by mixing with household trash. Serious danger/ injury can occur because of the electrical components and the battery. For information about battery and electrical waste, please contact your household waste disposal service, your local or regional waste management office, or your point-of-sale. The user shall not use any non-original accessories, or dismantle or modify the vehicle without authorization. All damages, injuries (including bodily injury and death) and damages to property arising therefrom will be your sole responsibility and risk.

9. **SEGWAY reserves the right to make changes to the vehicle, release firmware updates, and update this manual at any time.** Improvements and changes to this user manual necessitated by typographical errors, inaccuracies of current information, or improvements to programs and/or equipment, may be made by SEGWAY at any time and without notice. Such changes will, however, be incorporated into new editions of this user manual. All illustrations are for illustration purposes only and may not accurately depict the actual device. Actual product and functions may vary. Due to the update of the vehicle, there may be some deviations in color, appearance and other aspects between the vehicle listed in this manual and the vehicle you purchased. Please refer to the actual product.
10. This document should be considered as a permanent part of the vehicle and it shall be provided to the user together with the vehicle all the time.

Thank you again for choosing SEGWAY eMoped B110S!

## Appendix: Installation of the Rear-view Mirrors

- a. Align the mirror for the installation position on the handle bar, rotate and tighten the support bolt in the clock wise direction.

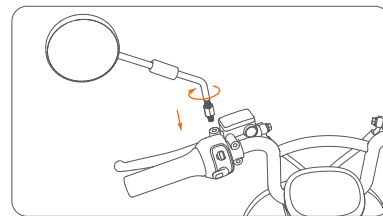

- b. Rotate the mirror and the (upper) counter bolt in the counter-clockwise direction.

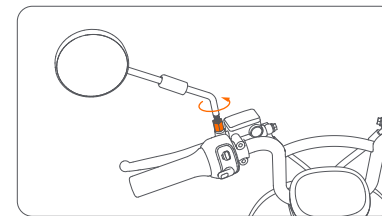

- c. Use an open-end wrench to tighten both bolts to securely fasten the mirror.

