



**T-REX50/110**

**SERVICE MANUAL**



**PGO SCOOTERS**

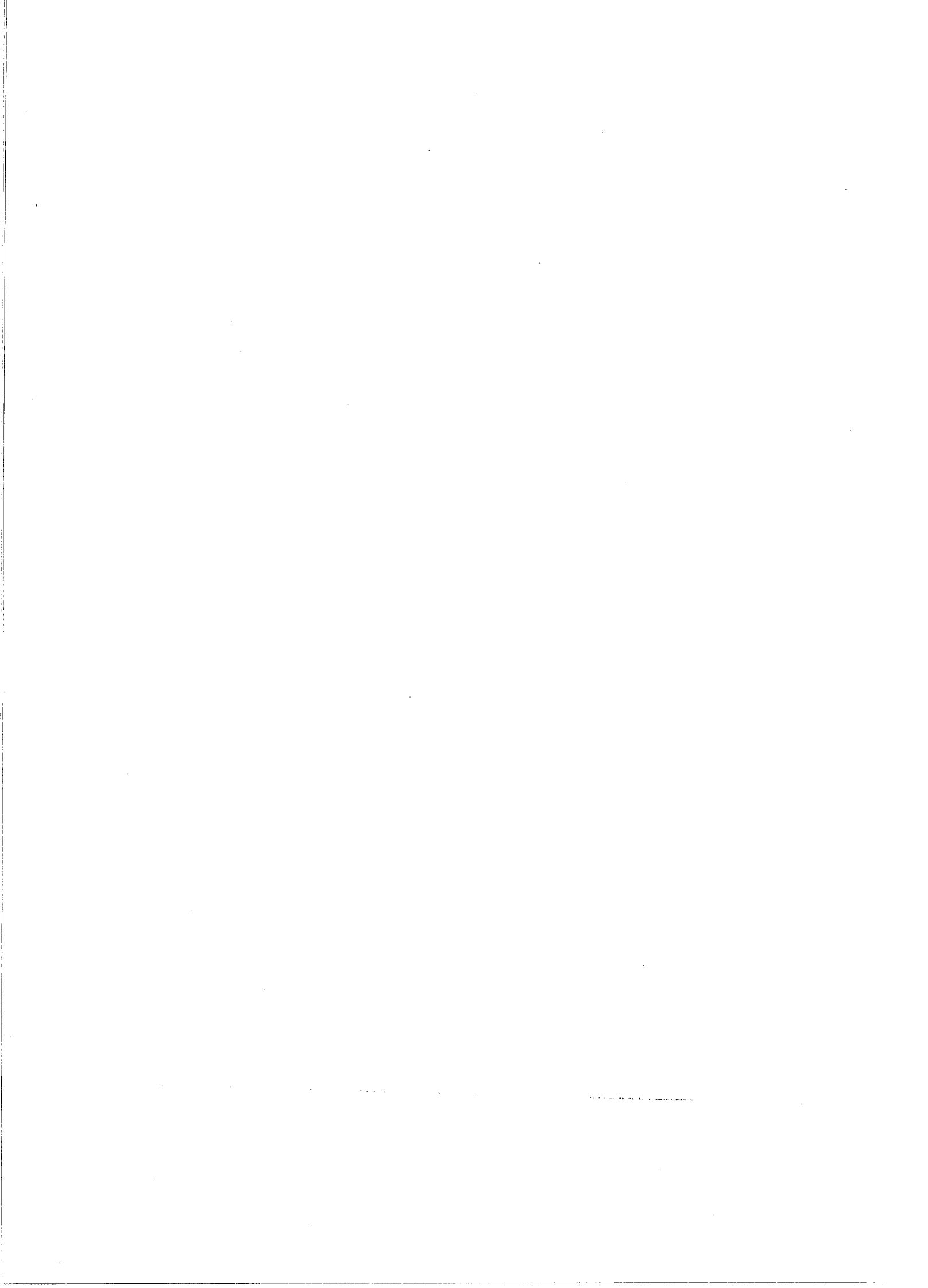

## **PREFACE**

This manual provides every service specialist with the professional techniques of maintenance and repairing for T-REX 50/110. It provides a detailed guide for those who may concern with how to maintain, repair, reassemble, and change parts of their scooters.

At every section, we illustrate each important point by assembling procedures, explosive diagrams and photographs.

Although we have tried our best to make this manual as perfect as possible, please kindly inform us if any fault needs to be corrected in this manual.

Thank you for purchasing our PGO scooters.

FACTORY:

Motive Power Industry Co.,Ltd.

SOLE EXPORT AGENT:

Societe Commerciale Euro-Taiwanaise

# CONTENTS:

	Page
I .The specification of T-REX 50/1W .....	4
II .Service information .....	6
(1)The operation notice.....	7
(2)Locking torque value.....	8
(3)Lubrication instruction.....	10
(4)Wiring diagram.....	13
(5)Troubleshooting .....	14
III .Checking and adjustment .....	25
(1)Regular Checking table.....	26
(2)Battery .....	30
(3)Cleaning air cleaner.....	31
(4)The final reduction mechanism oil .....	32
(5)Spark plug.....	32
(6)Compression pressure measurement.....	33
(7)Ignition timing .....	34
(8)Throttle cables adjustmen .....	34
(9)Idle Adjustment .....	35
(10)Front brake adjustment.....	35
(11)Rear brake adjustment .....	36
(12)Tire.....	36
IV .Dismantling, maintaining, repairing and assembling operation.....	37
(1)Lubrication system.....	38
(2)Plastic parts .....	41
(3)Engine dismantling.....	46
(4)Drive pulley, starter, clutch .....	47
(5)Cylinder and piston .....	56
(6)AC generator.....	65
(7)Final transmission mechanism.....	67
(8)Crankcase, crank shaft.....	71
(9)Carburetor, reed valve, auto cock .....	78
(10)Steering column, front wheel, front brake comp, front fork.....	83
(11)Rear wheel, rear brake, rear damper .....	92
(12)Fuel tank, oil tank .....	96

V. Electric equipment .....	100
(1) Troubleshooting .....	101
(2) Battery .....	102
(3) Recharge system .....	105
(4) Ignition system .....	107
(5) Starting system .....	109

I.

# SCOOTER SPECIFICATION

Name	T-REX 110	Frame	Steel pipe
Type	CP-110DS	SUSPENSION SYSTEM	
DIMENSION		Front	Telescopic
Overall length	1870mm	Rear	4-bar linkage, uni-absorber
Overall width	815mm	TRANSMISSION	
Overall height	1286mm	Primary reduction	Direct drive
Wheel	1284mm	Secondary ratio	49/16*43/13
DRY WEIGHT		Clutch	centrifugal
Front	42KG	Type	CVT
Rear	60KG	TIRE	
Total	102KG	Front	120/70-12
Load	2 PERSON(75Kg*2)	Rear	130/70-12
LOADED WEIGHT		BRAKE SYSTEM /	
Front	90kg	Front	Hydraulic disk brake
Rear	162kg	Rear	Drum brake
Total	252kg	LIGHT	
ENGINE		Head light(H/L)	12V18W*18W*2
Type	PO	Tail light	12V3W
Fuel	SUPER/unlead	Braking light	12V10W
Cyl	1	Signal light	12V10W
bore	52.0mm	Horn	AC 12V
Stroke	50.0mm	Silencer	Diffusible absorption closed type
Arrangement	Horizontal		
Displacement	106.2cc		
Compression ratio	6.6:1		
MAX Power/rpm	6.6kw/7000rpm		
MAX Torque/rpm	9.0N-M/6750rpm		
Ignition	CDI		
Starting	kick or electric start		
Cooling	Forced air cooling		
Lubrication	Separate		
VEHICLE PERFORMANCE			
Top speed	92km/hr		
Fuel consumption	37.0km/liter		
Clearance	22degree		

## SCOOTER SPECIFICATION

Name	T-REX 50/110	Frame	Steel pipe
TYPE	CP-50DS	SUSPENSION SYSTEM	
DIMENSION		Front	Telescopic
Overall length	1870mm	Rear	4-bar linkage, uni-absorber
Overall width	815mm	TRANSMISSION	
Overall height	1286mm	Primary reduction	Direct drive
Wheel base	1284mm	Secondary ratio	52/13*44/13 / 49/13*13
DRY WEIGHT		Clutch	centrifugal
Front	41KG / 42kg	Type	CVT
Rear	58KG / 60kg	TIRE	
Total	99KG / 102kg	Front	120/70-12
Load	1 PERSONS(75kg)	Rear	130/70-12
LOADED WEIGHT		BRAKE SYSTEM	
Front	65kg / 90kg	Front	hydraulic disk brake
Rear	109kg / 162kg	Rear	Drum brake
Total	174kg / 252kg	LIGHT	
ENGINE		Head light(H/L)	12V-18W*2/18w*2
Type	P2 / P0	Tail light	12V3W
Fuel	SUPER/unlead	Braking light	12V10W
Cylinder	1	Signal light	12V10W
Bore:	40.0mm/52.0	EMISSION	
Stroke:	39.2mm/50.0	Horn	AC12V
Arrangement	Horizontal	Silencer	Diffusible absorption closed type
Displacement	49cc / 106.7		
Compression ratio	6.8:1 / 6.6:1		
MAX. power/rpm	3.7kw/6750rpm	6.6kw, 7000rpm	
MAX. torque/rpm	5.0N-N-M/7000rpm	9.0Nm @ 6750rpm	
Ignition	CDI		
Start	kick or electric start		
Cooling	Forced air cooling		
Lubrication	Separate		
VEHICLE PERFORMANCE			
Top speed	65km/hr	92 km/h	
Fuel consumption	39.0km/liter	37.0 km/l	
Climbing ability	19degree	22 degree	

## II. Service information:

(1)The operation notice.....	7
(2)Locking torque value.....	8
1.For engine	
2.For chassis	
3.Others	
(3)Lubrication instruction .....	10
a.For engine	
b.For chassis	
c.Wheel bearing	
(4)Wiring diagram.....	13
(5)Troubleshooting .....	14
1.Difficult starting or no starting	
2.Weak acceleration	
3.Engine running not smoothly(Low speed)	
4.Engine running not smoothly(high speed)	
5.Clutch, driving & driven pulley	
6.Handlebar steering was astray when running	
7.Front and rear damper not balanced	
8.Brake disorder	
9.Oil indicator malfunction	
10.Fuel indicator malfunction	
11.Starting motor malfunction	
12.No sparking	
13.Charging abnormal	



(1)The operation notice:

- 1.For parts like the gasket, O-ring, clips and circlets, please change a new part whenever re-assembled.
- 2.When trying to tighten screws or nuts, please lock tightly according to each recommended locking torque and in the sequence of the "X" pattern.
- 3.Please use PGO or PGO recommended parts.
- 4.After dismantling, please clean all parts involved or used for checking and grease all contact surfaces when reassembling.
- 5.Use grease recommended by PGO.
- 6.When removing the battery, please disconnect the negative pole(-) first. However, please connect the positive pole(+) first when assembling.
- 7.Before installing a new fuse, please be sure that the specification is correct.
- 8.After reassembling, please re-confirm that all connecting points, locking parts, circuits, polar characteristics are functioning well before selling out.

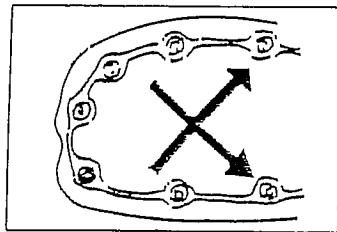

screw, nut locking,  
please use x pattern  
type.

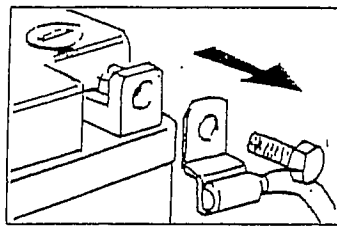

first remove the  
negative cable(-)

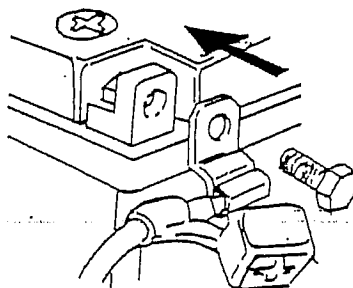

first connect the positive  
cable(+)

## (2) Locking torque value:

### 1. Engine

No	locking location	Thread dia(mm)	Locking torque kg-m	Remarks	
1	cylinder head	7	1.0-1.4	When the engine is cold	
2	flywheel plate	10	3.2-4.0		
3	rear brake lever	6	1.0-1.2		
4	driving pulley	10	3.2-4.0		
5	clutch outer	10	3.5-4.0		
6	right crankcase	6	1.0-1.2		
7	drive gear box cover	6	1.0-1.2		
8	left crankcase	6	1.0-1.2		
9	draining and filler bolt	8	1.8		When the engine is cold
10	inlet pipe	6	1.0-1.2		
11	flywheel magneto	6	1.0-1.2		
12	cooling fan	6	1.0-1.2		
13	muffler nut on cylinder head	6	1.0-1.2		When the engine is cold
14	starting motor	6	1.0-1.4	When the engine is cold	
15	bracket between eng. and rubber pad of central stand	6	1.0-1.2		
16	spark plug	14	2.5-3.0		
17	fan cover	6	1.0-1.2		
18	fixed plate, drive clutch	6	1.0-1.4		
19	nut of rear wheel axle	14	11-13	U TYPE NUT	
20	kick starter	6	1.0-1.2		

### 2. Chassis

1	steering stem nut	10mm	3.0-4.0	lock nut
2	front axle nut	12mm	5.0-6.0	(U type nut)
3	fixed nut fasten eng. and chassis	12mm	5.0-6.0	(U type nut)
4	rear shock absorber (upper)	10mm	3.0-4.0	
	rear shock absorber (lower)	8 mm	2.0-3.0	
5	lock nut fasten frt. brake disk and frt. wheel rim	8 mm	2.0-3.0	lock nut
6	lock bolt between frt. brake pump and frt. absorber	8 mm	2.0-3.0	lock bolt

3. Other parts standard torque values:

No	Item	Torque kg-m
1	5 mm bolt and nut	0.45-0.6
2	6 mm bolt and nut	0.8-1.2
3	8 mm bolt and nut	1.8-2.5
4	10mm bolt and nut	3.0-4.0
5	12mm bolt and nut	5.0-6.0
6	5 mm screw	0.35-0.5
7	6 mm screw	0.7-1.4
8	6 mm flange bolt and screw	1.0-1.4
9	7 mm flange bolt and screw	1.0-1.4
10	8 mm flange bolt and screw	2.0-3.0
11	10mm flange bolt and screw	3.0-4.0

### (3) Lubrication instruction

#### A. Engine

NO	Lubrication location	Oil type	Remarks
1	crankcase:rotating part, sliding part	premium 2 stroke motorcycle oil or SAE#30	Auto-separated Lubrication
2	cylinder:rotating part, sliding part.		
3	drive gear box	SAE85-140	Total 110 c.c. Replacement 90c.c
	Reverse gear box	SAE85-140	Total 250 c.c. Replacement 220c.c
4	gasket of starter shaft	clean grease	(#3)
5	start idle gear sliding parts	clean grease	(#3)

B. Chassis

Steel ball, steering stem

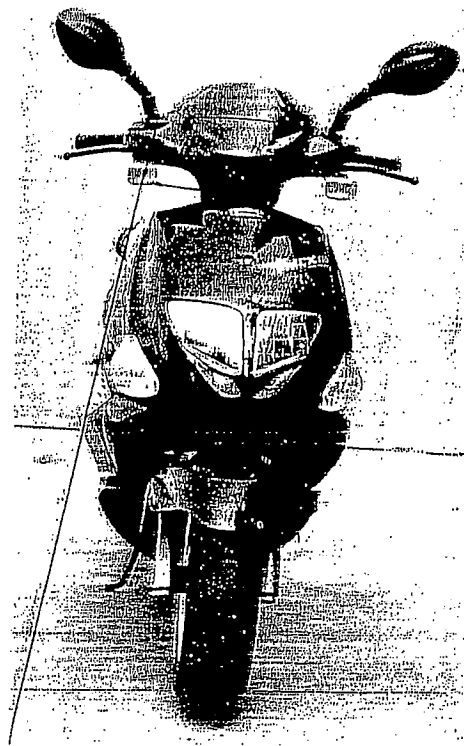
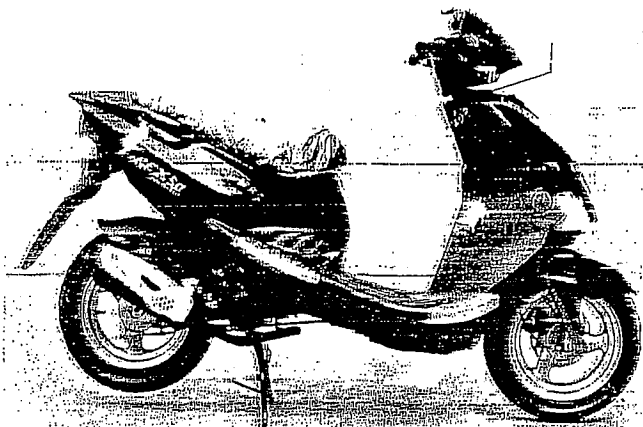

Front brake fluid

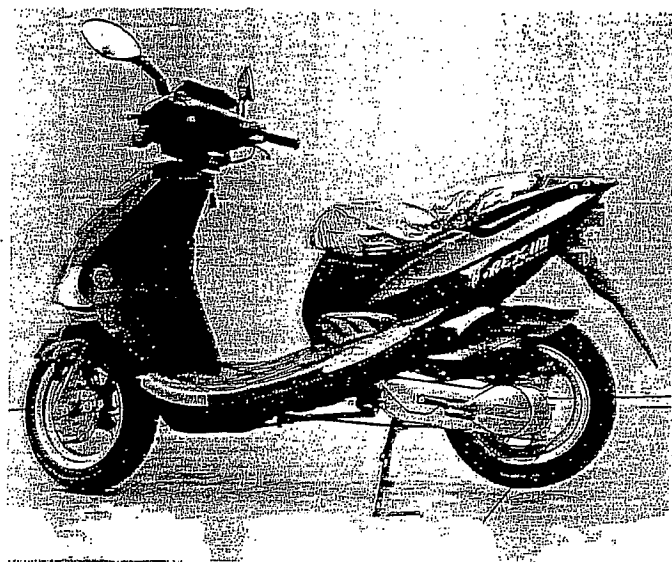

C. Wheel bearing

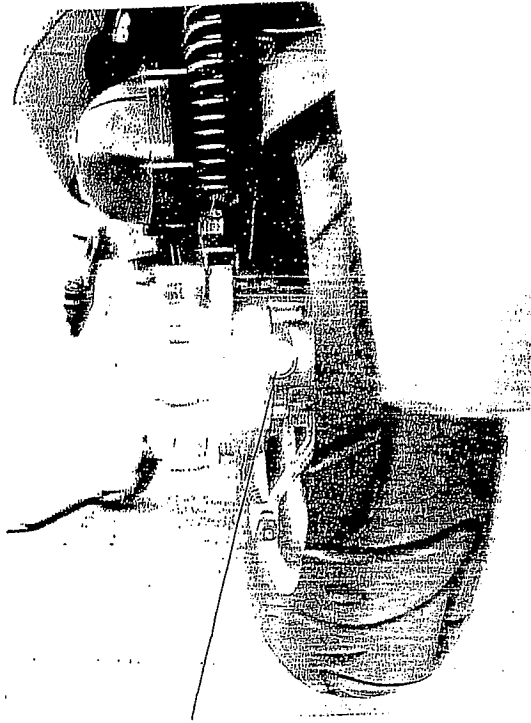

Final transmission mechanis-gear oil

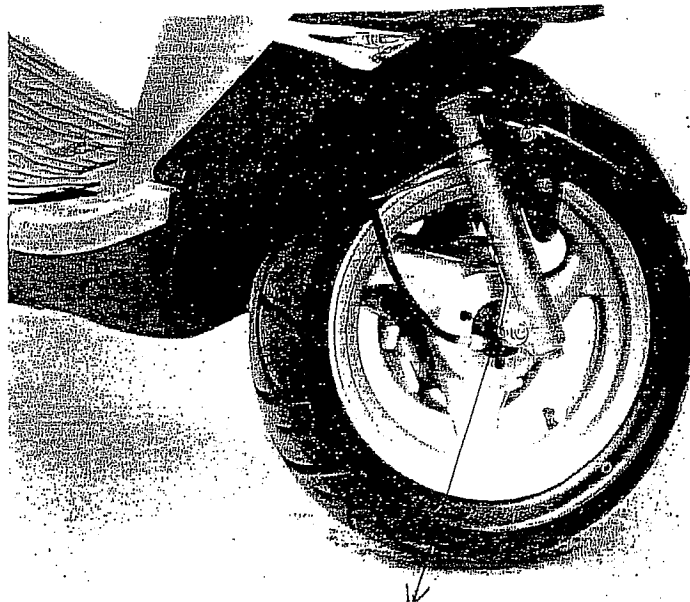

speedometer gear-clean grease

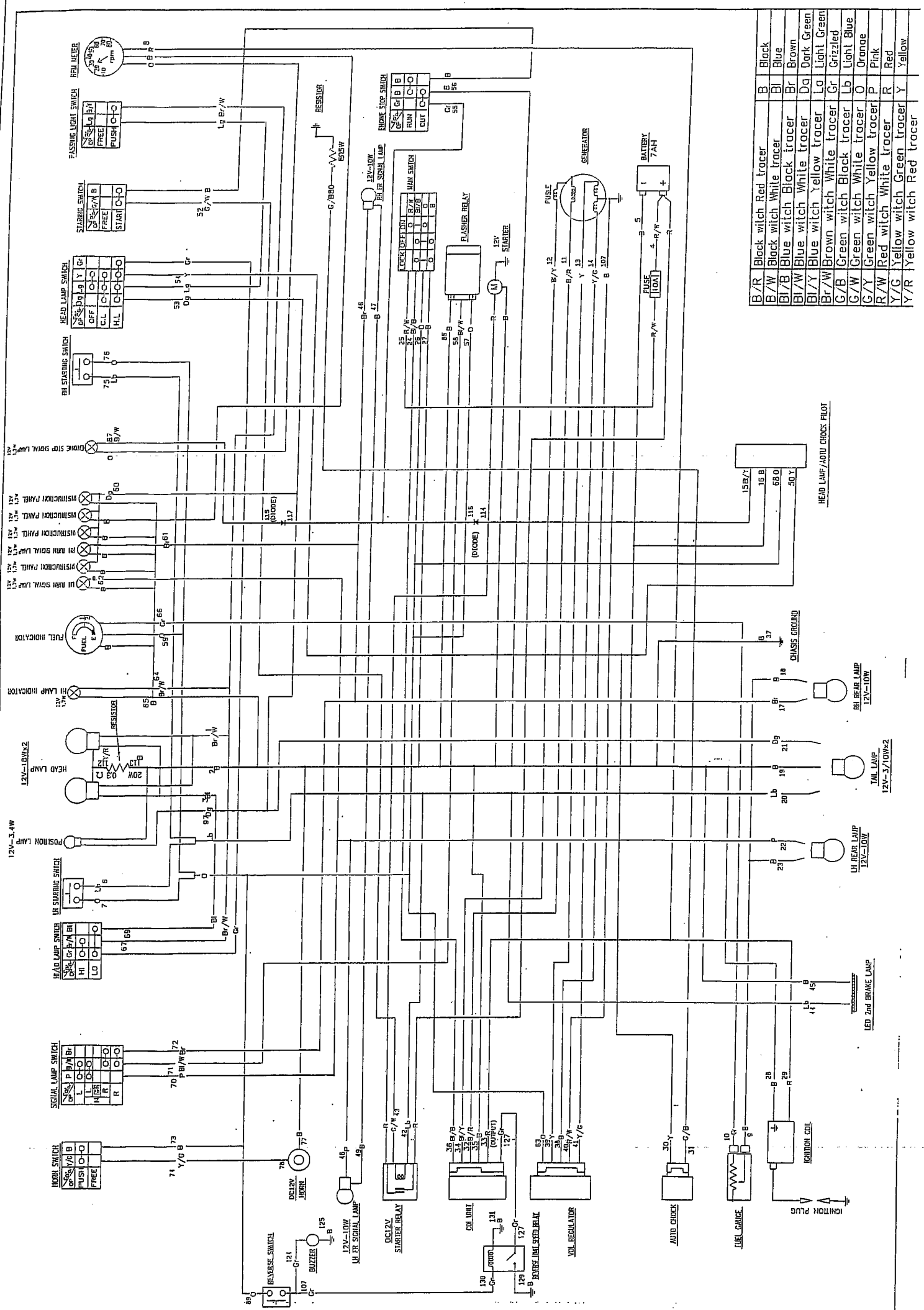

B/R	Black w/itch	Red tracer	B	Black
B/W	Black w/itch	White tracer	Bl	Blue
Bl/B	Blue w/itch	Black tracer	Br	Brown
Bl/W	Blue w/itch	White tracer	Dg	Dark Green
Bl/Y	Blue w/itch	Yellow tracer	La	Light Green
Br/W	Brown w/itch	White tracer	G	Grizzled
G/B	Green w/itch	Black tracer	Lb	Light Blue
G/W	Green w/itch	White tracer	O	Orange
R/W	Red w/itch	White tracer	P	Pink
Y/G	Yellow w/itch	Green tracer	R	Red
Y/R	Yellow w/itch	Red tracer	Y	Yellow

## (5) Trouble shooting:

### 1. Difficult starting or can't start:

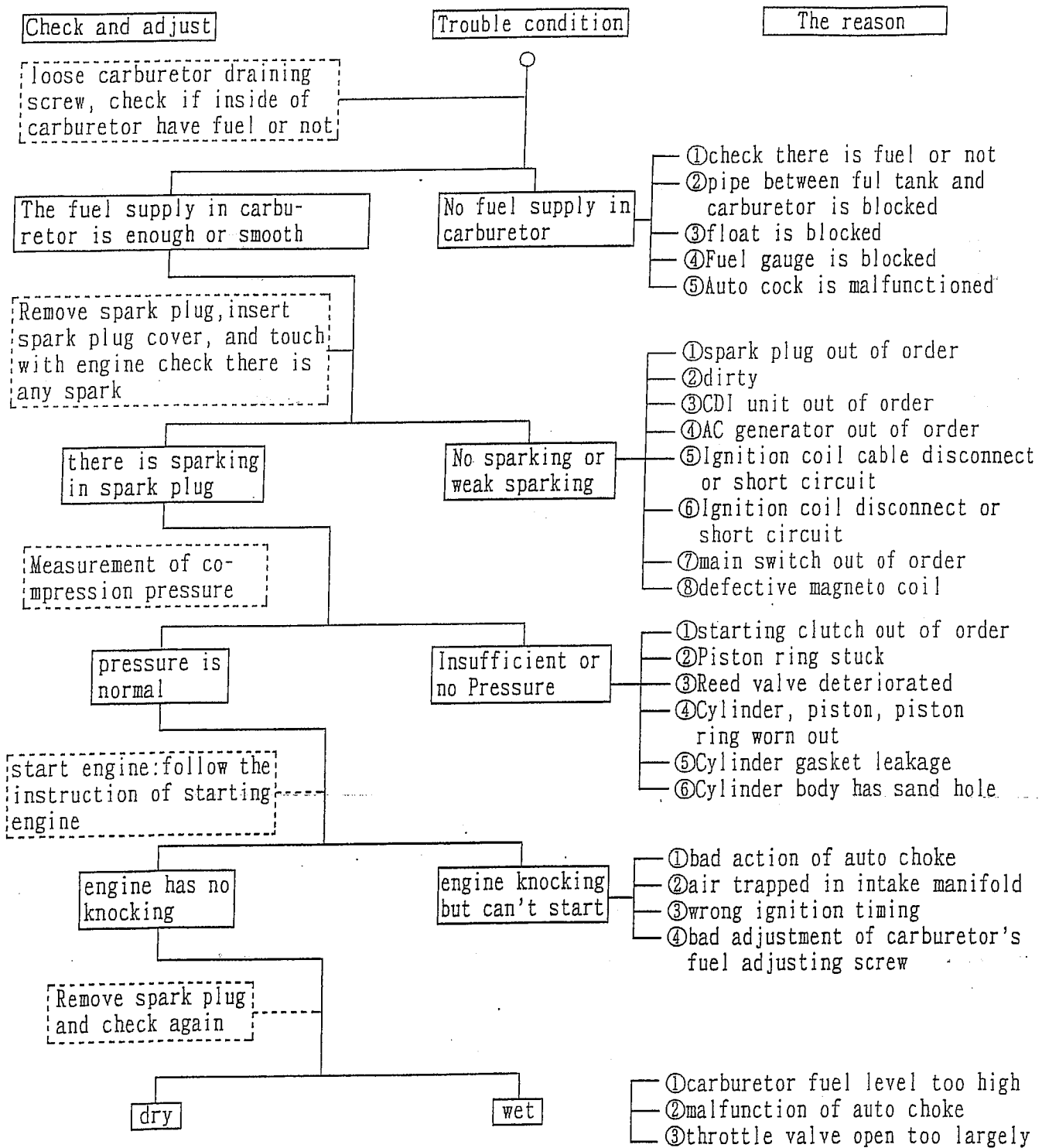



2. Weak acceleration:

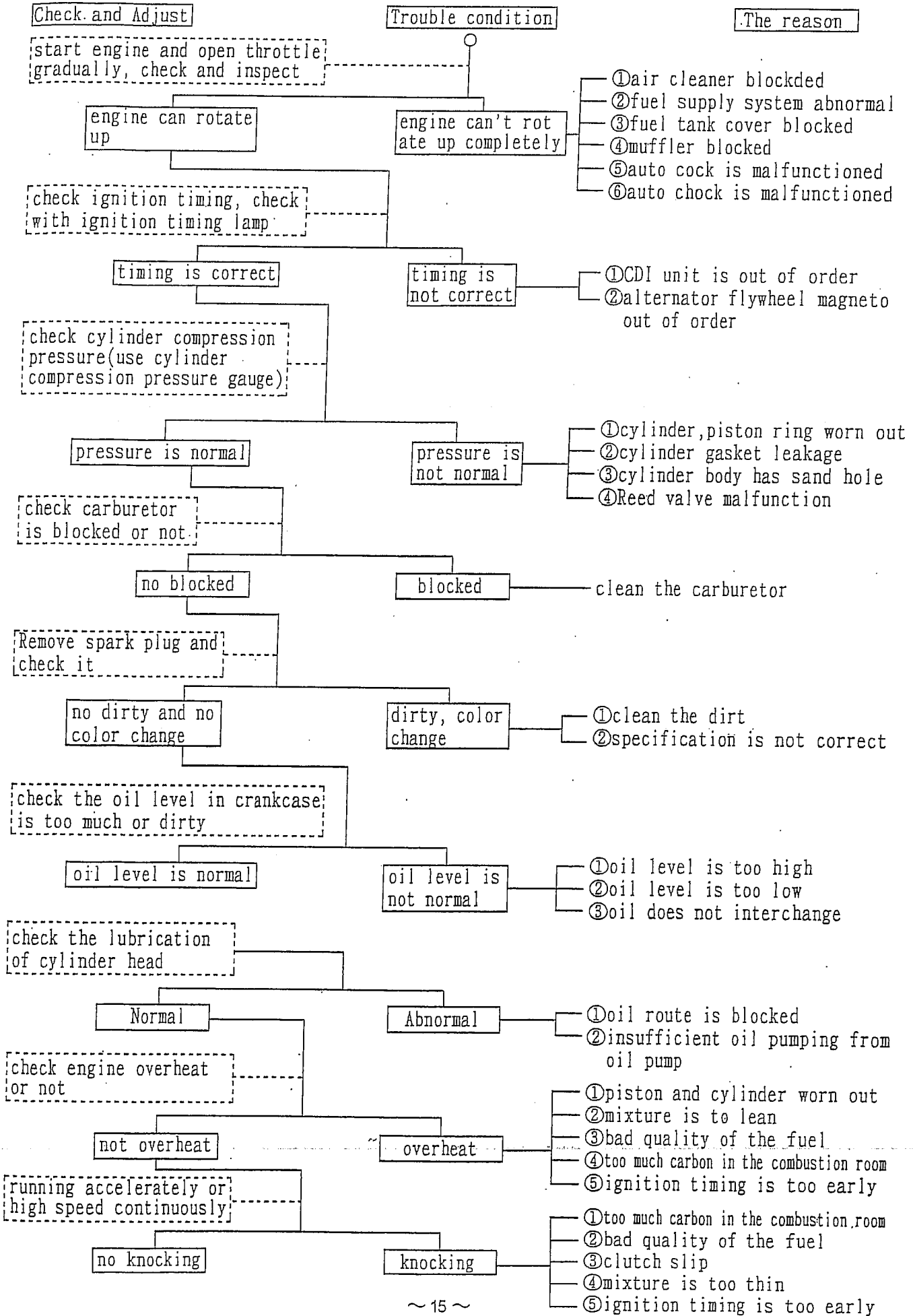

### 3. Engine running unsmoothly (low speed and idling)

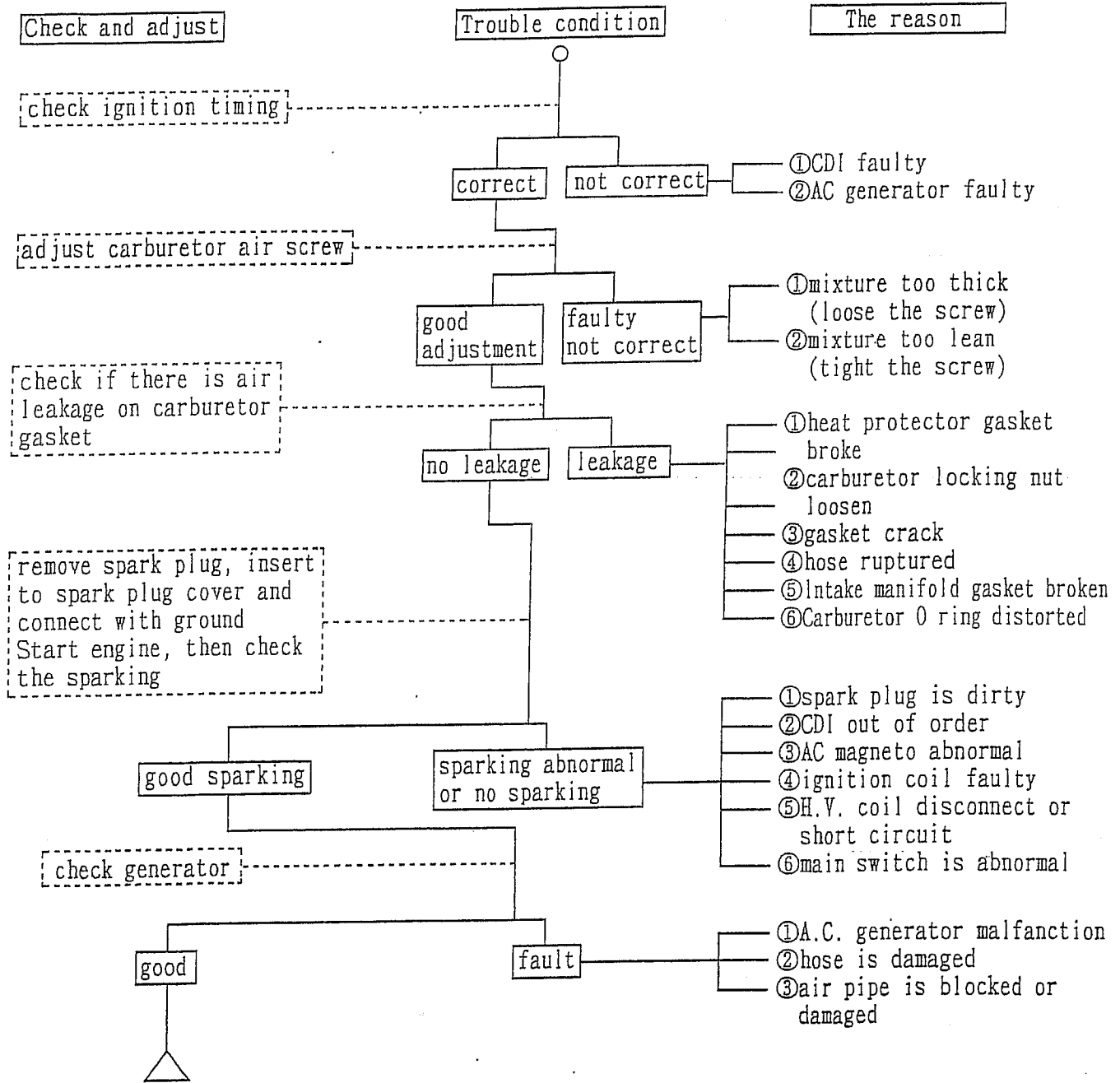

4. Engine running not unsmoothly (high speed)

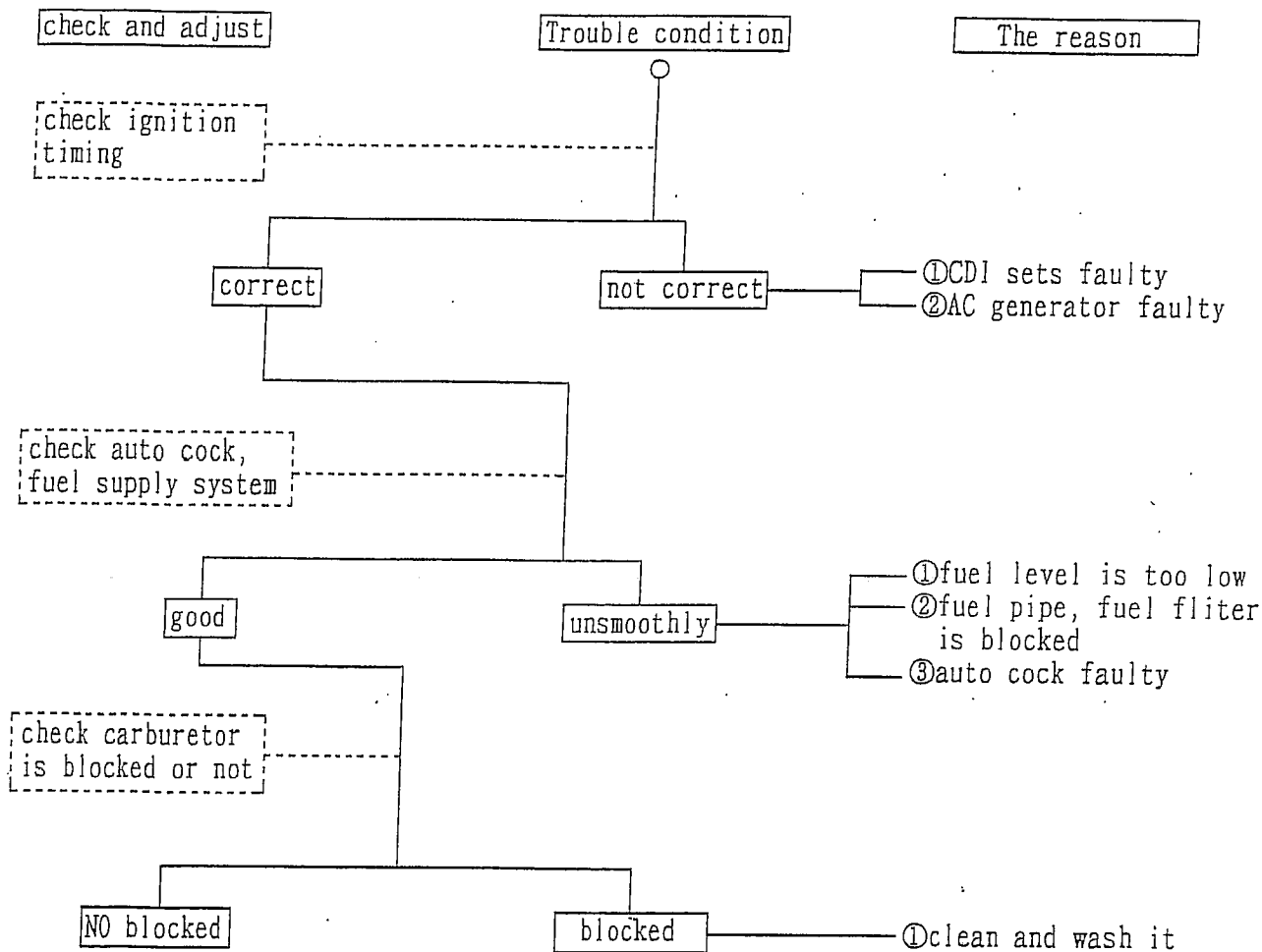

5. Clutch, drive & driven pulley

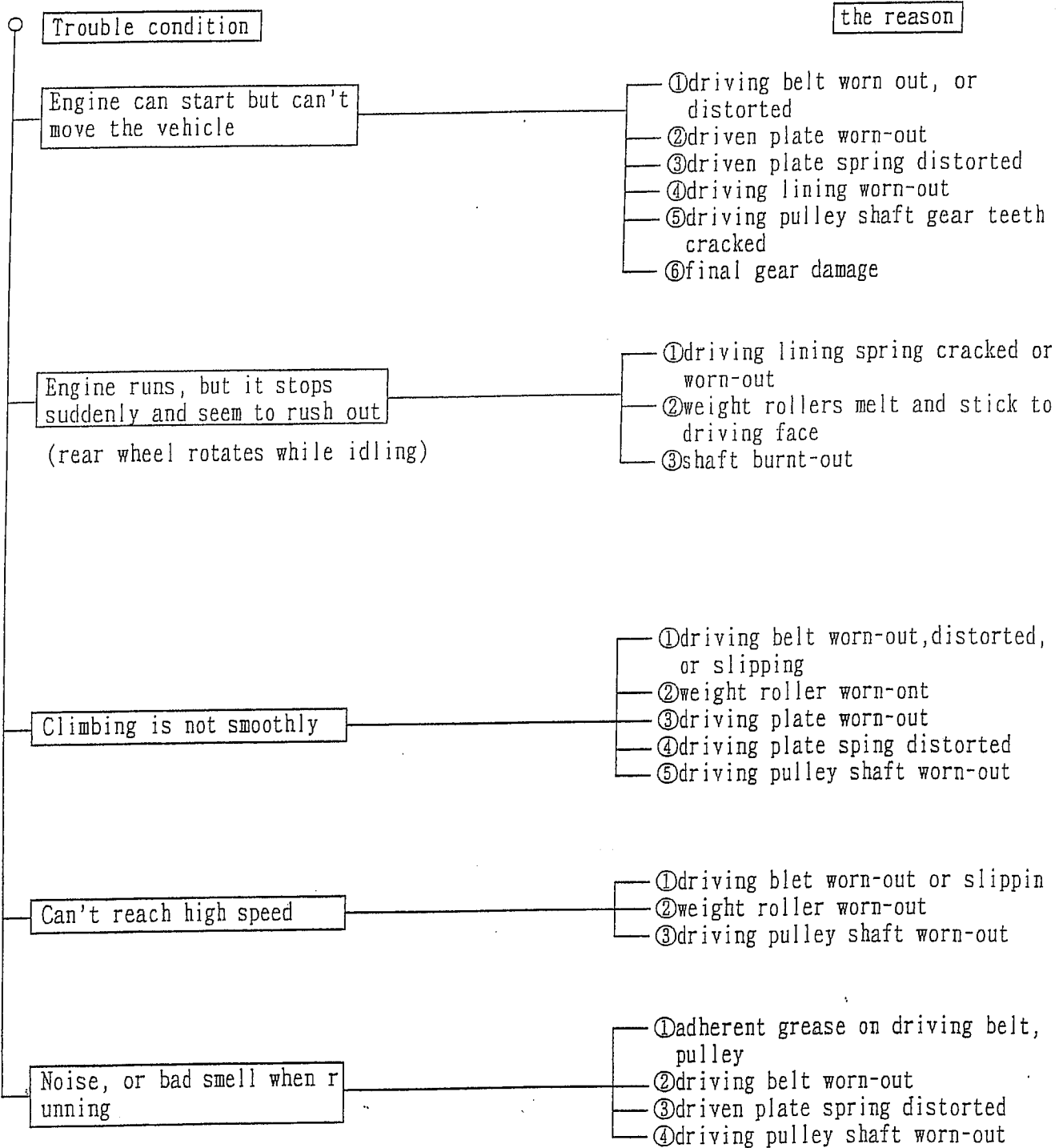

6. Handlebar steering was astray when running.

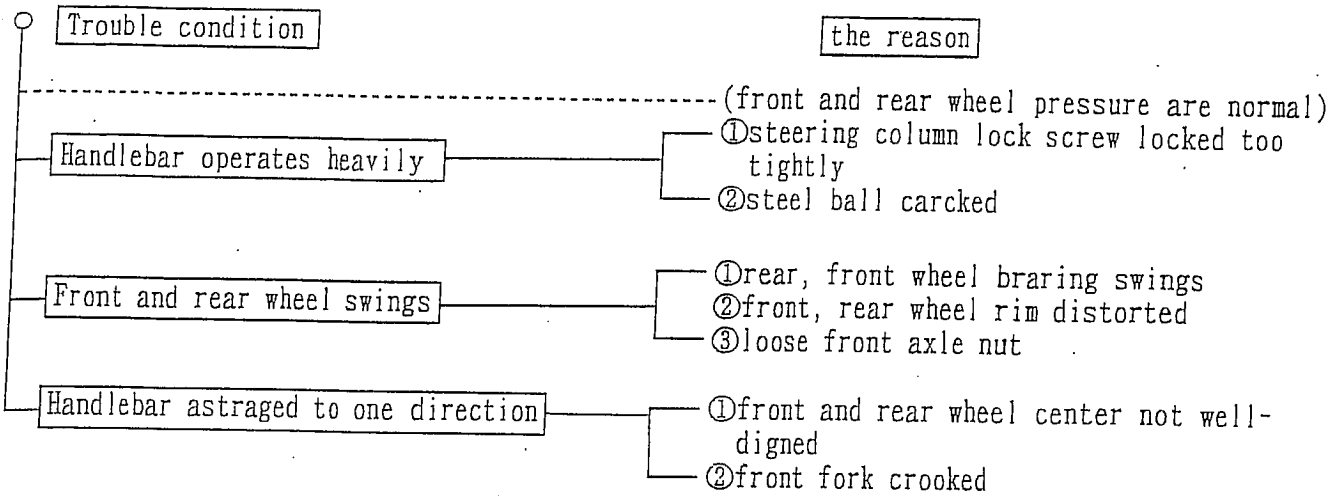

7. Front, rear damper not in balanced

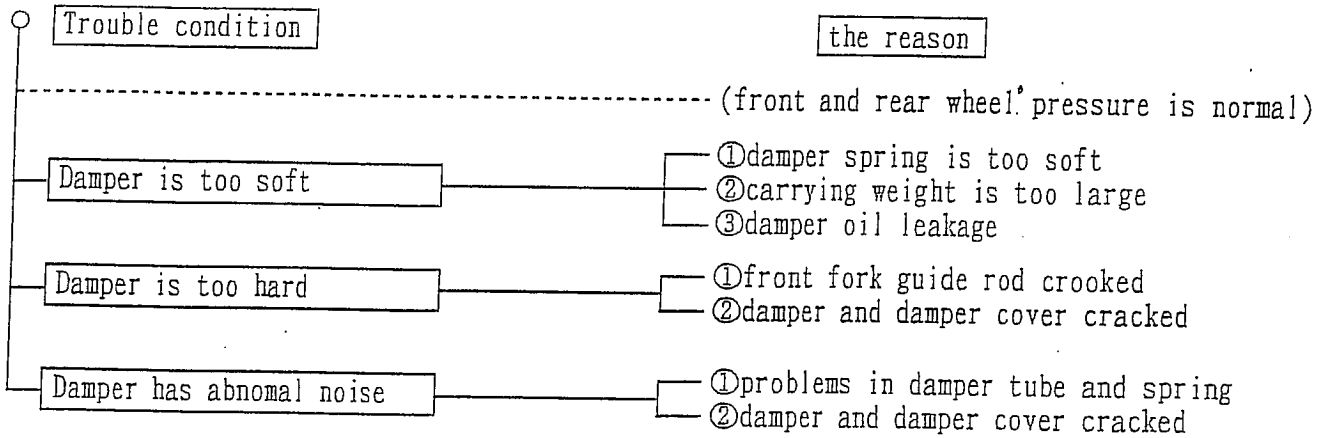

8. Brake disorder.

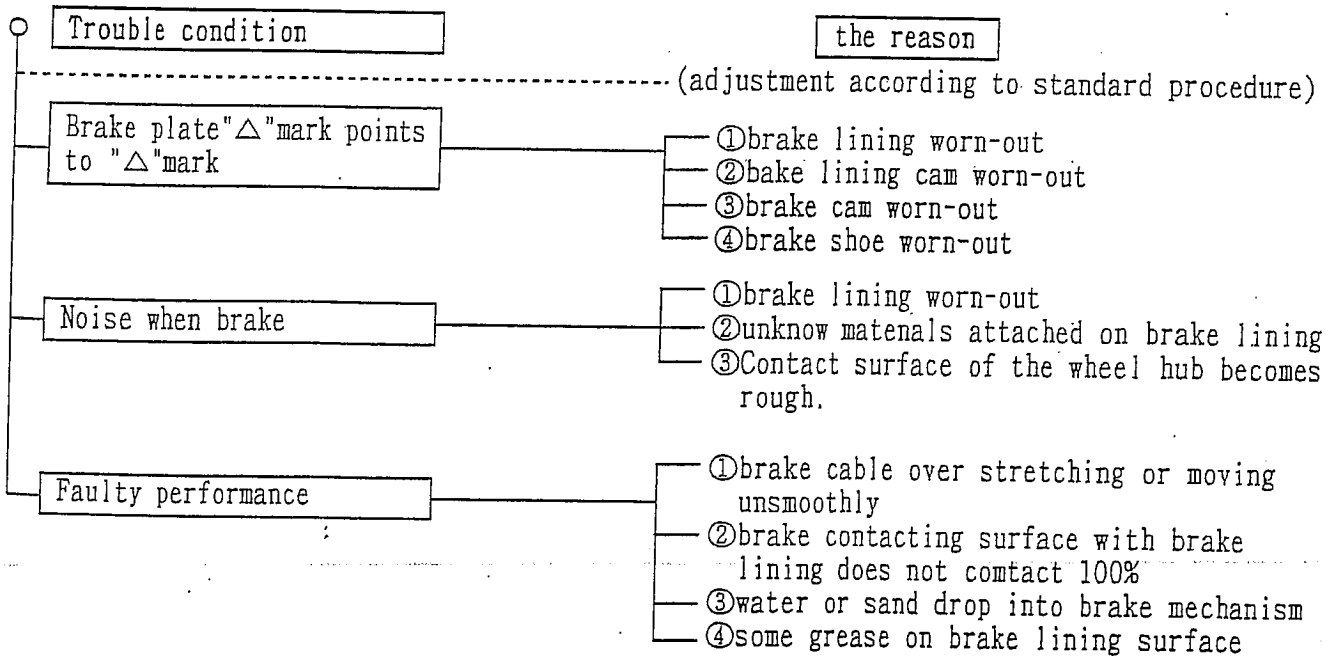

⑨. Oil indication malfunction

(a) The oil lamp doesn't light up, (when the main switch is at "ON" position)

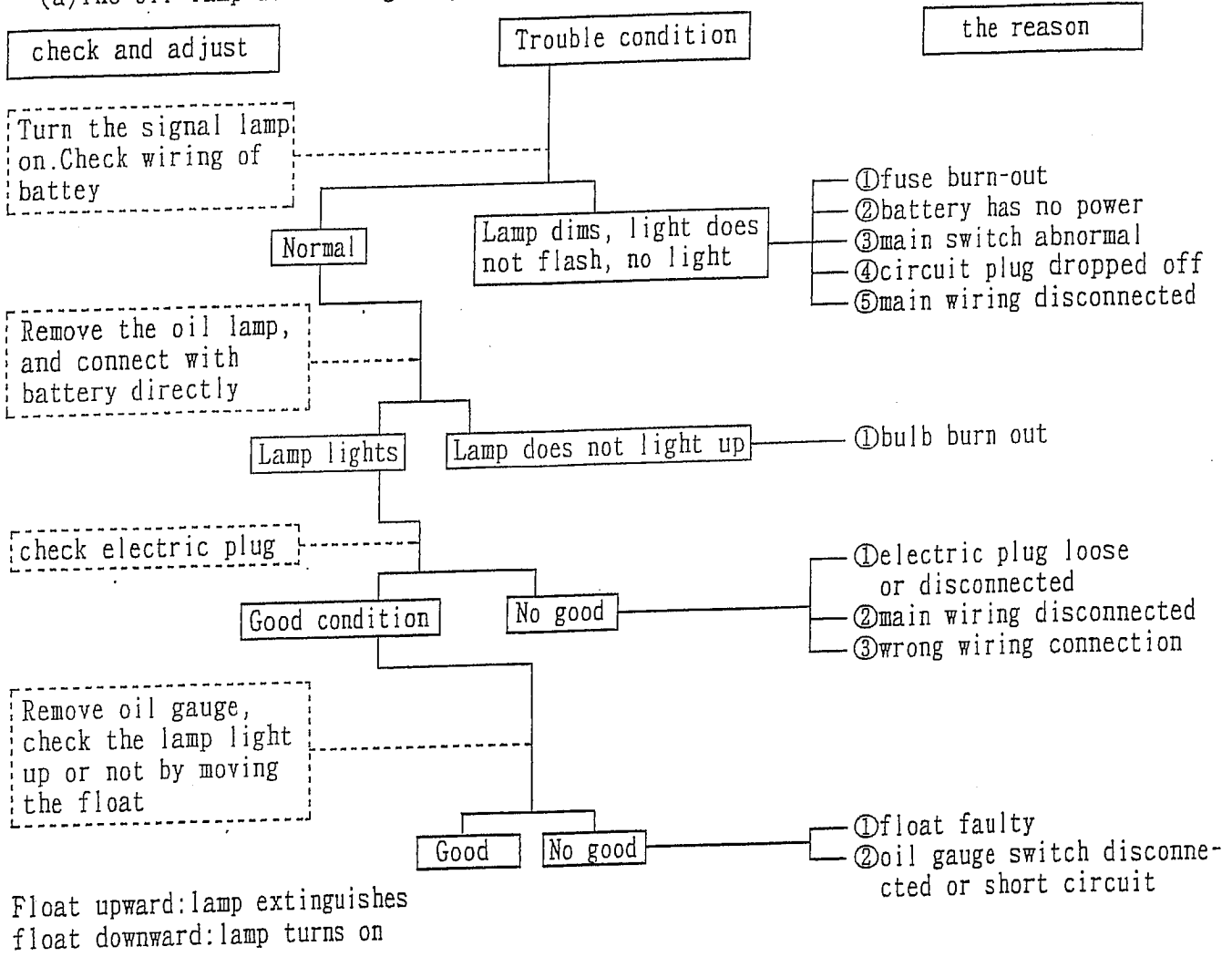

(b) Oil is enough but the indicator turns on all the time (when the main switch is "ON")

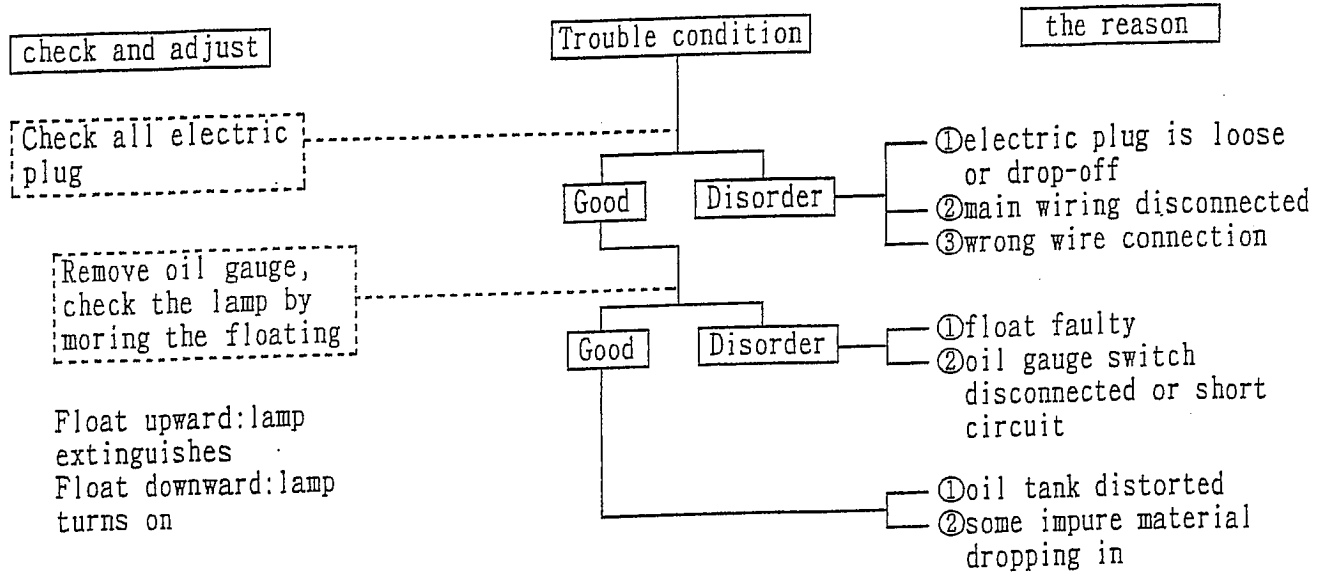

10. Fuel Indication unalfanction

(a) Wrong fuel level indicafion(when the main switch is "ON")

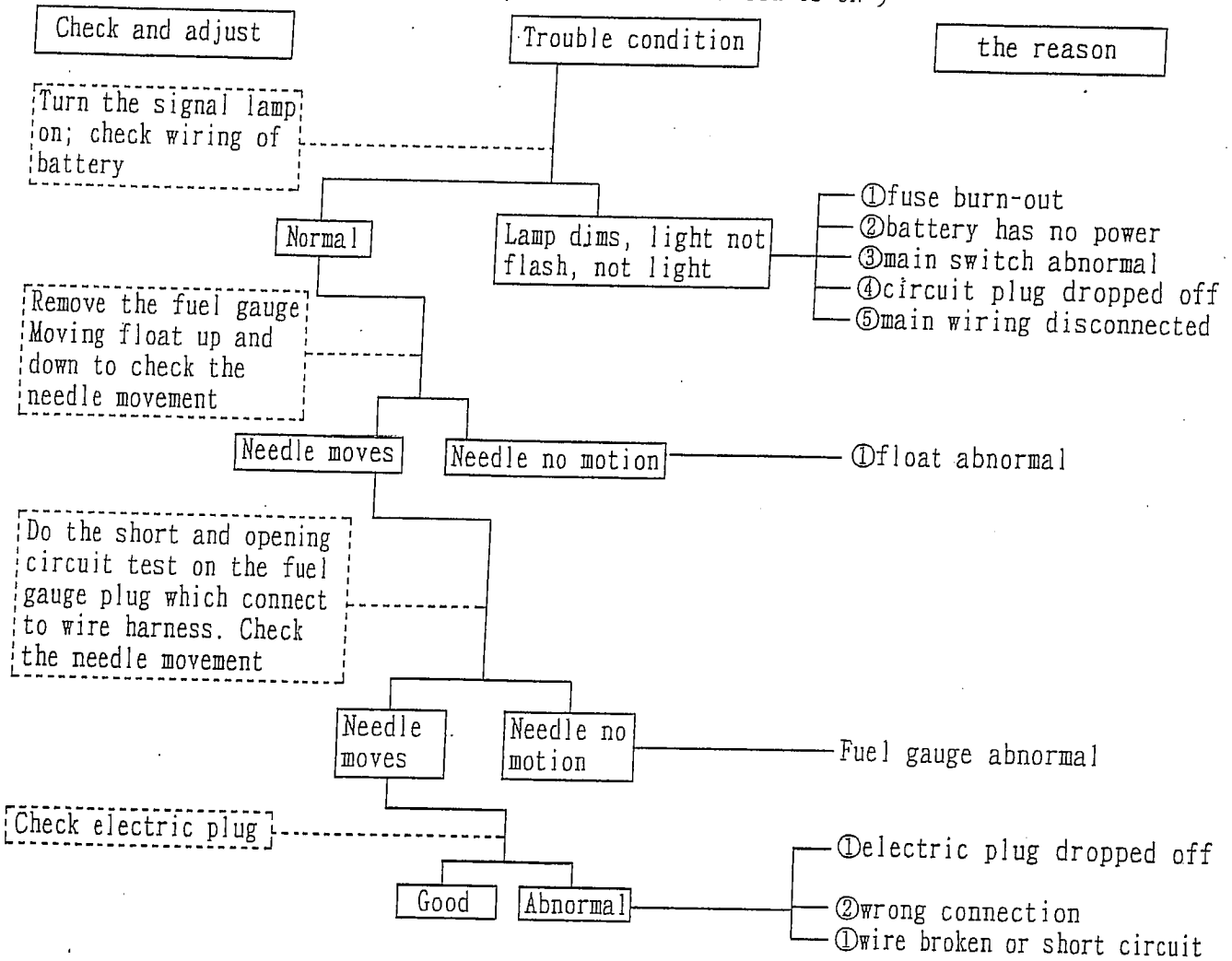

(b) Fuel gauge needle is not steady and sometimes moves up and down(when the main switch is "ON")

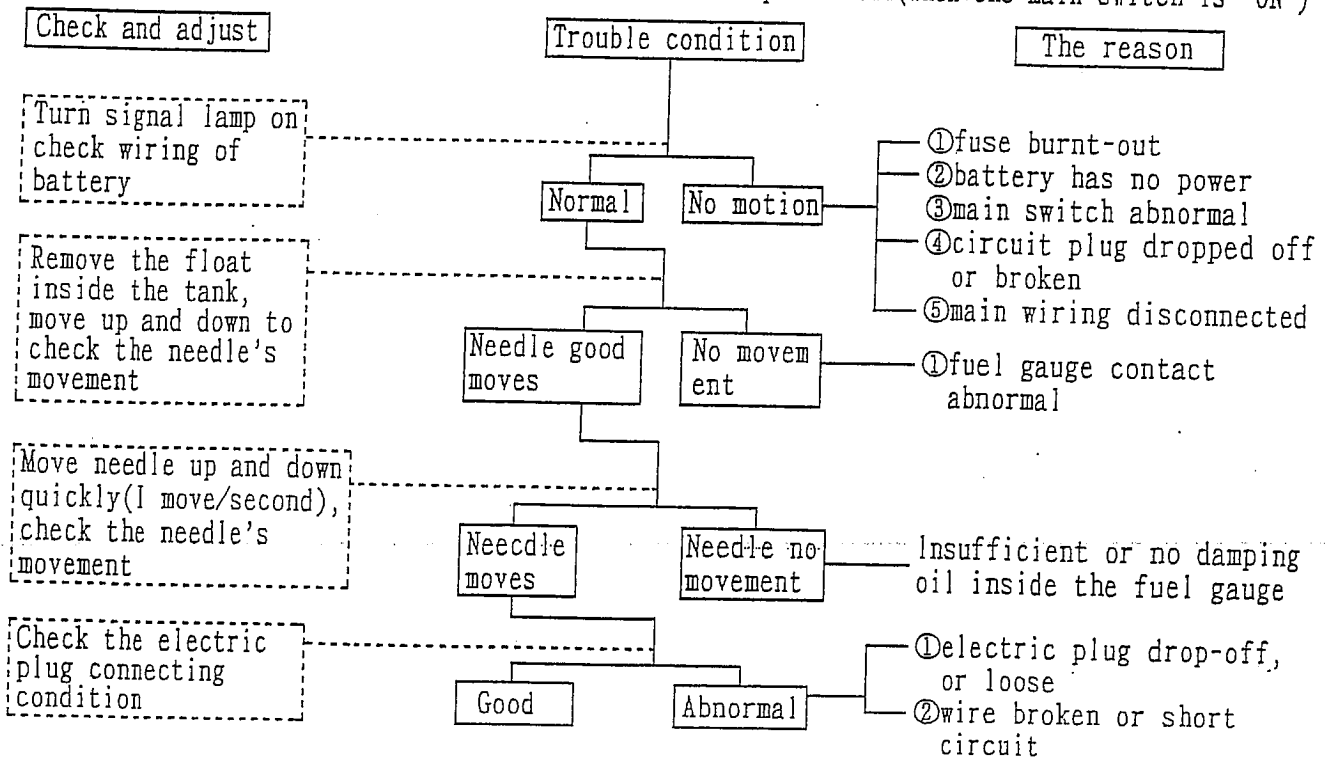

# 11. The starting motor abnormal

## (a) Starting motor can not rotate

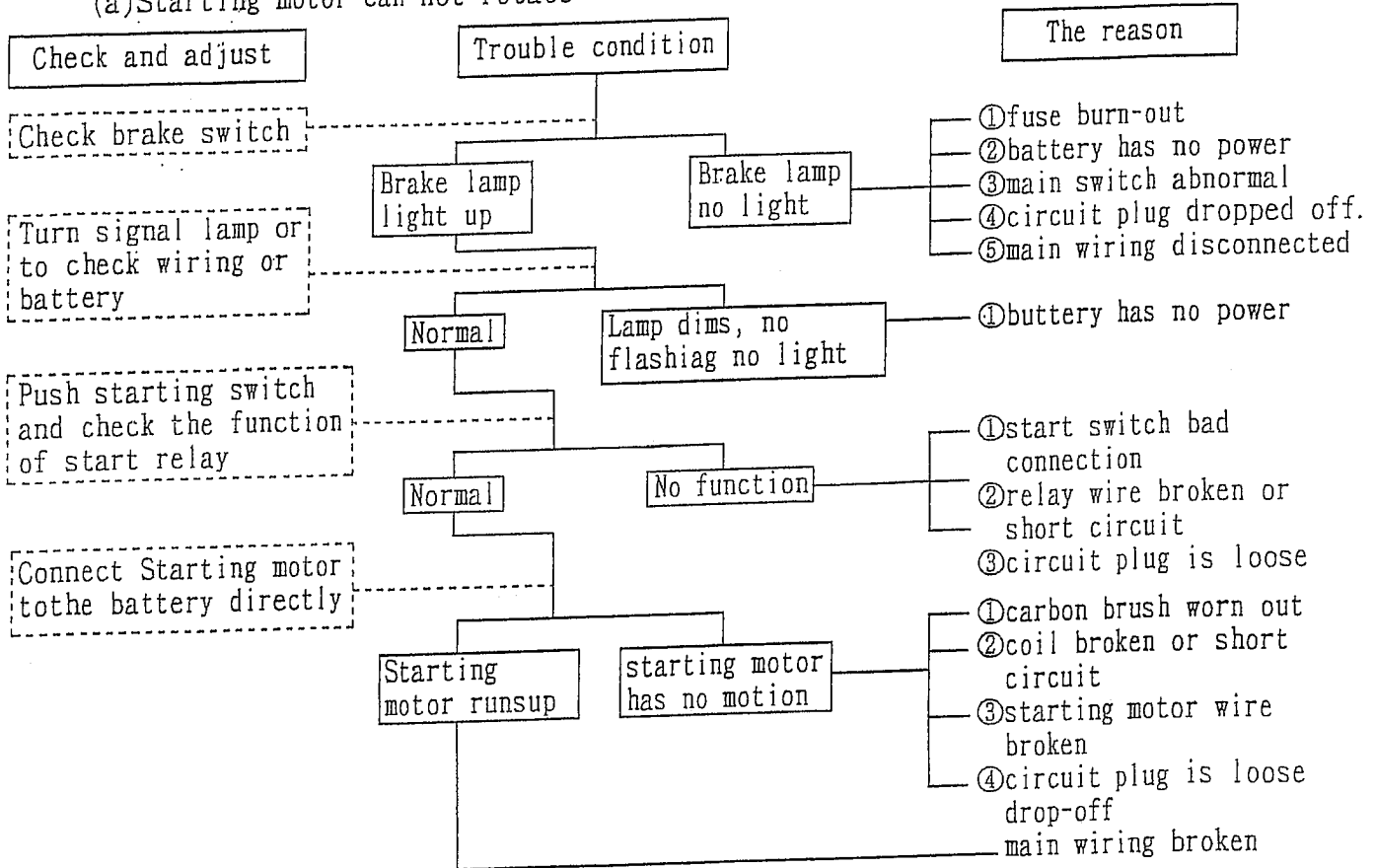

## (b) Starting motor running slowly or no pick-up

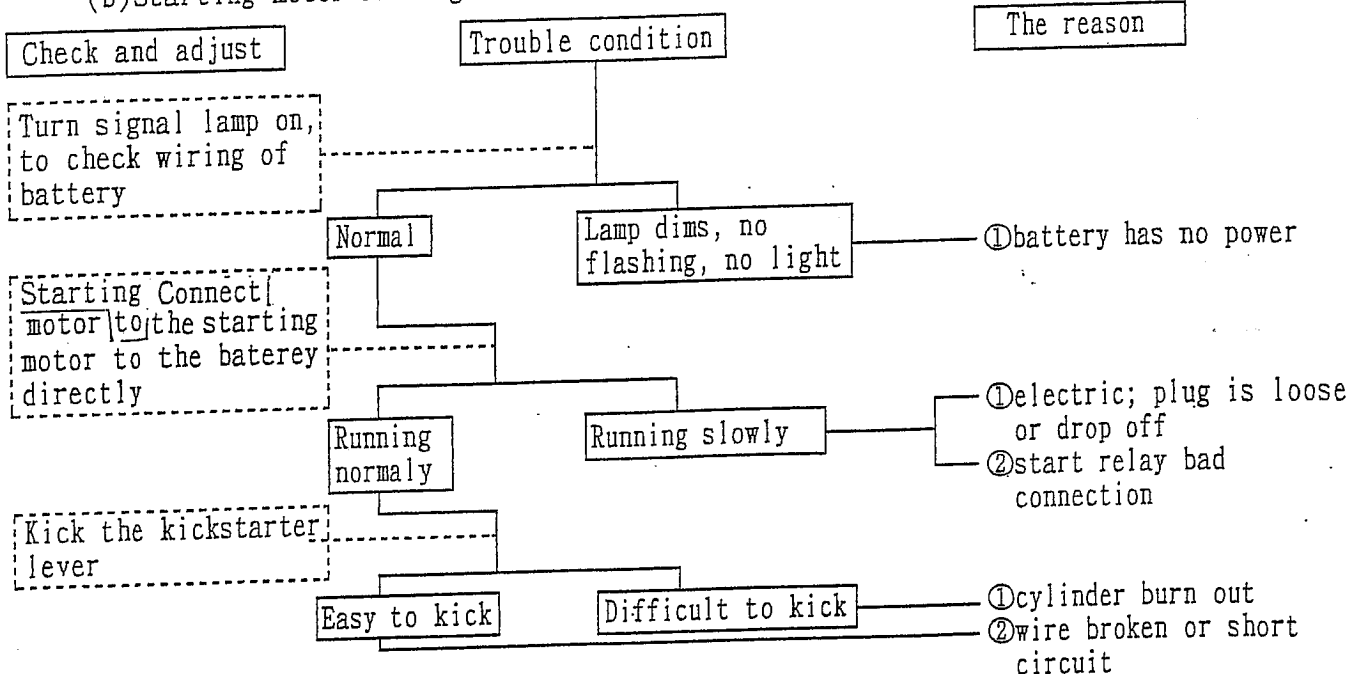

## (c) Starting motor can not stop after starting

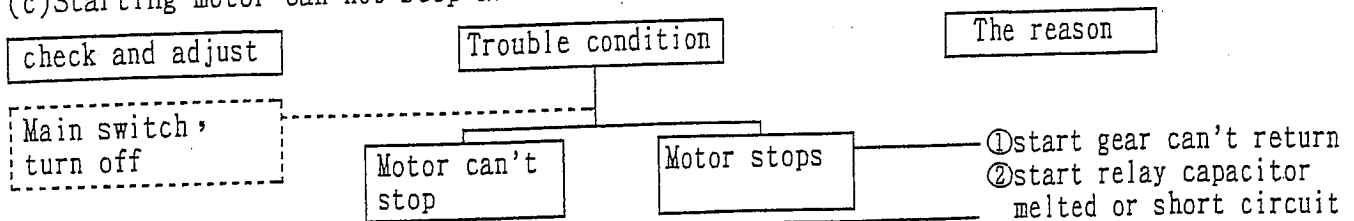



1 2.No sparking

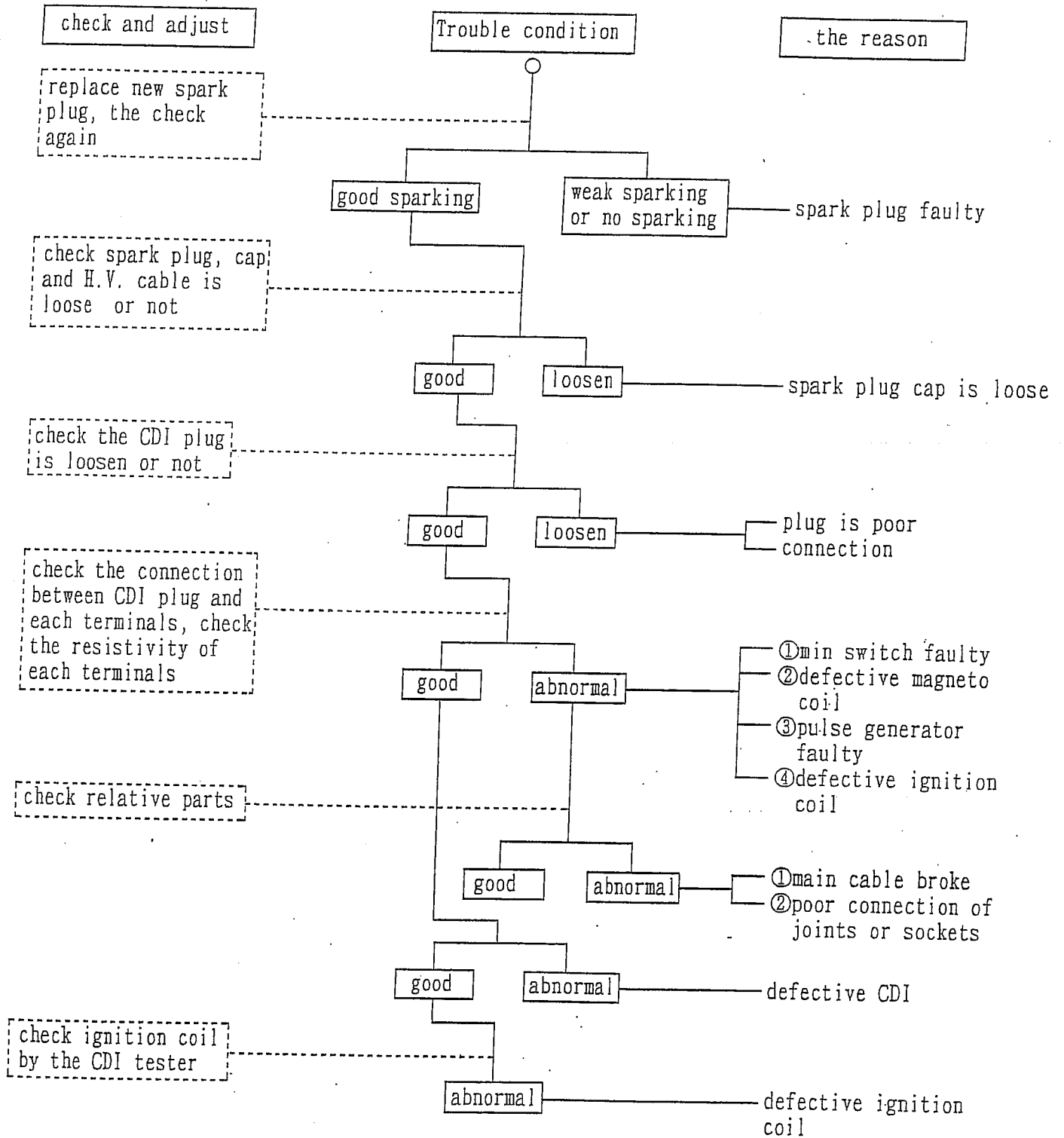

13. Charging abnormal (battery over charging or over discharging)

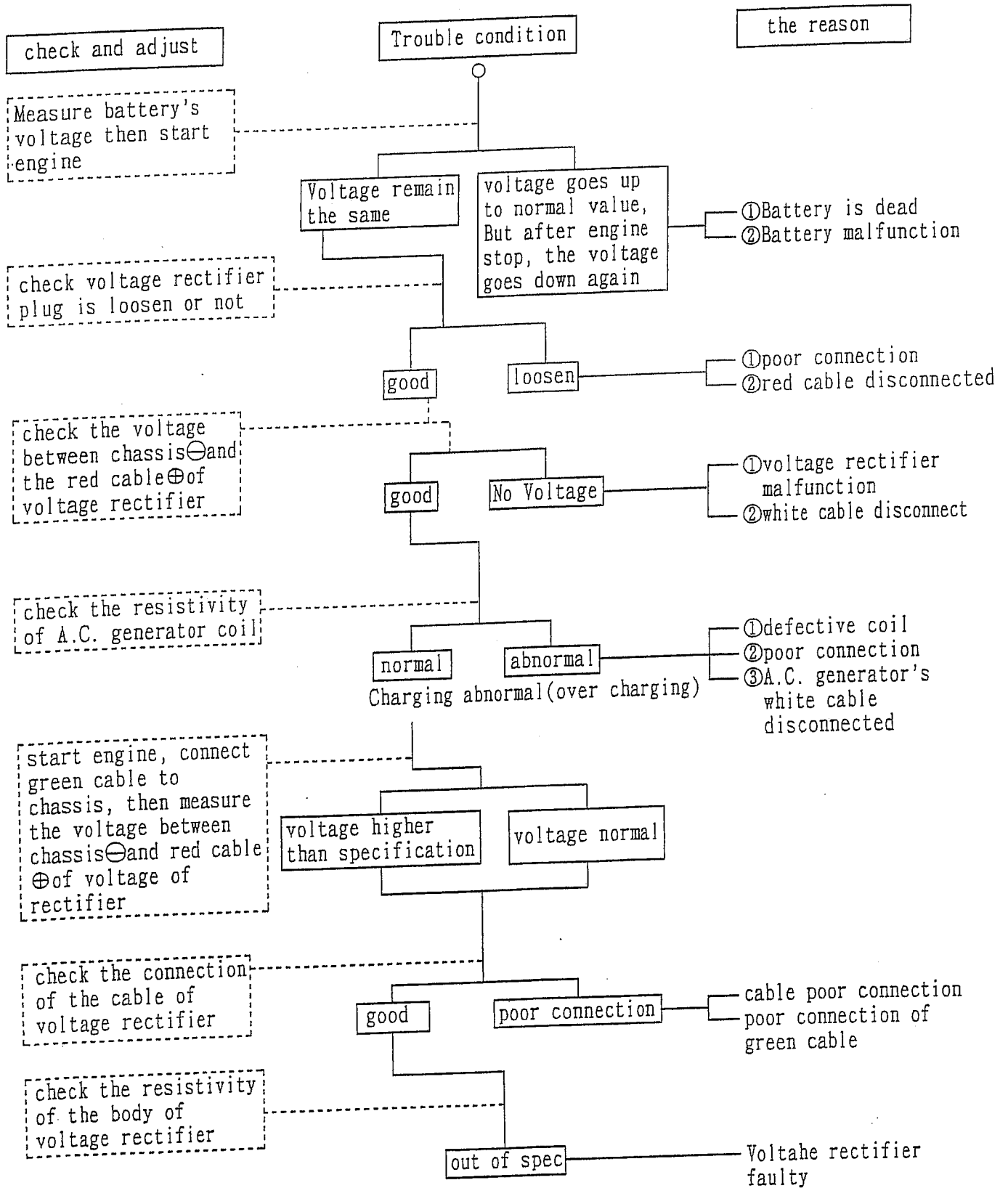

### III. Checking and Adjustment:

(1)Regular checking table .....	26
(2)Battery .....	26
(3)Clean air cleaner .....	26
(4)The final reduction mechanism oil .....	32
(5)Spark plug .....	32
(6)Compression pressure measurement .....	33
(7)Ignition timing .....	34
(8)Throttle cables adjustment .....	34
(9)Idle adjustment .....	35
(10)Front brake adjustment .....	35
(11)Rear brake adjustment .....	36
(12)Tire .....	36

(1) Regular checking table:

1.[○] mark indicates periodical checking

2.[※] indicates changing the parts

Item		Checking period							Judgement standard	Remark	
		general checking	first month or initial 500km	home		office					
				every 6 months or 5000km	every 12 months or 10000km	every 1 months or 1000km	every 1 months or 2500km	every 2 months or 10000km			
Suspension	Handlebar steering column	loose or swing	○		○	○	○	○	○		
		Operation	○		○	○	○	○	○		
		turning angle				○			○		
	Front fork	damaged			○	○	○	○	○		
		shaft fixed condition			○	○	○	○	○		check from steering column
		shaft: loose				○	○		○		check from steering column
Brake	Lever	a. clearance	○		○	○	○	○	○	clearance: front: 10-20mm rear :	
		b. movement of brake	○	○	○	○	○	○	○		
	Brake cable	loose or damage		○	○	○	○	○	○		
		change brake cable								※every 2 ears	
	Brake cam	worn out							○		
	Wheel hub and brake shor	a. clearance between hub and lining			○	○	○	○	○		
		b. brake shoe and brake lining worn-out				○			○	○	
c. wheel hub worn and damaged					○			○	standard dia: rear: 110.0mm limit of use: rear: 111.0mm		
Front wheel axle	damaged or distorsion							○			
Rear wheel axle	damaged or distorsion							○			
Wheel	Tire	pressure	○	○	○	○	○	○	○	unit: kg/cm <sup>2</sup> ; 1 driver front tire rear tire 2.0 2.0	
		cracked or damaged	○		○	○	○	○	○		
		tire thread worn out	○		○	○	○	○	○	Change tire according to Δ mark	
		tire surface or other intruders	○		○	○	○	○	○		
	Axle	Tighten the bolt and nut			○	○	○	○	○	front axle nut torque 5.0-6.0kg-m rear axle nut torque 11.0-13.0kg-m	Nut location
Rim	Swingness and damage condition			○	○	○	○	○	swingness Limit Vertical: below 2.0mm Horizontal: below 2.0mm		

Item			Checking period						Judgement standard	Remark		
			general checking	first month or initial 500km	home		office					
					every 6 months or 5000km	every 12 months or 10000km	every 1 months or 1000km	every 3 months or 2500km			every 12 months or 10000km	
Wheel	Bearing	Clearance on front axle		○	○	○	○	○	○			
		Clearance on rear axle			○					○		
Rear Damper	Spring	Damage condition	○		○	○	○	○	○			
	Ass'y part	loose or damaged condition			○	○	○	○	○			
	connecting part	loose or				○			○			
	Bracket	loose or damaged condition				○			○			
	Suspension arm	Looseness on connecting part				○			○			
	Absorber	Oil leakage				○		○	○			
		Damaged condition				○		○	○			
		Loose on ass'y part				○		○	○			
Transmission	Clutch and shift mechanism	Function			○	○	○	○	○			
		Gear oil leakage			○	○	○	○	○		LH crank case	
	Gear oil	Change gear oil			○	○	○	○	○		90c.c./Gearbox 220c.c./Reverse	
Electric	Ignition	Spark plug			○	○	○	○	○	clearance: 0.6 ~ 0.7mm NGK: BP7HS OR SAME SPEC		
	Start mechanism	Starting motor gear				○		○	○			
	Wiring	Recharge function			○	○	○	○	○			
	Battery	Electrolyte level				○	○	○	○	○	level between "UPPER" and "LOWER"	
		Electrolyte gravity					○		○	○	when 20°C specific gravity: 1.270-1.290	
Wire circuit	looseness or damage on connection Plug			○	○	○	○	○				

Item		checking period							Judgement standard	Remark	
		general checking	first month or initial 500km	home		office					
				every 6 months or 5000km	every 12 months or 10000km	every 1 months or 1000km	every 3 months or 2500km	every 12 months or 10000km			
Engine Mechanism	Engine parts	performance, noise			○	○	○	○	○		
		low speed, acceleration			○	○	○	○	○	idling: 1900 ± 100rpm	
		exhaustion	○		○	○	○	○	○		check the color of exhausting air
		air cleaner			○	○	○	○	○		
		cylinder, cylinder head, inlet pipe, locking condition							○	locking torque cylinder head: (cold) 1.0-1.2kg/m inlet pipe: (cold) 1.0-1.2kg/m	
		compression pressure				○			○	using starting motor. 7kg/cm <sup>2</sup> -500rpm for 110cc 6kg/cm <sup>2</sup> -600rpm for 50cc	
	Lubrication system	oil leakage			○	○	○	○	○		
		oil quantity, dirty			○	○	○	○	○		
		oil quantity,	○								
		oil filter blocked				○		○	○		
	Fuel system	fuel quantity	○								
		fuel leakage			○	○	○	○	○		
		clean carburetor			○	○	○	○	○		
		carburetor's throttle and choke function			○	○	○	○	○		
		carburetor float height			○	○	○	○	○		
		carburetor adjustment			○	○	○	○	○		
		change fuel pipe								※every 4 years	

Item		checking period							Judgement standard	Remark
		gen-eral che-cking	first month or 500km	home		office				
				every6 months or 5000km	every12 months or 10000km	every1 months or 1000km	every3 months or 2500km	every12 months or 10000km		
Lamp system	function	<input type="checkbox"/>		<input type="checkbox"/>	<input type="checkbox"/>	<input type="checkbox"/>	<input type="checkbox"/>	<input type="checkbox"/>		
	dirty or broken	<input type="checkbox"/>		<input type="checkbox"/>	<input type="checkbox"/>	<input type="checkbox"/>	<input type="checkbox"/>	<input type="checkbox"/>		
Horn, signal lamp, reflector	function	<input type="checkbox"/>		<input type="checkbox"/>	<input type="checkbox"/>	<input type="checkbox"/>	<input type="checkbox"/>	<input type="checkbox"/>		
Lock	function			<input type="checkbox"/>	<input type="checkbox"/>	<input type="checkbox"/>	<input type="checkbox"/>	<input type="checkbox"/>		
Rear view mirror	dirty or broken	<input type="checkbox"/>		<input type="checkbox"/>	<input type="checkbox"/>	<input type="checkbox"/>	<input type="checkbox"/>	<input type="checkbox"/>		
License plate	dirty or damaged	<input type="checkbox"/>								
Dashboard	function	<input type="checkbox"/>		<input type="checkbox"/>	<input type="checkbox"/>	<input type="checkbox"/>	<input type="checkbox"/>	<input type="checkbox"/>		
Muffler silencer	Losseness or damage on ass'y part			<input type="checkbox"/>	<input type="checkbox"/>	<input type="checkbox"/>	<input type="checkbox"/>	<input type="checkbox"/>		
	function			<input type="checkbox"/>		<input type="checkbox"/>	<input type="checkbox"/>			
Chassis	loose or damaged			<input type="checkbox"/>		<input type="checkbox"/>	<input type="checkbox"/>			
The previous abnormal case	confirm it does not happen again	<input type="checkbox"/>								
Others	chassis lubrication			<input type="checkbox"/>	<input type="checkbox"/>	<input type="checkbox"/>	<input type="checkbox"/>	<input type="checkbox"/>		
	decarbonate on combustion room and muffler			<input type="checkbox"/>				<input type="checkbox"/>		

(2) Battery: Recharge when the power is out.

1. Remove the floor mat.
2. Screwing out the two screws on the battery cover. Remove the battery cover.
3. Remove the negative cable and then the positive cable, → take out the battery to recharge.
4. To re-assemble the battery, please follow the opposite procedure of disassembling after recharging.

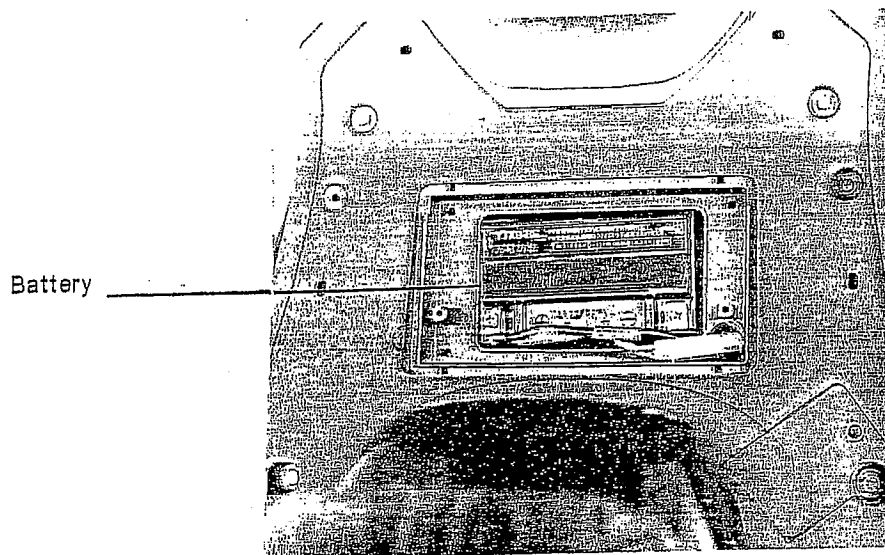
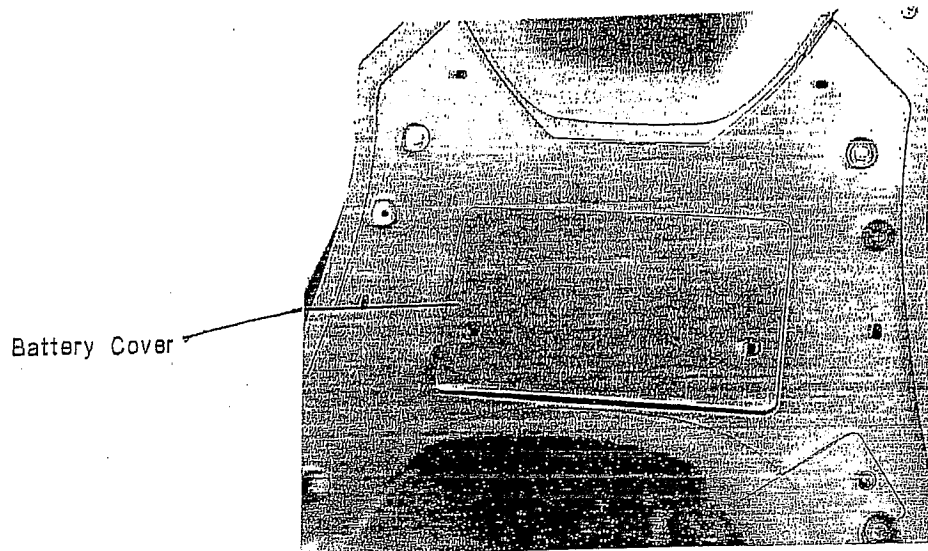

Note:

- A. The battery is totally sealed, do not remove seal bolts when recharging
  - B. It's no need to add any electrolyte for this re-filling free battery
- Please recharging(12V) by the following currency:

Standard recharging:  $0.4A \times 5-10$  hr or rapid recharging:  $4A \times 30$ min. (50c. c.)



### (3)Cleaning air cleaner

- 1.Remove air cleaner cover
- 2.Take out the air cleaner filter

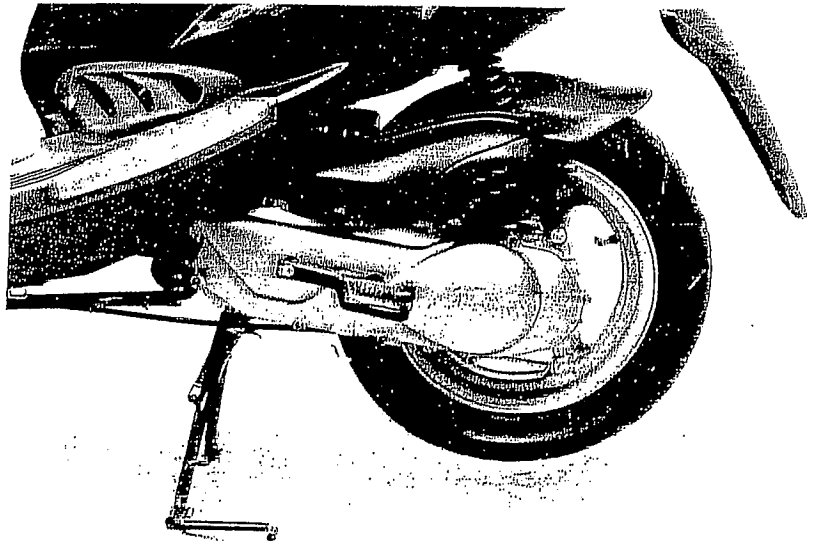

- 3.clean the filter by the compressor air.

- 4.Assemble the air cleaner by the opposite procedure.

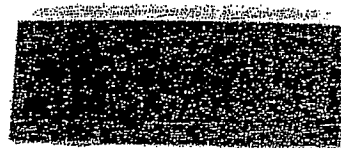
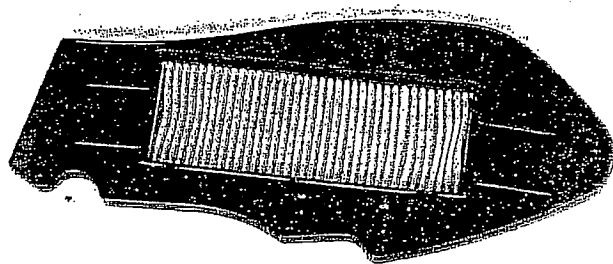

Note:Do not start the engine when the air cleaner is not installed

#### (4) The final reduction mechanism oil

1. Change the oil in the gear box:
  - a. Turn off the engine after warm up.
  - b. Put a bowl under the engine.
  - c. Remove the draining bolt and filter bolt to drain the gear oil off.
  - d. Lock the draining bolt before refill 90c.c. gear oil and then lock the filling bolt.
  - e. Locking torque: 1.8kg-m

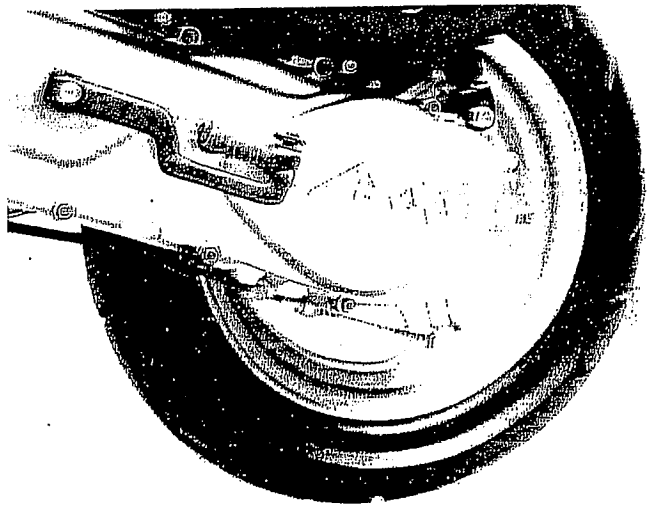

Note: Be sure the crankcase, tire or wheel are cleaned if there is grease/oil on it.

#### (5) Spark plug

1. Remove the spark plug
2. Check the spark plug electrode and check whether it is burnt out or not and carbonized or not
3. Clean the electrode, whether it is dirty
4. Spark plug specification:  
NGK: BP7HS or same spec.  
Gap of spark plug: 0.6~0.7mm

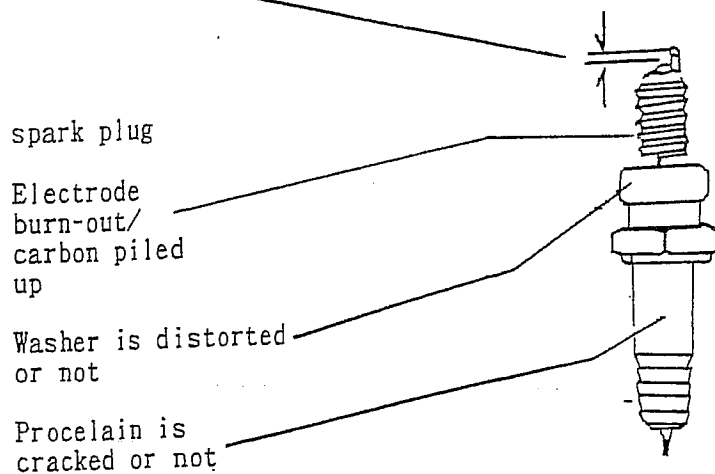

## (6) Compression pressure measurement:

1. Measure it when the engine is warm.
2. Remove the cover.
3. Remove spark plug then place compression pressure gauge.
4. Fully open the throttle, and kick to kickstarter 5 times continuously, Measure the compression pressure.
5. Compression pressure:  
50cc:6kg/cm<sup>2</sup>-600rpm.

6. When the compression pressure is too low, check the following:
  - a. cylinder head gasket cracked.
  - b. piston cylinder worn-out.
  - c. piston ring worn-out.
7. If The compression pressure is too high, it may be due to the carbon pile up on combustion chamber and piston tip.

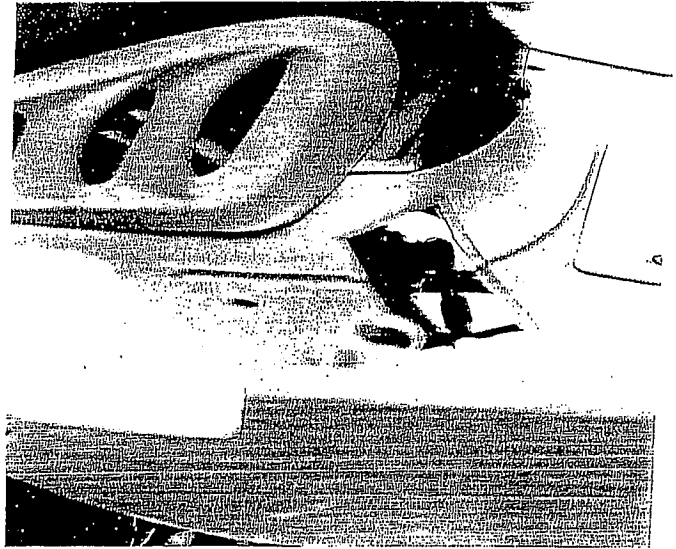

## (7) Ignition timing:

- This scooter is using CDI set, it is no need to adjust ignition timing.
- If ignition timing is not correct, check the CDI sets AC magneto, change it if it is abnormal.

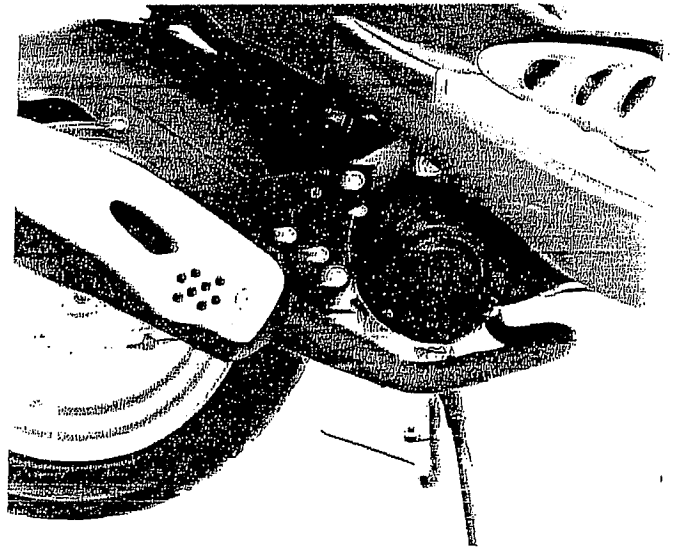

checking ignition timing:

1. Remove seat and luggage compartment.
2. Remove right body cover.
3. Remove the fan case.
4. Check with ignition timing lamp.  
Keep the engine running at  $1,900r \pm 100r.p.m$   
the checking mark should lay in  $\pm 3^\circ$  apart from "F", mark.
5. Ignition timing: B.T.D.C.  
 $17^\circ \pm 3^\circ / 1900rpm.$

## (8) Throttle cables adjustment:

1. Check the clearance of throttle
2. Normal clearance: 1.5-3.5mm
3. Adjust it by rotating the adjust nut. Change it if the throttle cables can't be adjusted

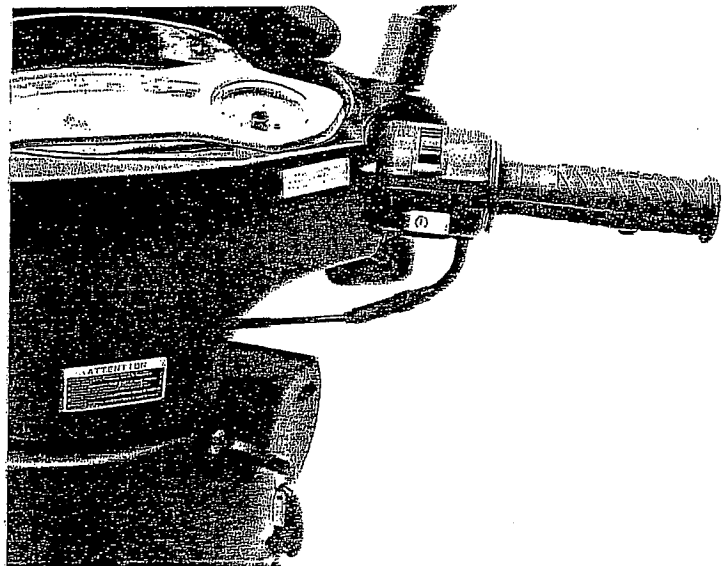

### (9) Idle adjustment:

Note: adjust it when the engine is warm.

1. Remove left body cover.
2. Start the engine and connect the tachometer.
3. Adjust the throttle valve screw to the specified revolution  $1900 \pm 100$  rpm.
4. If the idling rpm is still unsteady or fuel up is not smooth, please adjust it by followings.
  - a. Screw in the air adjust screw clockwise, then screw out counterclockwise.  
Recommended loop:  $1\frac{3}{8} \times \frac{1}{2}$
  - b. Rotate air adjust screw clockwise and counterclockwise to find out the highest revolution location.
  - c. Rotate the throttle valve screw to idling condition.
  - d. Fuel up gradually until the idling running rpm is steady.
  - e. If the rpm is still not steady please repeat above procedure.

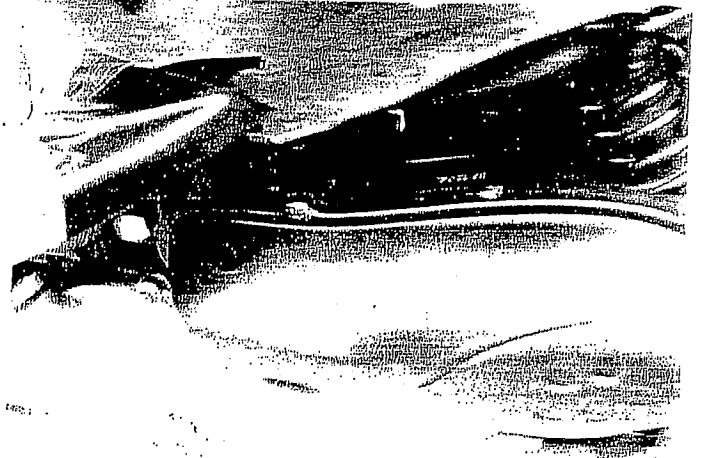

### (10) Front Brake Adjustment:

1. Check the clearance of front brake lever.  
clearance: 10-20mm
2. If the clearance is beyond, standard check whether:
  - a. The air mix into the pipe/caliper.
  - b. The oil brake system is leaking.

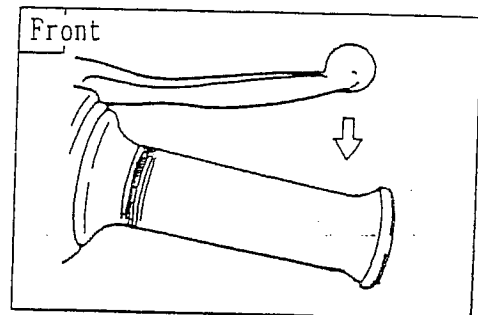

Note:

Try brake lever to see if it's loose. check the brake fluid. once air mixed in the fluid pipe, which will reduce or damage the brake efficiency or even its function.

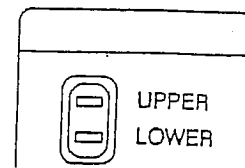

3. Check the fluid level:
  - a. Refill the brake fluid when the level is under the LOWER line.
  - b. Brake fluid specification: SAE J-1703F-DOT3 & DOT4.

Note:

- a. To prevent the fluid splitting onto the parts or clothes, put a piece of cloth on the bottom when refilling.
- b. Be caution not to mix water or particles into the master cylinder when refilling.
- c. Never use the fluid not complied with spec.
- d. In case the fluid stains on the eyes, wash with water at once and then ask for medical care immediately.

## (11)Rear Brake Adjustment

- 1.Check the clearance of rear brake lever.  
Clearance: 10-20mm
- 2.If the clearance is beyond the above standard,adjust it by rotating the screw.
  - a.Left-handed rotation-Enlarge the clearance.
  - b.Right-handed rotation-Reduce the clearance.

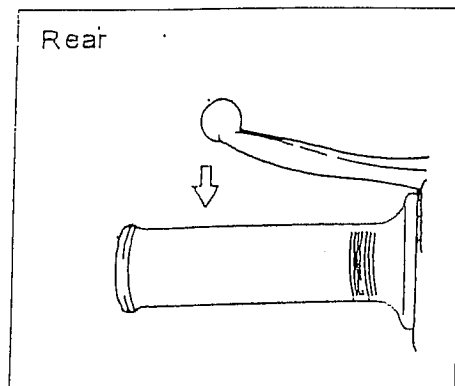

### Note:

When the arrow of rear brake indicator align with the arrow of left crankcase, change the brake lining.

## (12)Tire:

- 1.Check tire air pressure(when it's cold)
- 2.Tire pressure:  
Front tire:2.0kg/cm<sup>2</sup>  
Rront tire:2.0kg/cm<sup>2</sup>
- 3.Tire dimension:  
Front tire :120/70-12  
Rear tirel:130/70-12

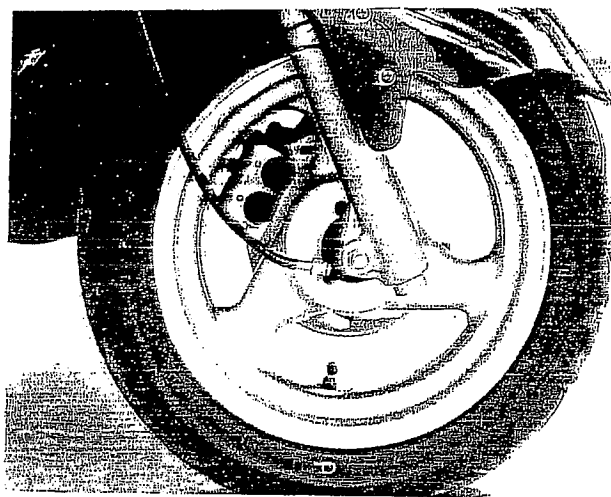

### Note:

- a.check and adjust the tire pressure when it is too low.  
The pressure is according to the carrier, driver, passenger, accessories and cruise speed.
- b.Proper loading is very important for steering, riding, braking,performance and safety.
- c.Never carry any parcel unfastened.
- d.Load the heaviest parcel on the center of vehicle, balancing the weight on both sides.
- e.Beware of the weight loaded properly and check the tire pressure. The total weight of carrier, driver, passenger, and accessories cannot exceed the approved limit. An overload vehicle is easy to cause tire damage and accident for rider.

- 4.Check is there any sharp object pierce the tire.
- 5.Check the depth of thread.  
· Depth(front & rear):  
According to mark of tire"▲" to change a new tire.

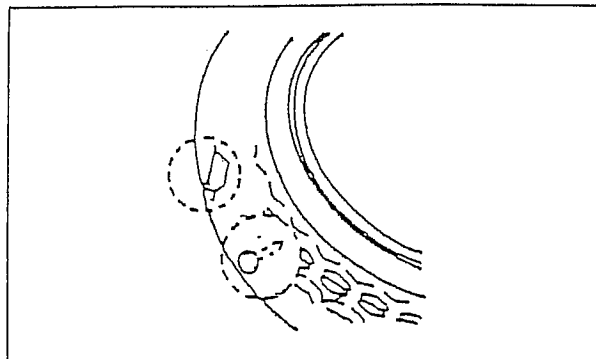

#### IV. Dismantling, Maintaining, Repairing and Assembling Operation:

(1) Lubrication system .....	38
(2) plastic parts .....	41
(3) Engine dismantling .....	46
(4) Drive pulley, starter, clutch .....	47
(5) Cylinder and, piston .....	56
(6) AC generator .....	65
(7) Final transmission mechanism .....	67
(8) Crankcase, crank shaft .....	71
(9) Carburetor, reed valve, and auto cock .....	78
(10) Steering bar, front wheel, front brake comp, front fork .....	83
(11) Rear wheel, rear brake, rear damper .....	92
(12) Fuel tank, oil tank .....	96

## (1) Lubrication system and oil pump

### 1. Lubrication system diagram.

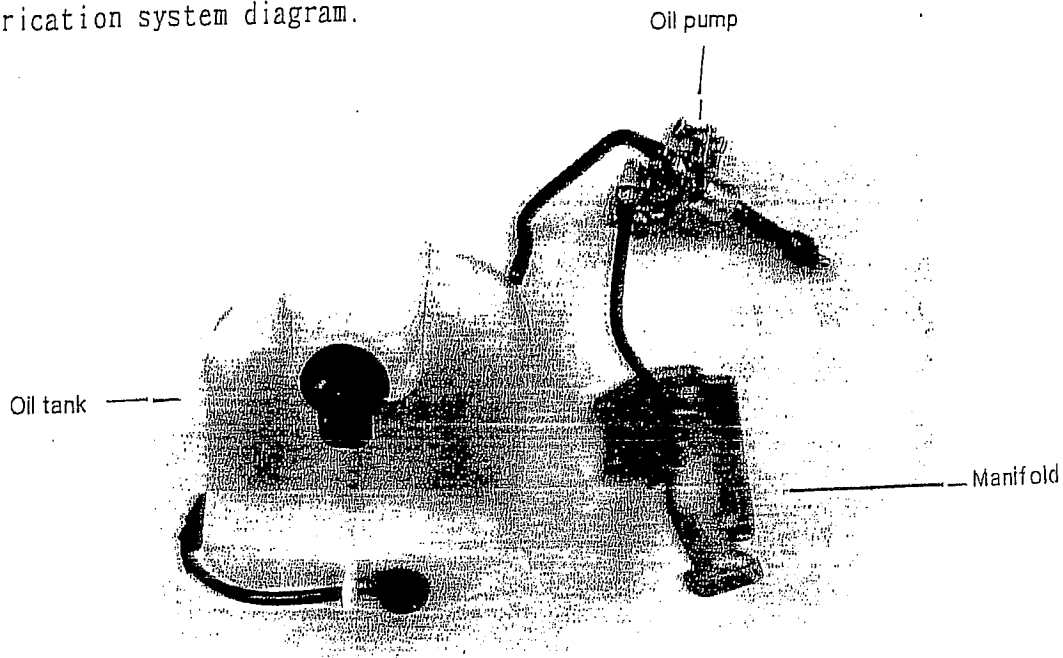

### 2. Trouble shooting.

A. If there is too much white fume from exhaust system, which means too much carbon piled up on the spark plug or the oil quality is not good.

B. Engine over heating:

- a. The adjustment of oil pump is not properly. (lack of oil)
- b. The quality of oil is not good.

C. Piston over burning.

- a. There is air in the oil pump system.
- b. Oil pump is out of order.

D. The route from oil tank to oil pump is blocked.

- a. Ventilation hole on the tank cover is blocked.

Note: 1. When removing oil pump, do not drop any unexpected objects into the oil pipe  
2. Please release the air if there is air trapped in the oil pipe.  
3. Locking torque of oil pump: 0.8-1.2kg-m



3. Remove the oil pump.

clean the oil pump and  
crank case before operation

- a. Remove the luggage.
- b. Remove the input/output oil pipe.
- c. Take out the oil pump by removing the locking screw on oil pump and oil gauge cable.

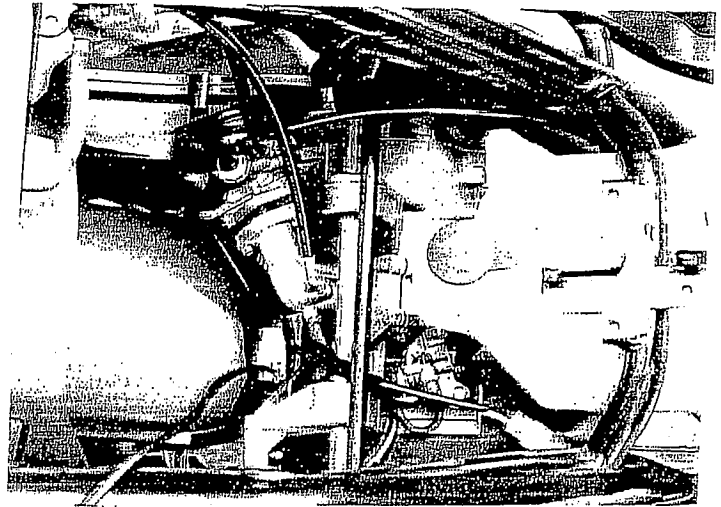

4. Check the oil pump.

Remove oil pump and check:

- a. O-ring is distorted or not.
- b. Contact area of crankcase is injured or not.
- c. Oil pump body is damaged or not.
- d. The movement of control lever is free or not.
- e. The gears are damaged or not.
- f. Check seal and see if there is oil leakage or not.
- g. Never dismantle oil pump, it can not function well after dismantling.

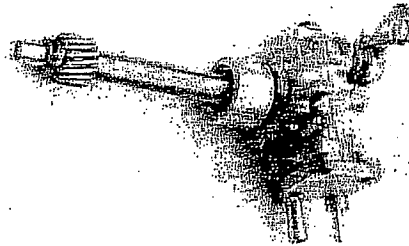

5. Assemble the oil pump.

- a. Assemble the oil pump by reversing above procedure.

- O-ring of oil pump should be lubricated by grease or oil, then place on crankcase.
- The contact surface of oil pump and crankcase should be assembled firmly.
- The gears of oil pump should be lubricated by grease.

- b. Be sure oil pump screw is tightened.

After assembling, check the following:

- a. The adjustment of control cables.
- b. Is there air in oil pipe.
- c. Oil leakage at any location.

6. Releasing air in the oil pump.

- If there is air in the oil pipe, it will cause engine lubrication trouble
- Releasing air operation means the release of air trapped in the air pipe and oil pump. Please firstly release air from the oil pipe.

- a. Fill up specific amount of oil to the oil tank.
- b. Place dry cloth under the oil pump.
- c. Remove the oil pipe.
- d. Use injector to fill up the oil in the oil pipe and oil pump body. Be sure the oil pipe and oil pump are full of oil before assembling.
- e. After assembling check if there is still air trapped in the oil pipe.

## (2) Plastic parts

1. Dismantling of luggage compartment.
  - Open the seat.
  - Take off the 4 bolts on luggage compartment.
  - Remove the luggage compartment.

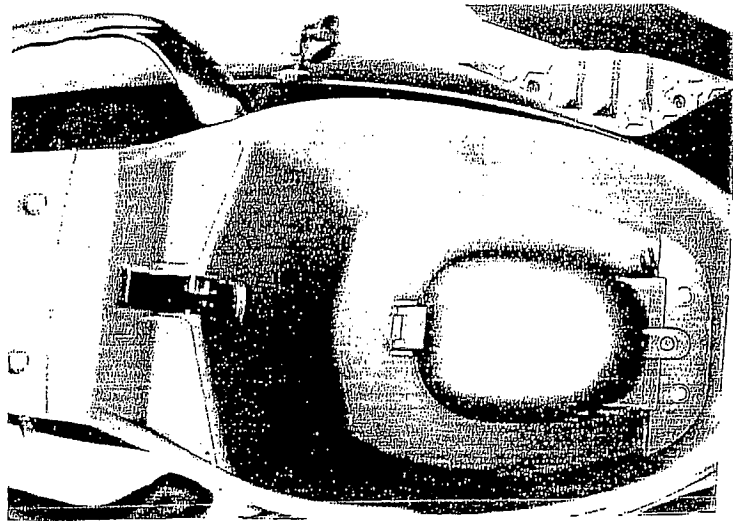

2. Take off the fixing screws (altogether 6) of the left and right handrails.
  - Remove the left/right handrails.

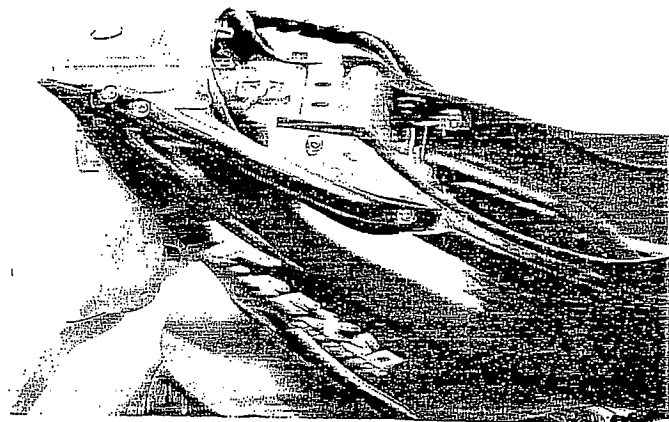

3. Remove the nine screws of the left/right body covers and the two screws of the seat lock.

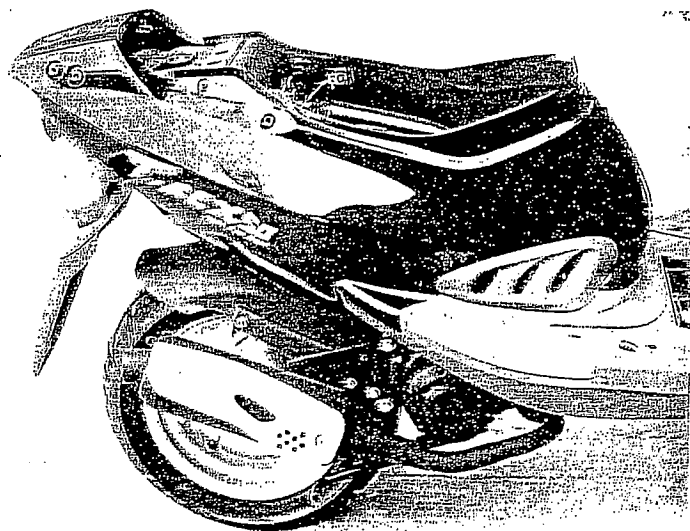

4. Take off the tank cover and left/right body cover.

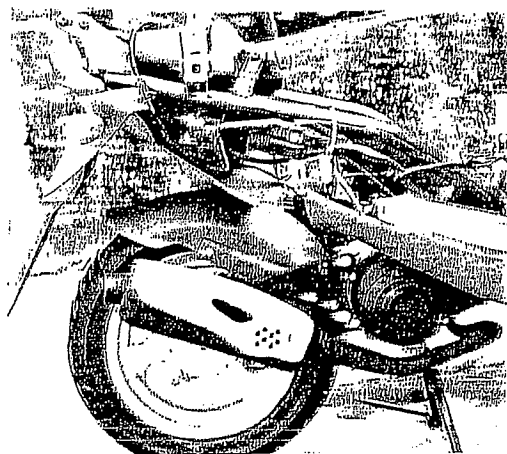

5. Take off the eight screws of the 4 screws on the slip proof plate.  
· Remove the step floor.

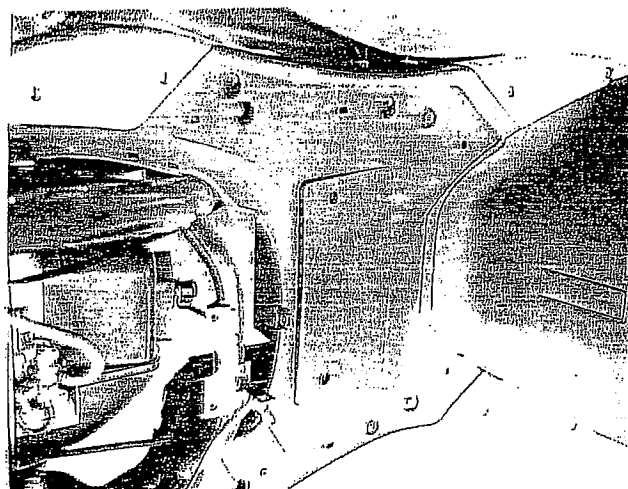

6. Remove the two screws of the battery cover firts, then the battery cables.  
· Remove the negative battery cable firts, then the positive one.

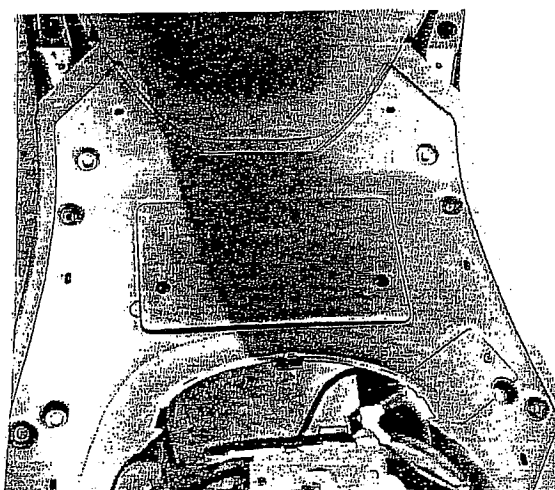

7. Take out the battery.

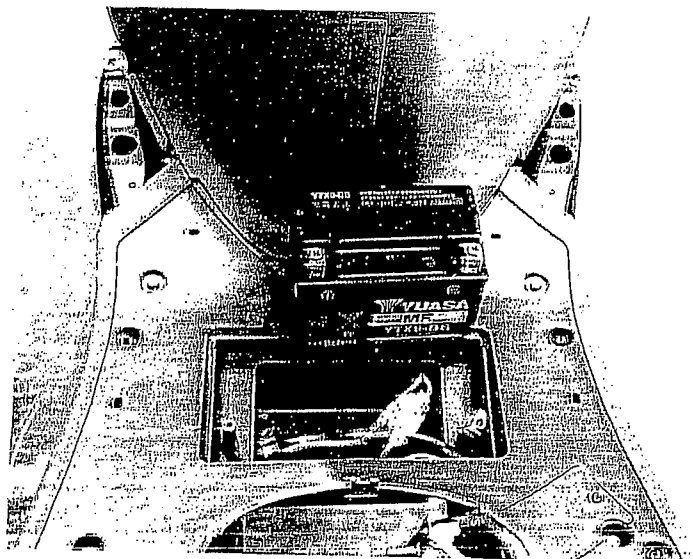

8. Take off the step floor and four fixing screws on the frame.  
· Remove the two screws on the left and right lower mudguard.

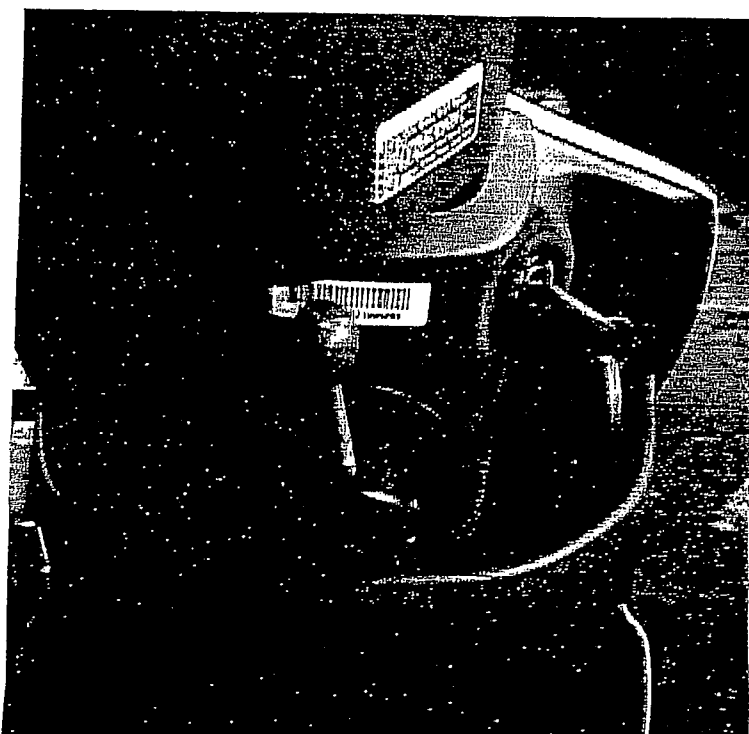

9. Dismantling of the windshield.

- a. Take off the screw on the step floor.
- b. Take off the self-tapping screws on the front lower mudguard.
- c. Take off the six fixing screws on the front inner cover.

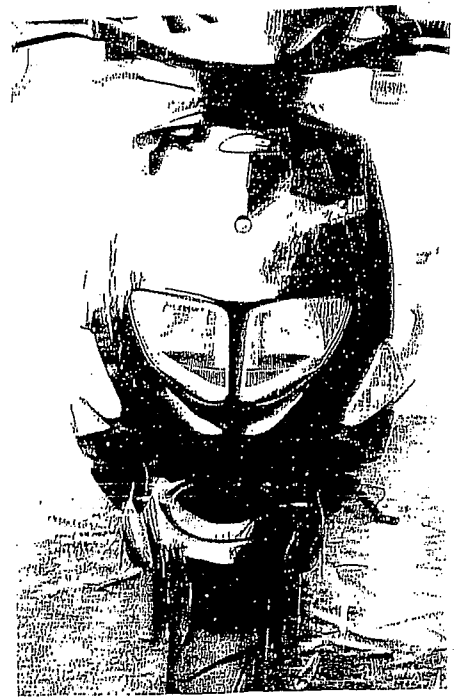

10. Remove the cables of the head lamp and signal lamp.
- Take off the windshield.

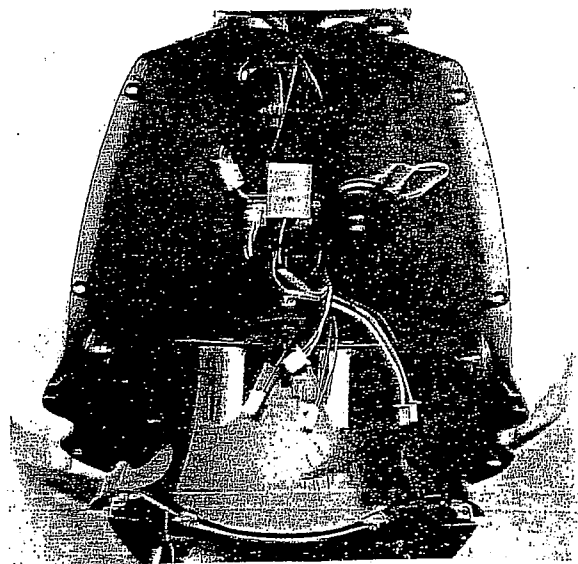

11. Take off the fixing screw on the front mudguard and the frame.

• Take off the front mudguard.



12. Take off the screw on the front inner cover and the frame.

• Take off also the two screws of the luggage hook.

• Remove the hook and the front inner cover.

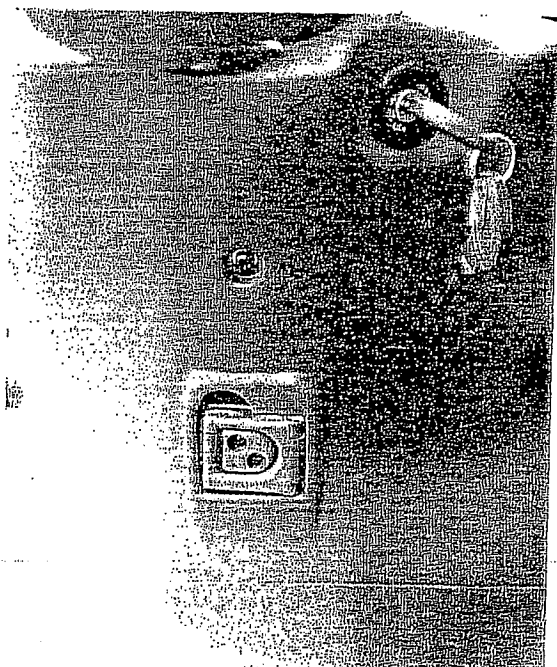

### (3) Engine Dismantling

#### A. Dismantling engine.

1. Take off the luggage compartment.
2. Take off the left and right booy covers.
3. Take off the lower mudguard fender.

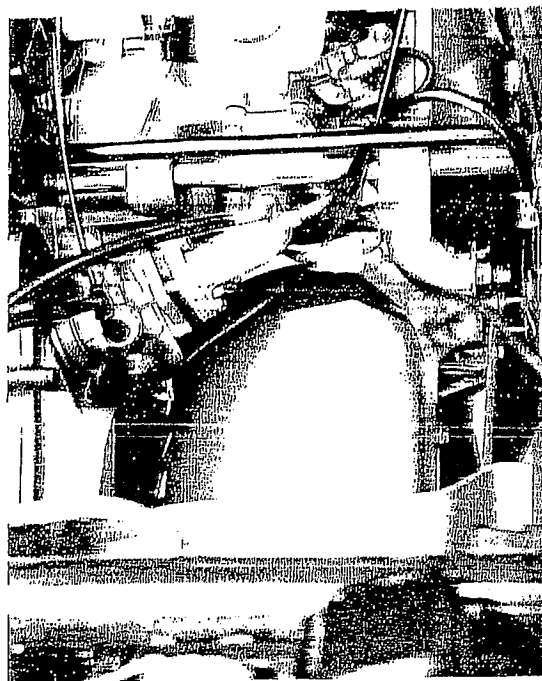

4. Remove vacuum pipe, fuel pipe, auto Choke, cap of spark plug, rear brake cable carburetor pipe, engine flywheel shelf's nut, starter motor cable plate and rear damper bolt.

5. Remove the engine.

#### B. Installing Engine.

1. To install engine, please reverse the above procedures.
2. Locking torque:  
M8: 2.0~3.0kg-m  
M10: 3.0~4.0kg-m  
M12: 5.0~6.0kg-m
3. After installing, please do the following checking and adjustment:
  - a. Wiring connection.
  - b. Throttle cable and oil control cable.
  - c. Rear brake adjustment.
  - d. fuel and oil route.

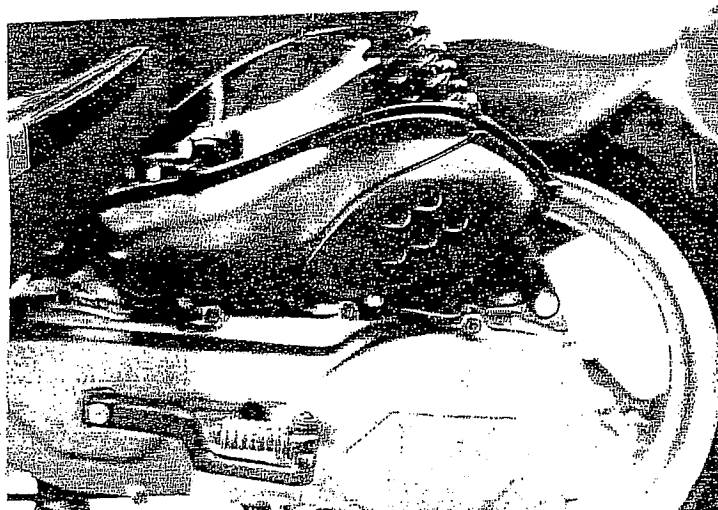



#### (4) Drive pulley, starter & clutch

##### A. Troubleshooting:

- a. Engine starts, but vehicle does not move.
  1. driving belt worn out
  2. driven plate worn out
  3. clutch lining worn out
  4. driving plate's spring broken
- b. The vehicle stops or trembles when running.
  1. clutch lining spring cracked or broken.
- c. Can't reach high speed, no pick-up
  1. driving belt worn out.
  2. driving plate spring distortion.
  3. Weight roller worn out.
  4. driving plate abnormal.

Note:

No grease and oil allowed to stain on driving belt and driving plate.

##### B. CVT parts measurement data:

Item	Standard value ( mm )	Limit of use ( mm )
Model	50CC	50CC
The inner dia. Of slide driving plate	20.035~20.085	20.123
The outer dia. Of boss, movable Driving plate	19.960~19.974	19.911
Belt width	18.0~19.0	17.0
Clutch lining thickness	3	1.5
Clutch outer diameter	117.0~117.2	117.5
Driven plate spring, free length	87.9	82.5
The outer diameter of driven Plate sets	33.965~34.025	33.95
The inner diameter of slide Driven plate	34.000~34.025	34.070
The outer diameter of weight Roller set	15.992~16.008	15.50

### C. Driving Pulley.

1. Take off the 10 screws of left cover, Remove the left cover.

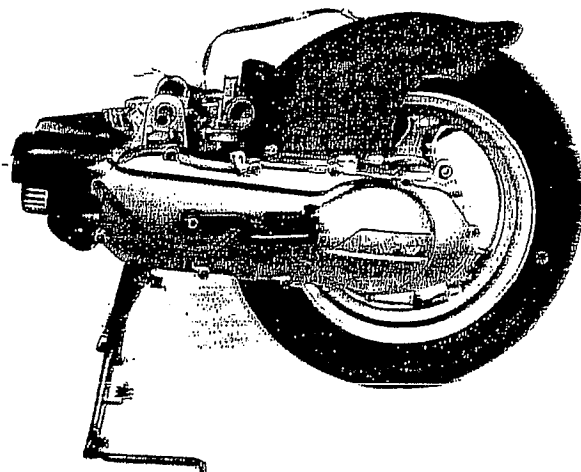

2. Take off the left cover.

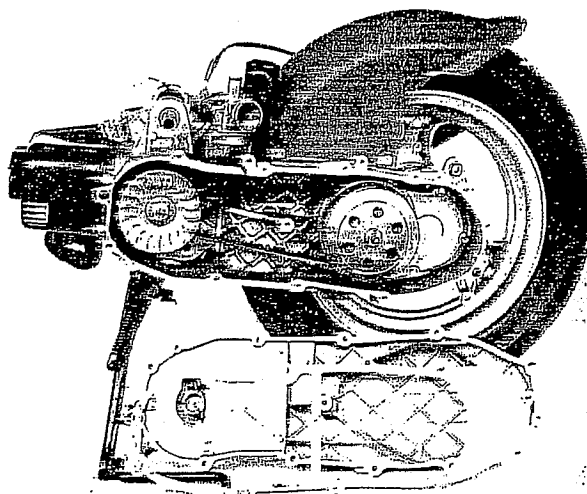

3. Remove the fixing nut of the clutch.

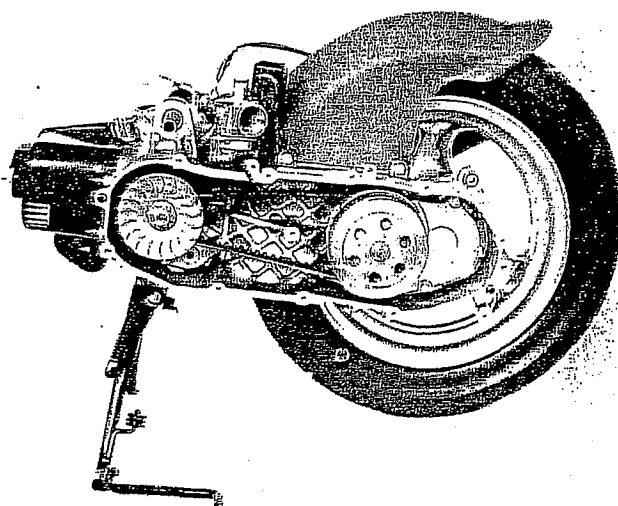

4. Take off the ramp plate.

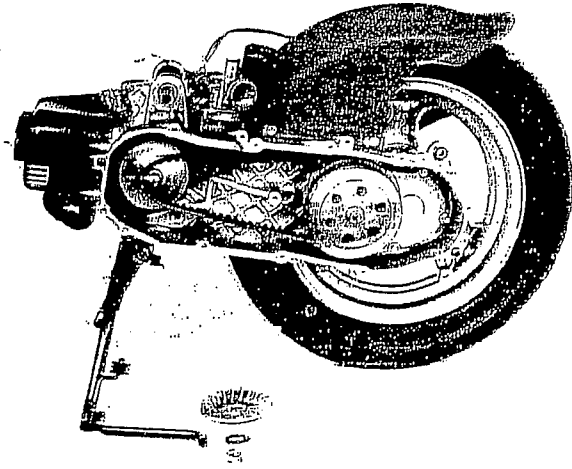

5. Take off the belt and the rear clutch.

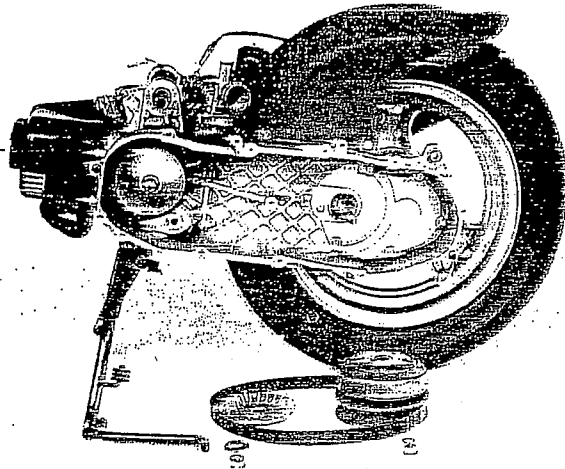

6. Take off the driving plate.  
• Take off the driving gear start set.

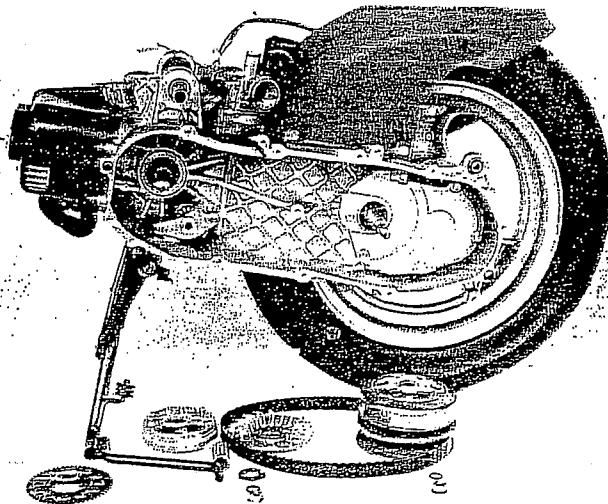

7. Remove the start idle gear fixing plate.

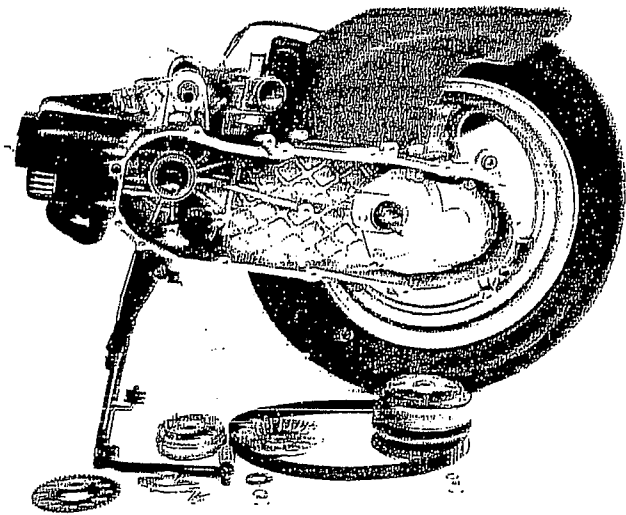

8. Take off the idle gear.

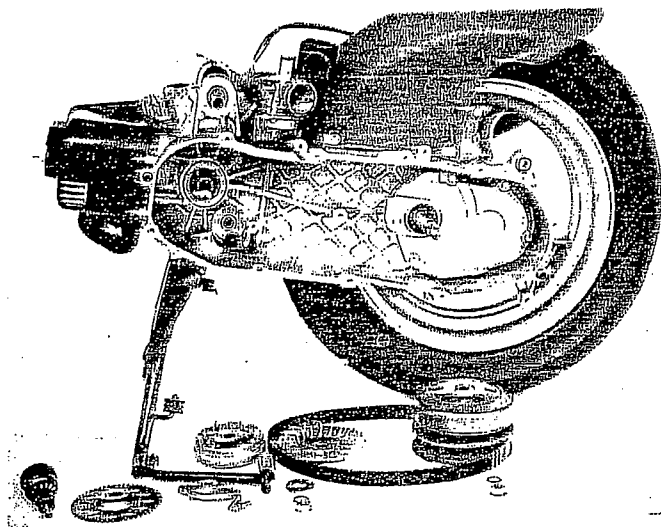

9.To assemble the driving pulley, please reverse above procedures.

Locking torque:

- 1.Nut of driving pulley:M10:3.2~4.0kg-m
- 2.Locking nut of clutch:M10:3.5~4.0kg-m

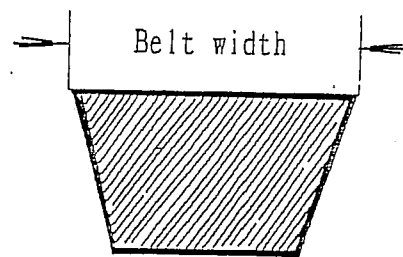

10.Checking the driving belt

- (1)Check whether it is cracked or not or its rubber and fiber are loose or not.  
Check also if they are extraordinarily worn out.

(2)Driving belt width:

limit of use:change it below 17.0mm.

11.Disassemble the slide driving plate set

- (1)Remove the bush of the slide driving plate.
- (2)Remove the screw, and disassemble the cover of slide driving plate.
- (3)Remove RAMP plate.
- (4)Remove weight roller.

12.Checking list:

- (1)Check the wearing condition of the weight roller.

limit of use:change it when below 15.5mm.

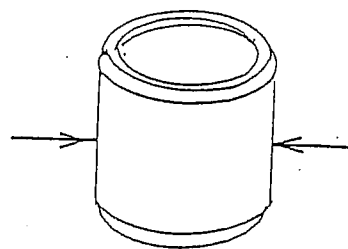

Checking the wearing condition

(2) Check inner dia of slide driving plate gasket.

Limit of use:

50cc: Change it when above 20.123mm

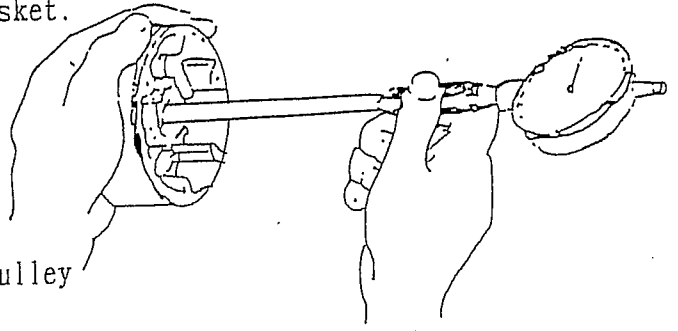

(3) Check the wearing condition for driving pulley surface.

(4) Check the outer diameter of the driving plate's boss.

Limit of use:

50cc: Change it when below 19.911mm

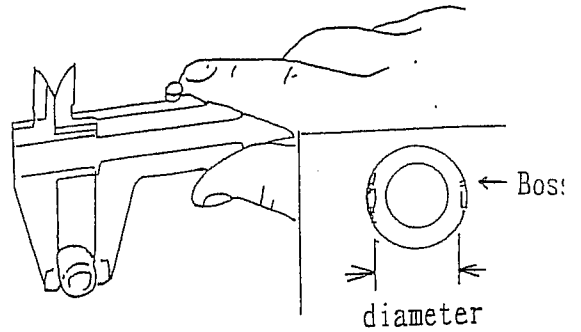

13. Assemble the slide driving plate.

(1) Clean the inner surface of the slide driving plate, then assemble the roller.

(2) Assemble the ramp plate.

(3) Please reverse the procedures of dismantling of finish assembling.

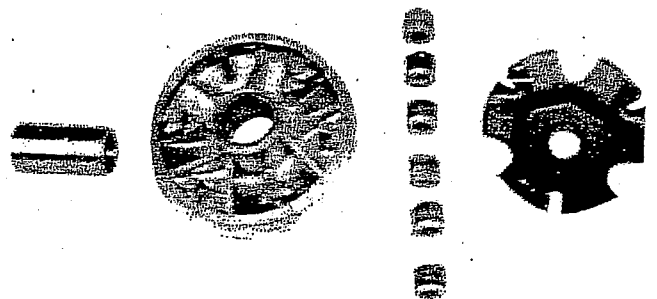

#### D. Starter dismantling.

1. Dismantle the left crankcase cover.
2. Remove the hexagon nut, then remove the starter lever.
3. Remove five screws of isolating plate.
4. Remove the stater spring from the start returning positioner.
5. Remove the driven gear comp of kick starter.
6. Remove the retaining c-type clip.
7. Remove the spindle comp. of kick starter.
8. Checking the starter
  - a. Check the wearing condition of the outer diameter of the spindle comp and the inner diamter of bush and gear.
  - b. Check the wearing condition of the shaft of driven gear comp, gear sets and ratchet.
9. Assembling the starter

To assemble the starter, please follow the opposite procedures of dismantling.  
Locking torque: M6: 1.0~1.2kg-m

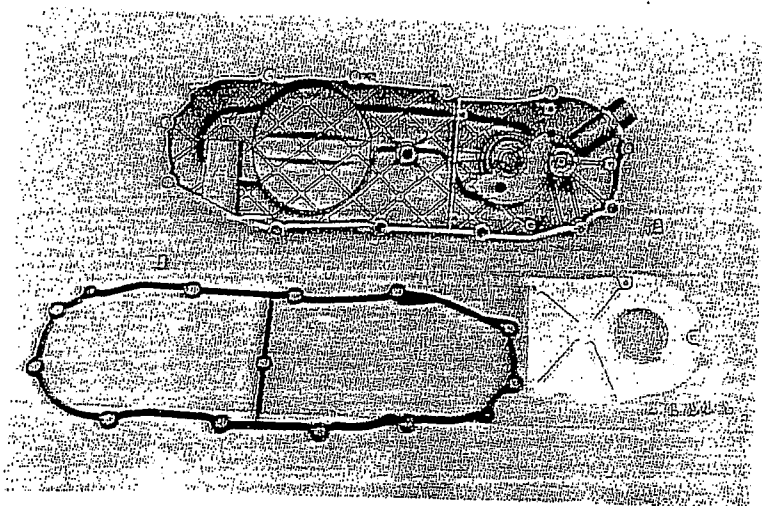

#### Note:

- ① Make sure that one end of the torsion spring is hooked on the groove of driven gear, and another end of the torsion spring is hooked on the pole inside the left crankcase.
- ② Put some grease on shafts and gear sets before assembling

## E. Clutch driven pulley

1. Dismantle the clutch
  - a. Remove left crankcase cover.
  - b. Remove driving plate.
  - c. Remove driving belt.  
Remove the M10 locking nut, then the clutch.
2. Assembling the clutch: please follow the opposite procedures of dismantling.

Locking torque:  
M10: 3.5~4.0kg-m

### 3. Checking the clutch:

Dismantling the clutch needs the special tool. Please contact your dealers.

- a. Check the clutch driving face.  
Check the clutch cover about its wearing condition and inner diameter measurement.

Limit of use:  
50c.c: Change it when above 117.5mm

- b. Check the clutch lining wearing condition and measure the lining thickness  
· limit of use: change it below 2.5mm.

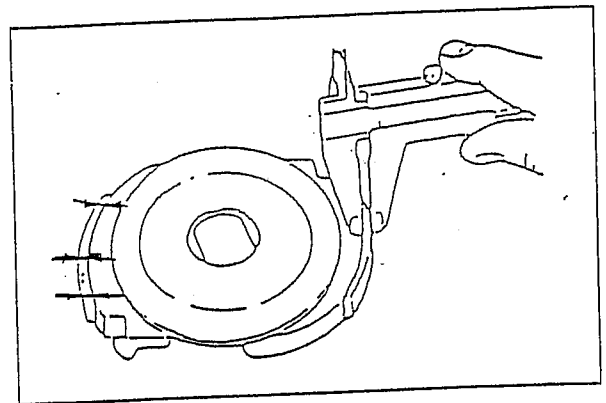
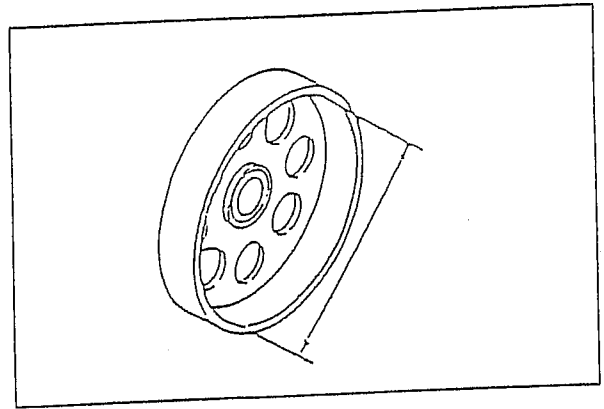



c. Check driven spring free  
length: standard: 87.9mm (50cc)

Limit of use: change it as it  
is below 82.5mm (50cc)

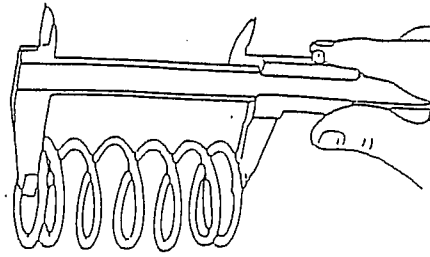

d. Check wearing condition of  
driving plate set.  
outer diameter measurement:  
limit of use: change it as it  
is above 33.950mm

e. Check wearing condition of  
slide driven plate  
Inner diameter measurement:  
Limit of use: change it as  
it is above 34.070

f. Check is there any wearing  
occur to the ditch.

g. Check wearing condition of  
seal location, if necessary  
change a new one.

(5) Cylinder and piston:

A. Troubleshooting.

a. compression pressure is too low, difficult to start engine and running unsmoothly.

1. Cylinder head gasket cracked.
2. Spark plug is not well-locked.
3. Piston ring worn out or cracked.
4. Cylinder, piston worn-out.
5. Reed valve is defective.

b. Compression pressure is too high, Engine overheating or abnormal noise.

1. piston tip has too much carbon piled up.

c. Abnormal piston noise

1. Cylinder and piston worn out.
2. Piston pin hole or piston pin worn out.
3. Connecting rod small-end or bearing worn out.

d. Abnormal piston or cylinder noise.

1. Piston ring worn out or cracked.
2. Cylinder worn out or cracked.

B. The operation notice:

1. Clean before operation to avoid particles dropping into the engine.
2. The contact surface of gasket must be clean.
3. Dismantle the cylinder and the cylinder head by screw driver.  
Do not scratch the contact surface.
4. Cylinder inner surface and piston outer surface cant be scratched.  
The contact surface should be lubricated by specified oil.

C. PISTON & CYLINDER DATAS:

Part name /description		Standard value (mm)	Limit of use (mm)
Cylinder head	flatness		0.100
Cylinder	Bore	39.995~40.015	40.050
Piston/ Piston ring	Clearance b/w Piston and Piston ring	1st ring	0.05~0.06
		2 <sup>nd</sup> ring	0.05~0.06
	Piston outer diameter	39.950~39.970	39.895
	Measuring location of piston outer dia. (12mm from the lower end of skirt)		
	Clearance b/w piston and cylinder	0.045~0.065	0.10
	Piston pin hole inner dia	13.022~13.013	13.045
	Piston pin hole inner diameter	10.002~10.008	10.025
	Piston pin outer diameter	9.994~10.000	9.970
	Clearance between piston and piston pin	0.004~0.018	0.030
	Connecting rod small end inner dia	13.996~14.007	14.025

D. Cylinder head, cylinder, and piston dismantling.

1. Remove the engine.

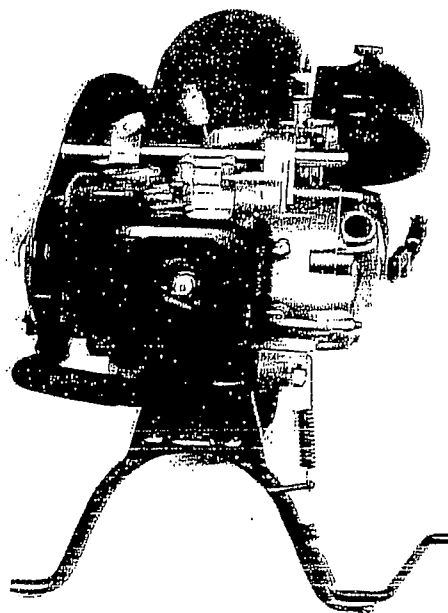

2. Screwing out the two  
M6-bolt of cooling cowl.

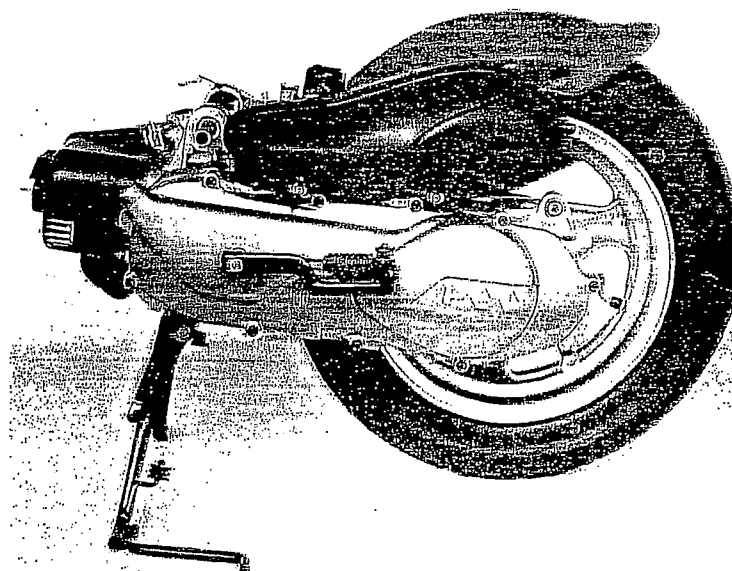

3. Screwing out the two M6-bolt of the fan cover.

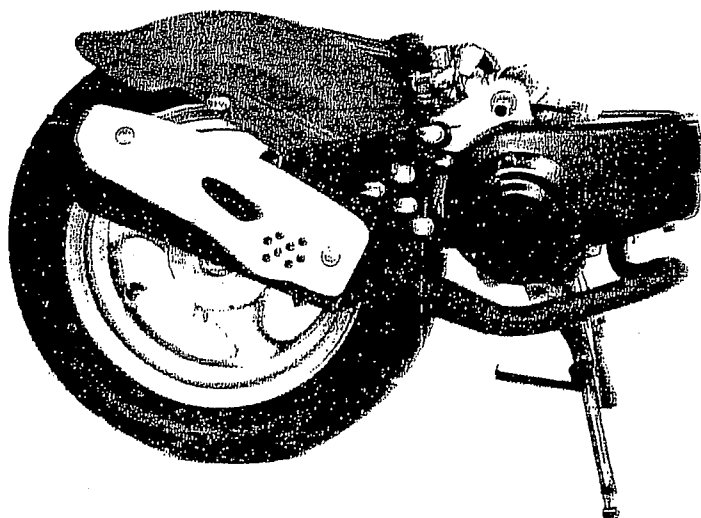

4. Remove the cooling cowl and fan cover.

5. Remove off the spark plug.

6. Remove the two M6 nuts on the muffler and the cylinder.

Also remove the two M8 bolts.

7. Remove muffler.

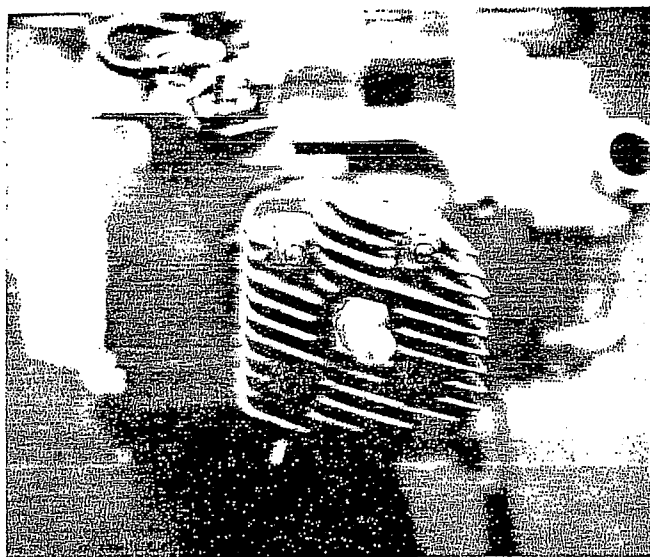

8. Remove the four M7-nut on the cylinder head, then remove the cylinder head and the cylinder head gasket.

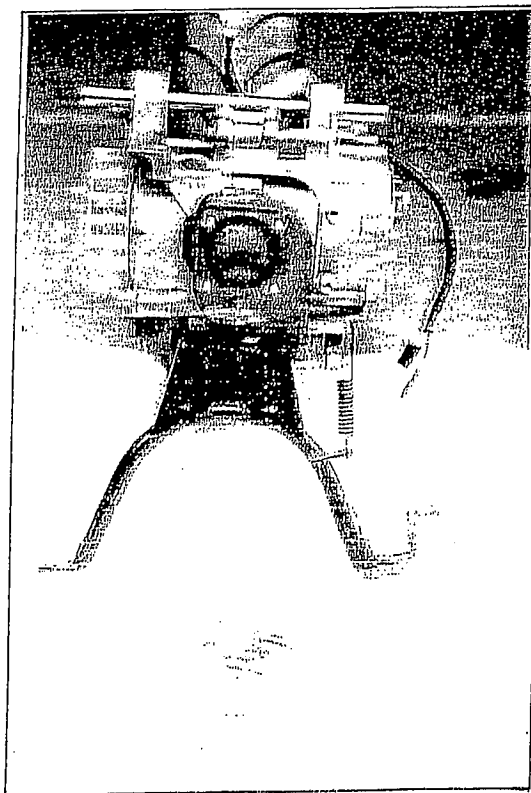

9. Remove the Cylinder and the gasket.

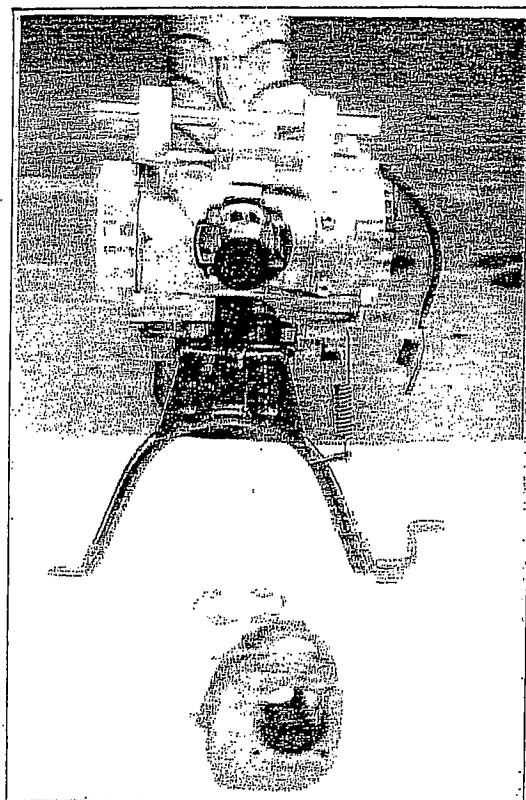

10. Remove the c-type clip on the piston and piston pins by the nipper.  
· Take off piston.

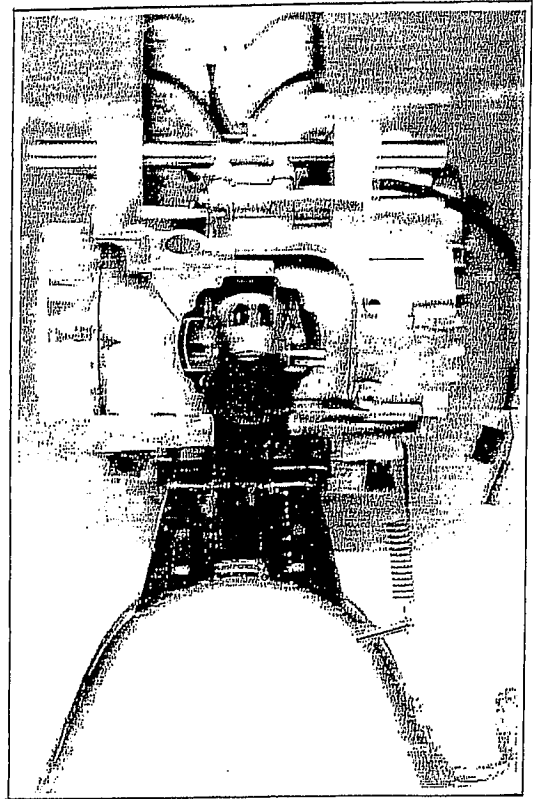

11. Dismantling of the piston ring Take off the first piston ring then the second ring.

12. When assembling please reverse the procedures of dismantling.

Locking torque:  
M7:1.0-1.4kg-m  
M6:1.0-1.2kg-m

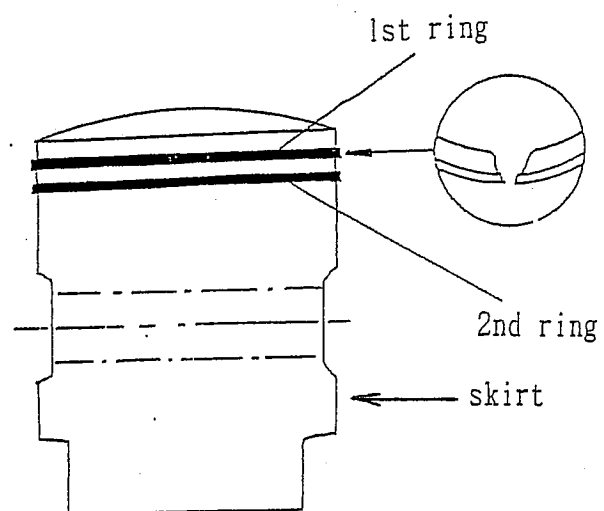

E. Check for the flatness of cylinder head.

- Check the flatness of contact surface of Cylinder head.

Limit of use: If it exceeds  
0.1mm, change a new one.

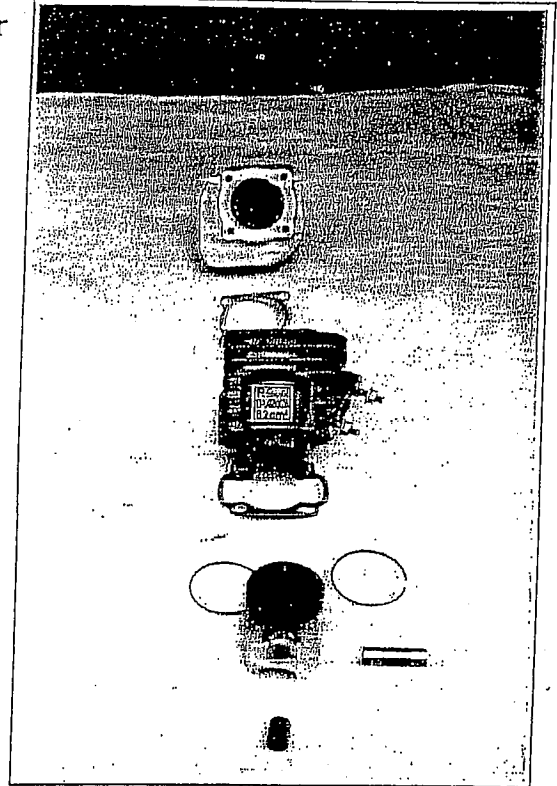

F. Combustion chamber cleaning

- Clean out the carbon piled up in combustion chamber.
- Do not scratch the combustion chamber and the contact surface of the cylinder during cleaning operation.

G. Check cylinder and piston:

1. Check the wearing and damage condition on the contact surface of the cylinder and piston.
2. Clean out the carbon on the cylinder exhausting port.

Be careful not to scratch the inner surface of cylinder.

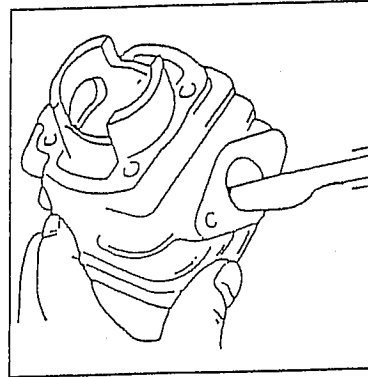

3. Cylinder bore measurement:

- (1) Measure each point (A)(B)(C) orderly, and in X.Y. axis to find the smallest value.
- (2) Limit of use:  
50cc-change it when over 40:050mm

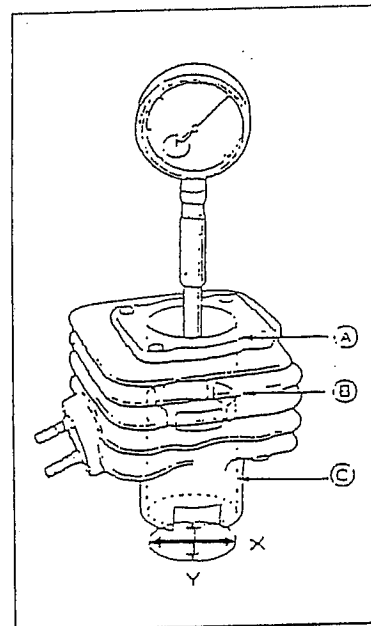

4. Piston outer diameter measurement:

- (1) Measure at the skirt area where is 12mm from the lower end of skirt.
- (2) Limit of use:  
50cc-change it when below 39.895mm
- (3) Calculate the clearance between the cylinder and piston.

Limit of use: change it when over 0.100mm

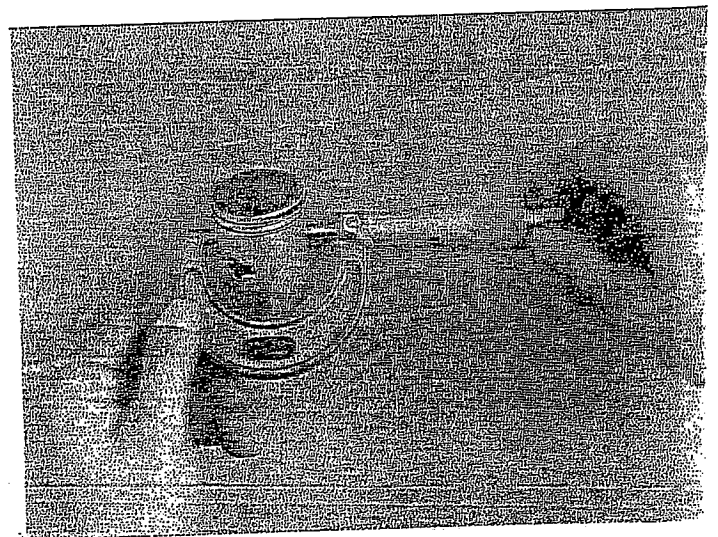



5. Inner diameter measurement of the piston pin hole  
Limit of use:chang it when over 14.032mm

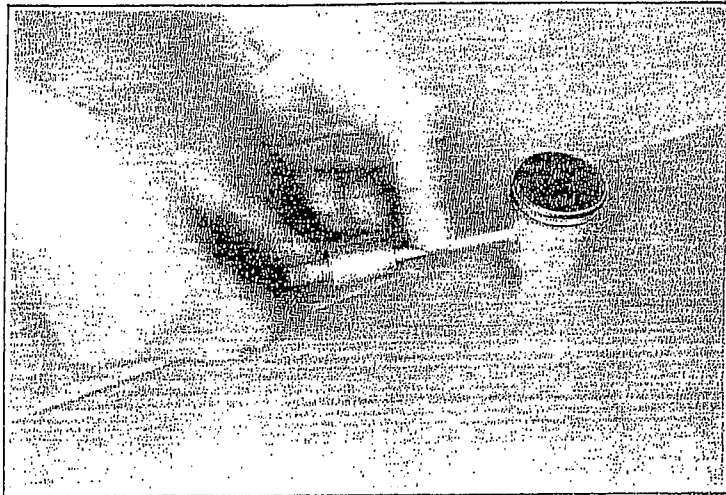

6. Outer diameter measurement of the piston pin  
limit of use:change it when under 9.970mm(T-REX 50)

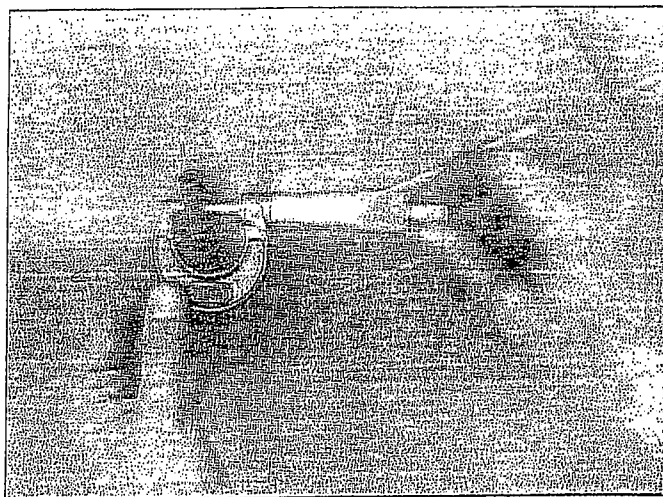

7. Check piston ring:

Measure piston ring gap:

Limit of use:change new ones  
when the first ring and second  
ring are over 0.4mm.

Push the piston ring into  
the cylinder by piston,  
the measure the gap.

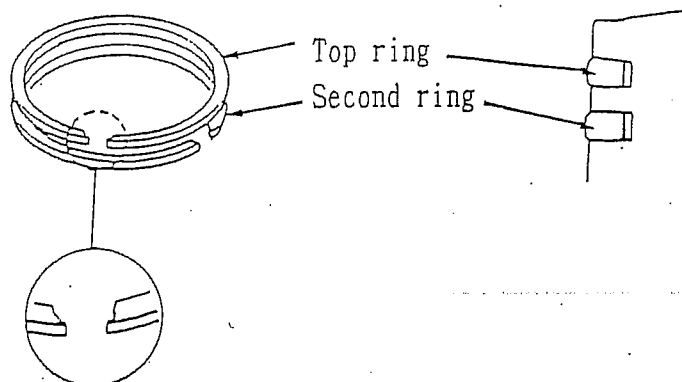

## 8. Check connecting rod small end

(1) Install piston pin, bearing onto the connecting rod small end, then check the looseness of the piston pin.

(2) Measure the inner diameter of the connection rod small end.

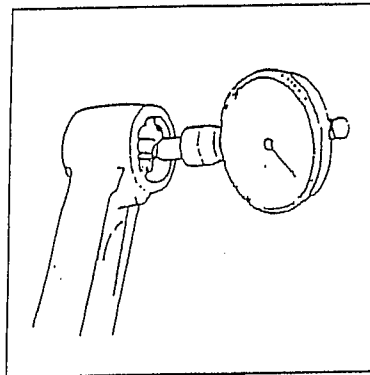

Limit of use: replace a new one when over 14.025mm. (T-REX 50)

## H. Installing cylinder and piston

1. Place the piston ring into the second ring ditch first, then install the piston ring into the first ditch.
2. a. Piston ring should be installed into piston ring ditch by even force.  
b. After assembling, be sure that the piston ring sliding surface is at the same height as the piston outer surface.  
c. If the piston ring can not fit into the ditch, please clean up the carbon in the piston ring ditch or piston ring itself.
3. a. Piston ring must be installed in the correct location.  
b. After installing the piston ring, it should be able to rotate freely.  
c. If it is necessary to change the new piston ring, it must change the whole set.
4. a. The location of the piston ring gap and the lock pin must be in opposite side.  
b. The mark "→" on the piston tip must be pointing to the exhausting port.  
c. Lubricate the piston pin before installation.
5. Please follow the opposite procedure of dismantling to install cylinder and cylinder head.

## (6) A.C. Generator, Flywheel

### A. Dismantling AC generator

1. Remove fan cowl.
2. Remove the M6 screws (4)
3. Remove Screws of flywheel magneto
4. Remove the AC flywheel magneto by special tool.

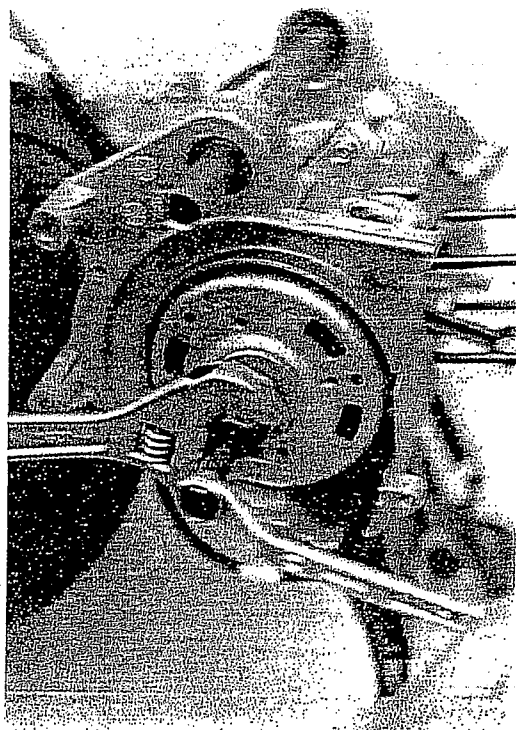
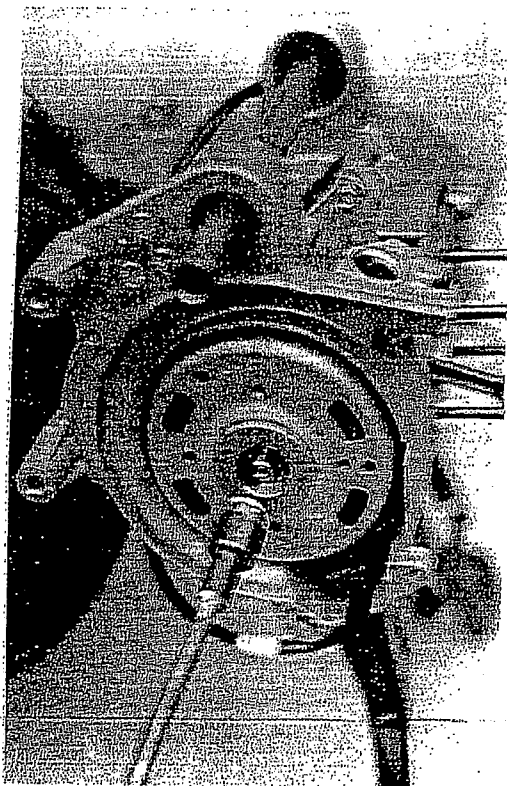
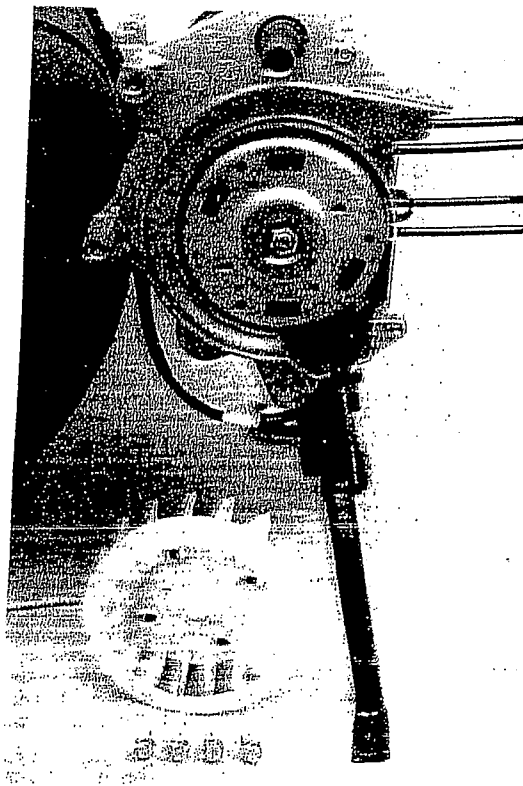

5.Remove the flywheel.

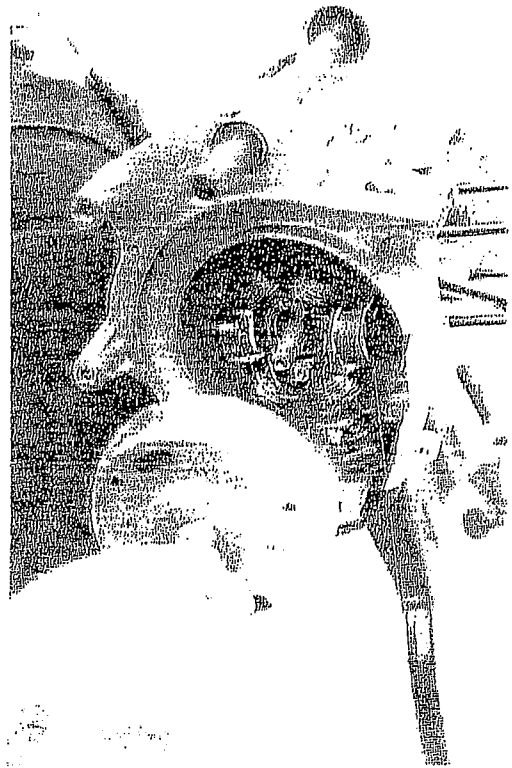

6.Remove the electric plug of  
AC Flywheel magneto.  
Take out the magneto.

B.Install AC generator

To install, please reverse the  
dismantling procedures.

Locking torque:

M6:1.0~1.2kg-m

M10:3.2~4.0kg-m

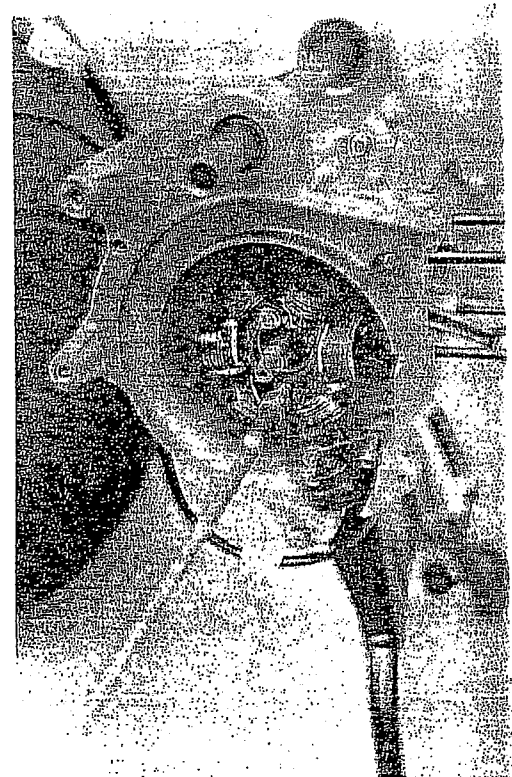

## (7) Final Transmission Mechanism

### A. Trouble shooting

- Engine can be started, but vehicle doesn't move.
  1. Gear worn-out or cracked.
  2. Gear burnt out.
- Noise occurs when running.
  1. Gear worn out, burnt or gear surface damaged.
  2. Bearing worn out or loosen.
- Oil leakage
  1. Too much oil.
  2. Seal worn out or damaged.

### B. Disassemble the final transmission mechanism.

1. Remove the rear wheel.

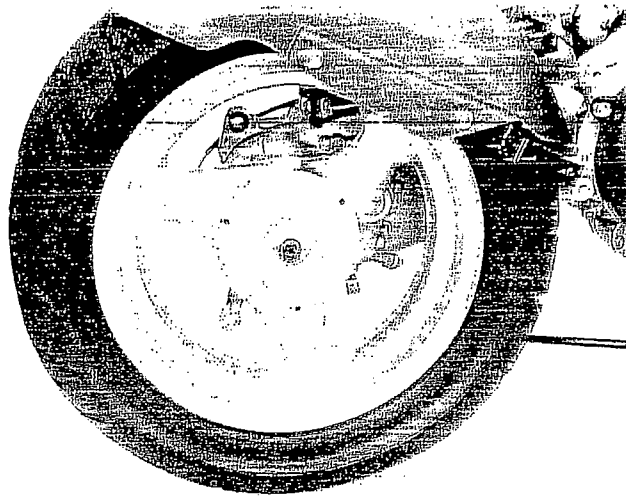

2. Drain off the oil in the gear box.

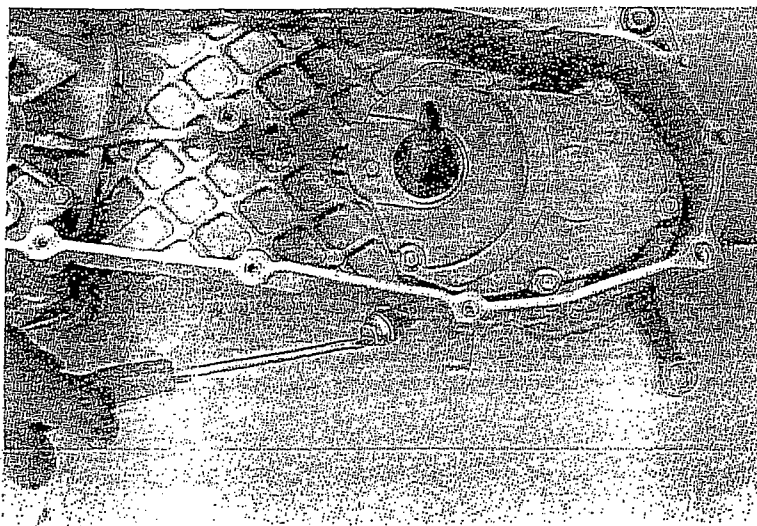

3. Remove the 6 bolts in the gear box cover.

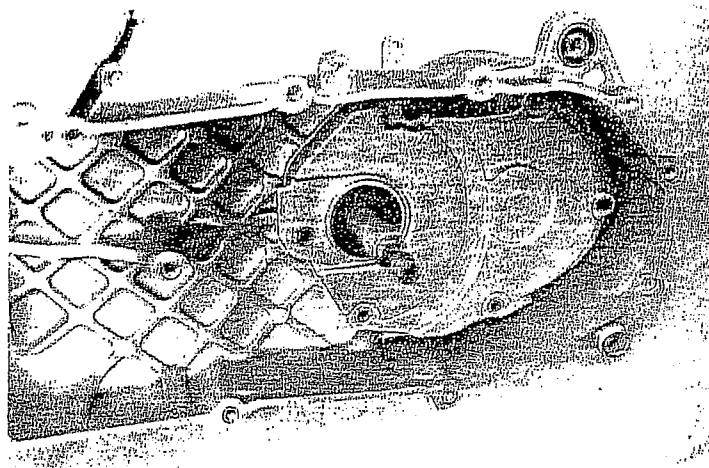
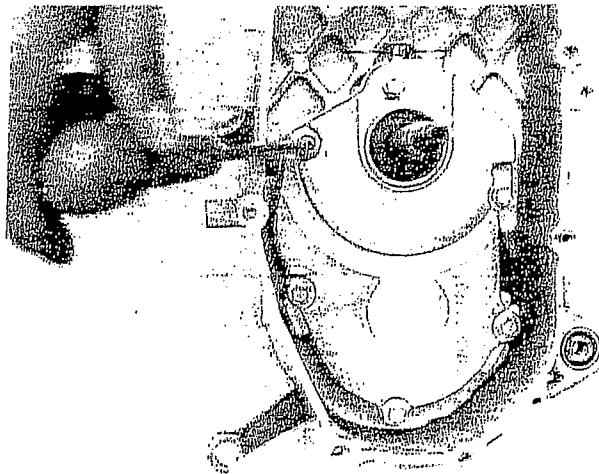

4. Take off the gear box.

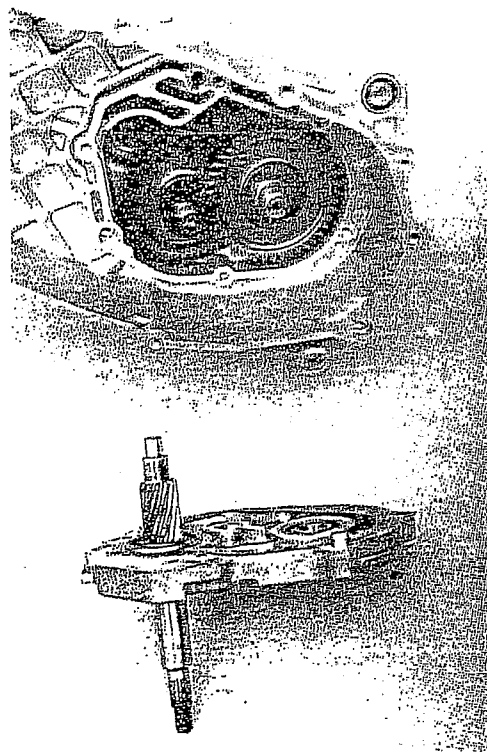

5. Take out the final reduction gear and idle gear.

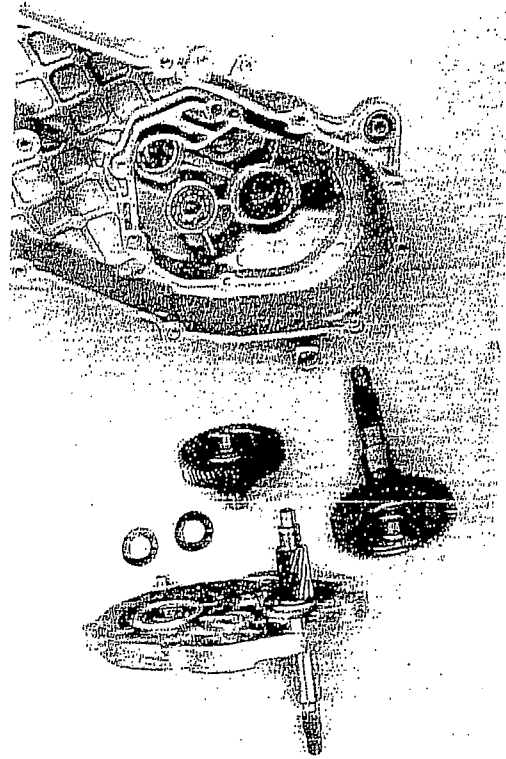

6. Clean up the gear box.

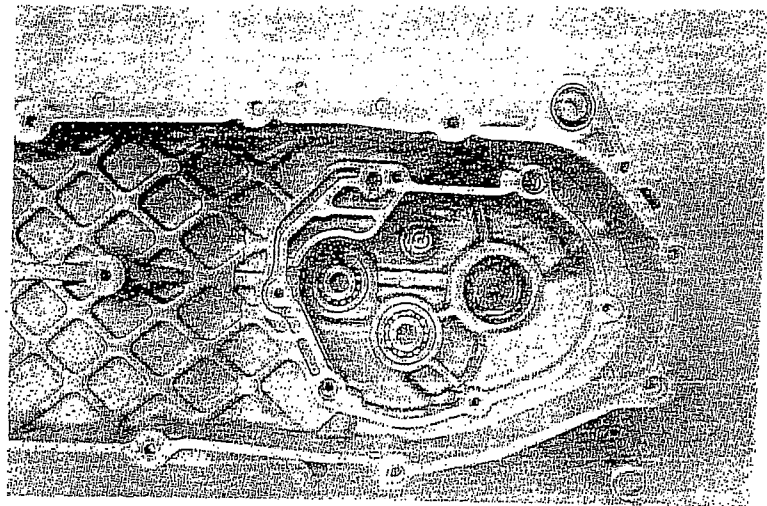

C. Check the final transmission mechanism

1. Check the wearing condition of the driving shaft and gears.

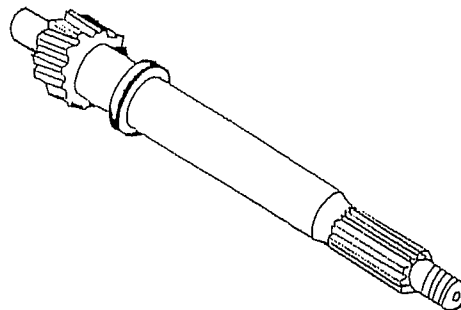

2. Check the wearing condition of the idle gear shaft and idle gears.

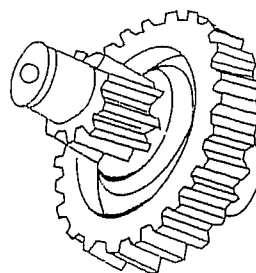

3. Check the wearing condition of the final reduction gear.

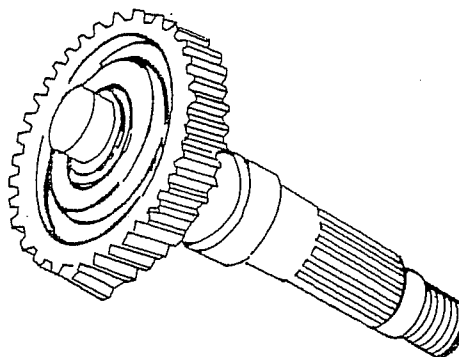

4. Check the wearing condition of the oil seal and bearing.

D. Assemble the final transmission mechanism: please follow the opposite procedures of disassembling. After locking the drain bolt, refill 90c.c. of gear oil, SAE 85W/140.

Locking torque:	M6:1.0~1.2kg-m
	M10:3.5~4.0kg-m
Drain bolt:	M8:1.8kg-m



(8)Crankcase, Crankshaft:

A.Disassembling diagram

Locking torque:1.0~1.2kg-m

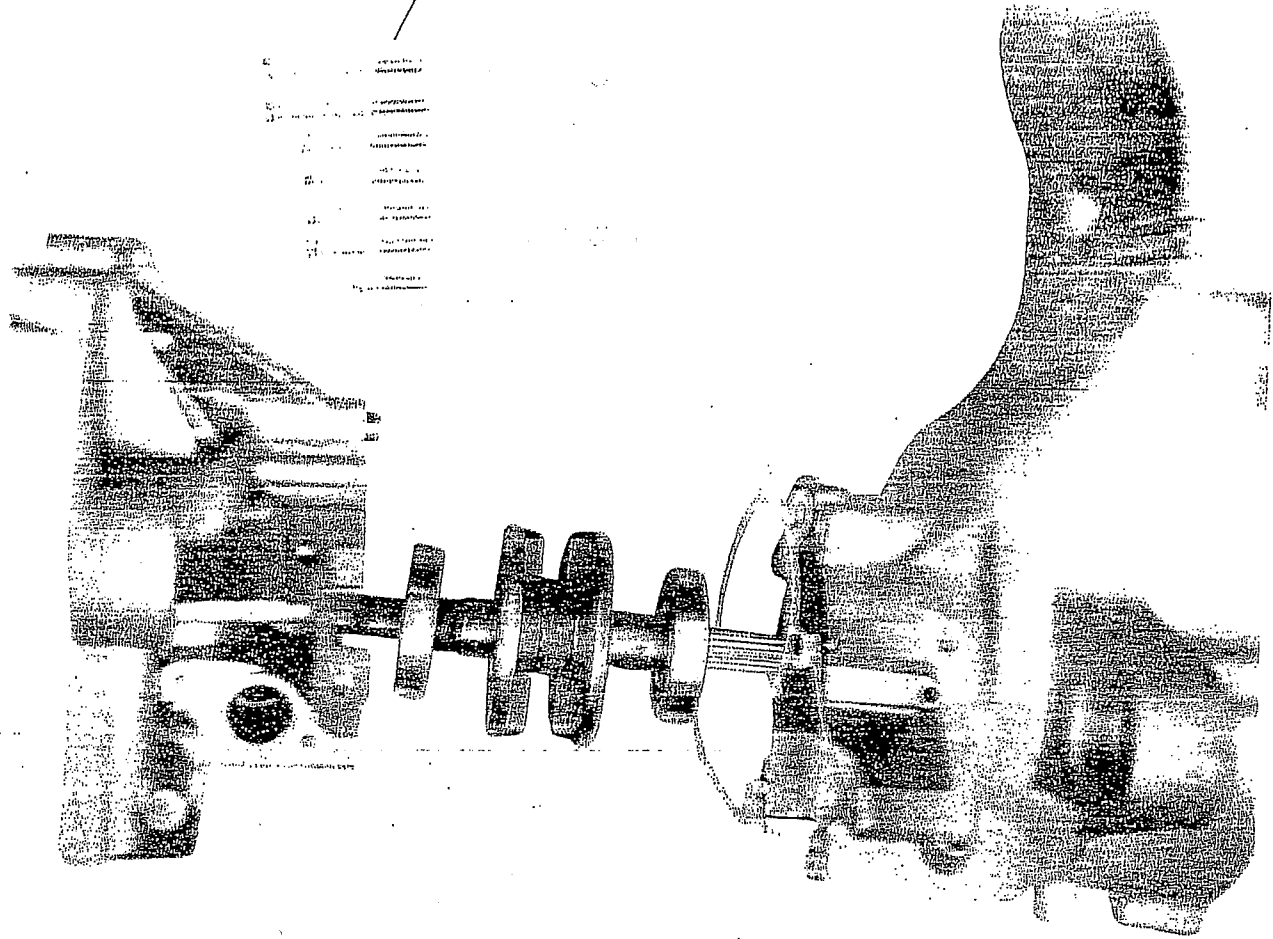

## B. Troubleshooting

· Engine noise:

1. The bearing of the final transmission mechanism is loose.
2. Crank pin bearing is loose.
3. The bearing of gear box is loose.

## C. Data

Measuring Item	Standard value	Limit of use.(mm)
Clearance of connecting rod big end (Parallel direction of rod)	0.20-0.50	0.71(50cc)
Clearance of connecting rod big end (Perpendicular direction to rod)	—	0.04
Swingness of the crank shaft neck	0.03	0.10

D. Dismantle the crankcase and crankshaft please follow the following procedures:

1. Remove the engine.

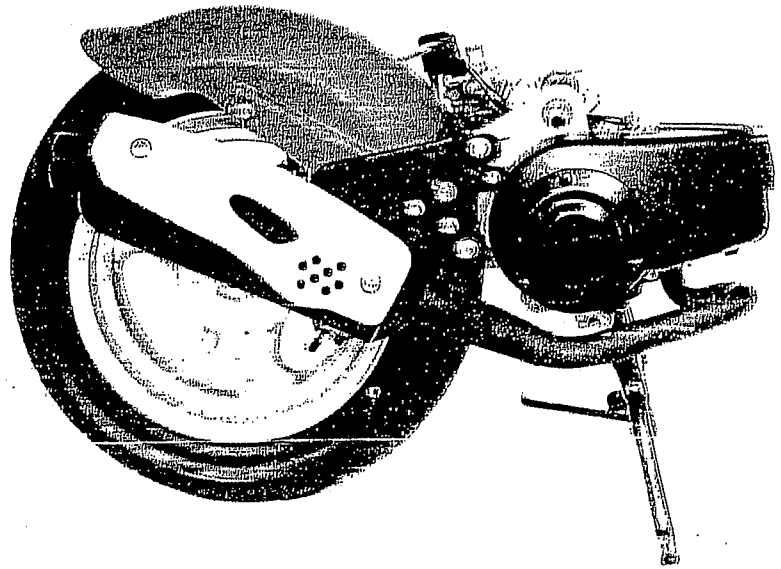

2. Remove the left crank case, the driving pulley (driving plate), clutch and belt.

3. Remove the air cleaner.

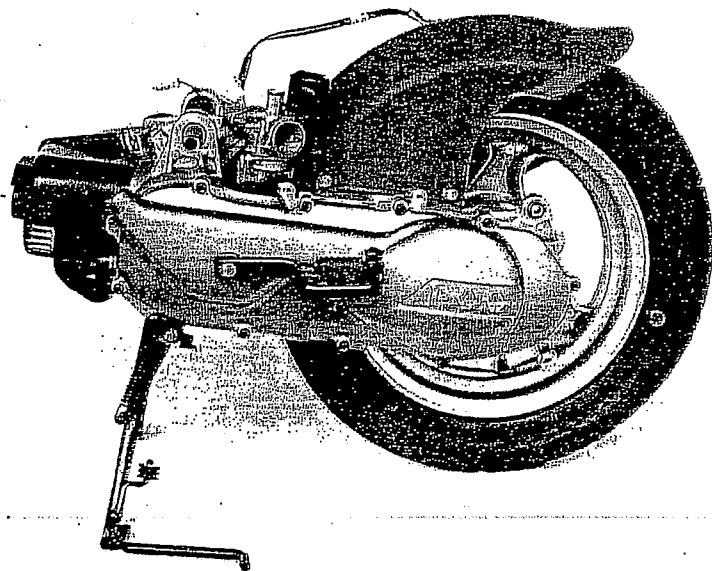

4.Remove the carburetor.

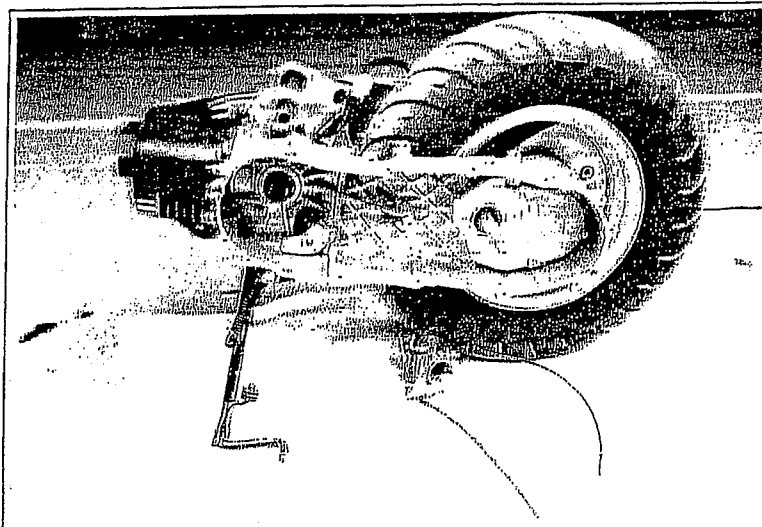

5.Remove the intake manifold and reed valve.

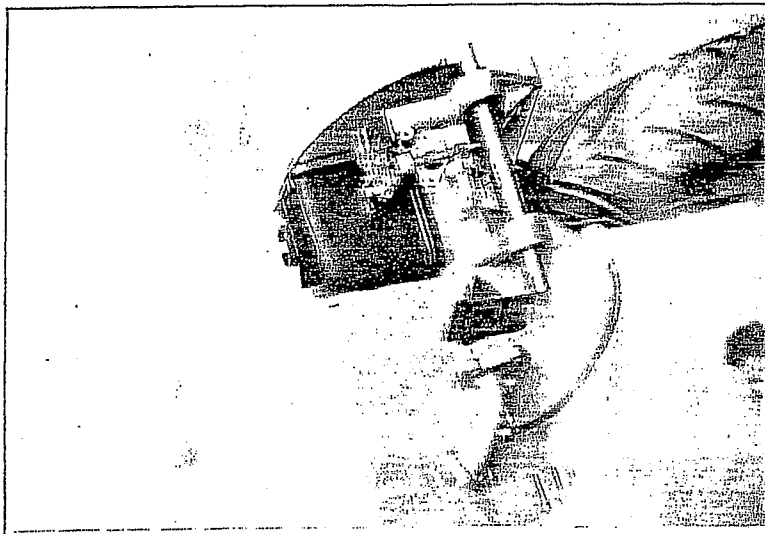

6.Remove the oil pump, fan cover, fan cowl and fan itself.

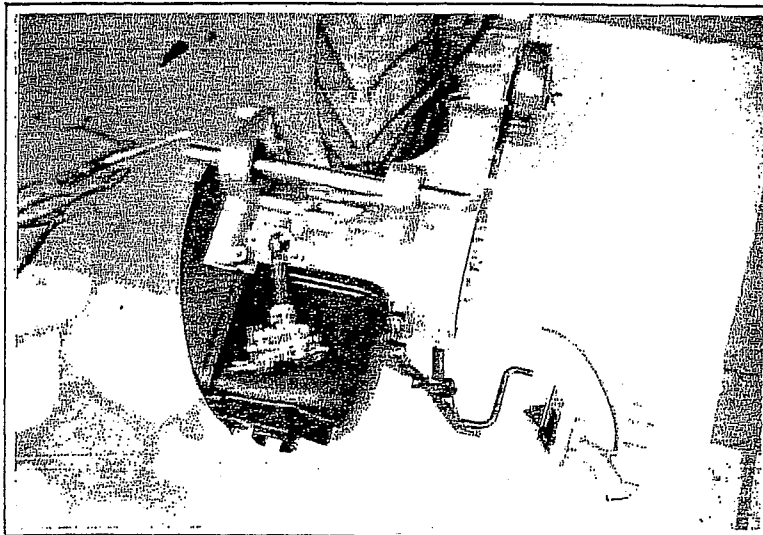

7. Remove the AC flywheel magneto.

8. Dismantle the right and left crankcase.  
There are altogether 7 bolts.

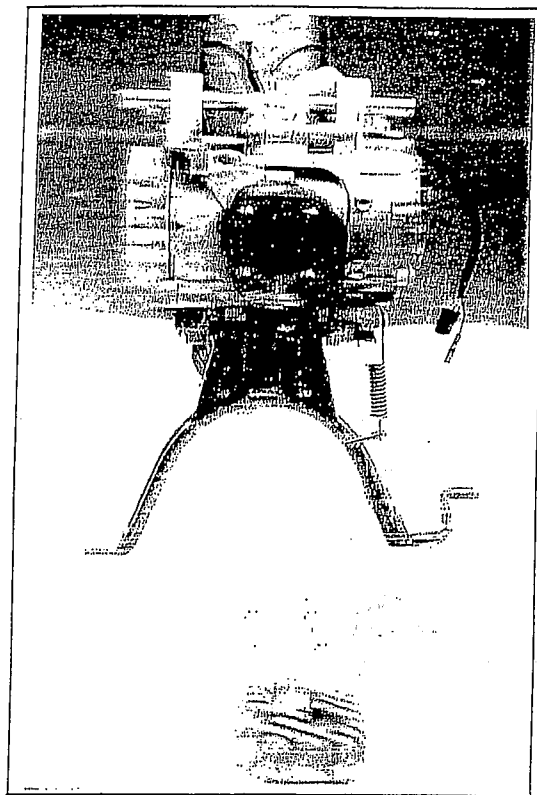
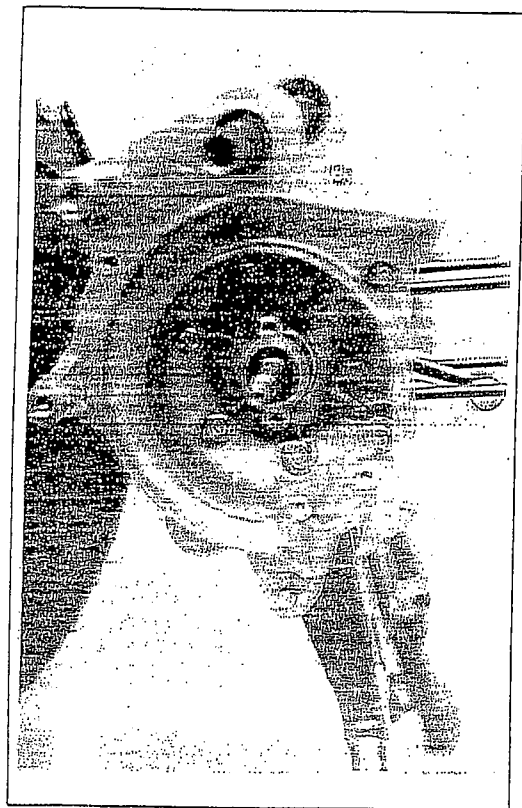

9. Remove the center stand, left and right crankcases and take out the crankshaft.

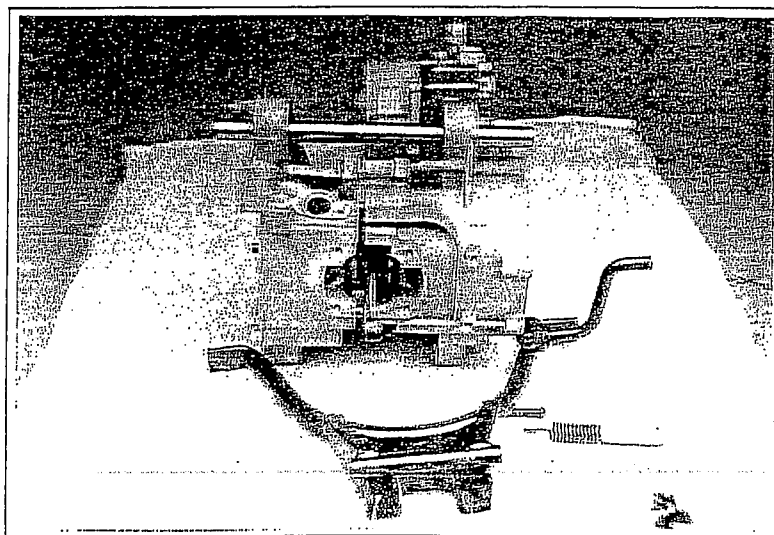

E. Check the crankshaft:

1. Measure the clearance between the crank shaft and connecting rod big end. (Parallel direction to rod)

Limit of use:

Replace a new one when above 0.71mm

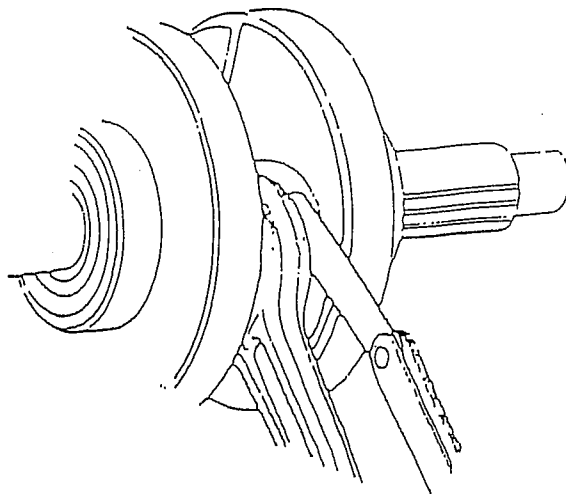

2. Check the looseness on X.Y axis of the connecting rod big end. (Perpendicular direction to rod)

Limit of use:

Replace a new one when above 0.04mm

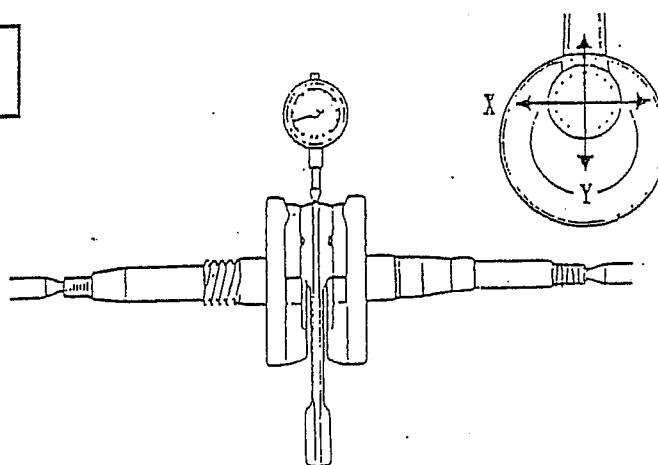

3. Measure the swingness of the crankshaft neck.

limit of use	
A	B
change it when above 0.1mm	change it when above 0.1mm

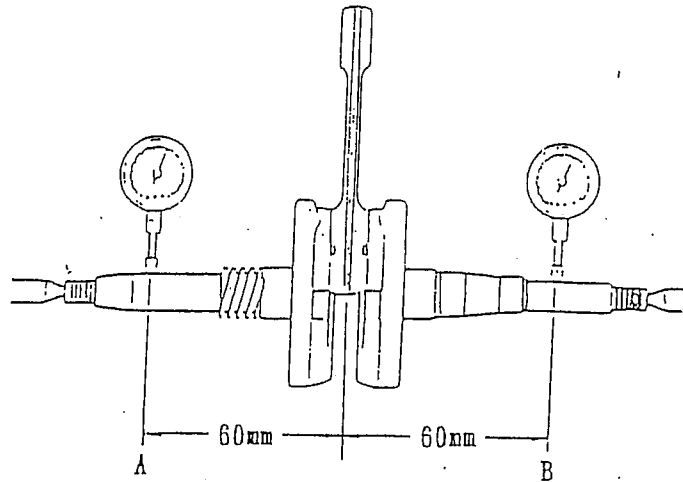

4. Check the slackness of crankshaft bearing.  
if it is slack, replace a new one.

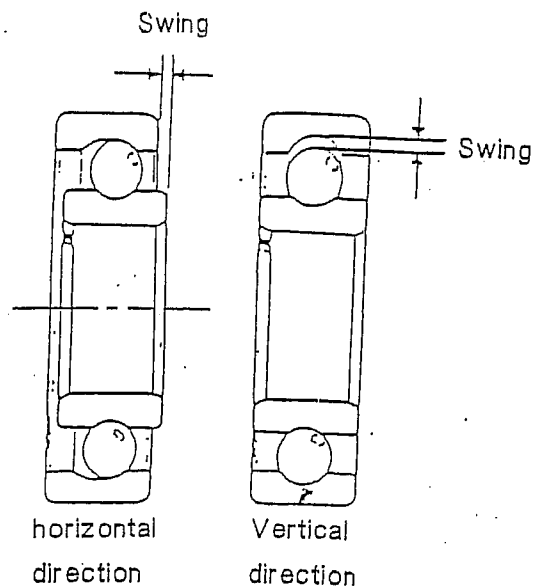

F. Assemble the crankcase.

1. To assemble the crankcase, please reverse the procedures of disassembly.
2. The locking torque value for bolts and nuts are all described in the previous chapters please refer.

(9) Carburetor, Reed Valve and Auto cock  
A. Fuel system diagram

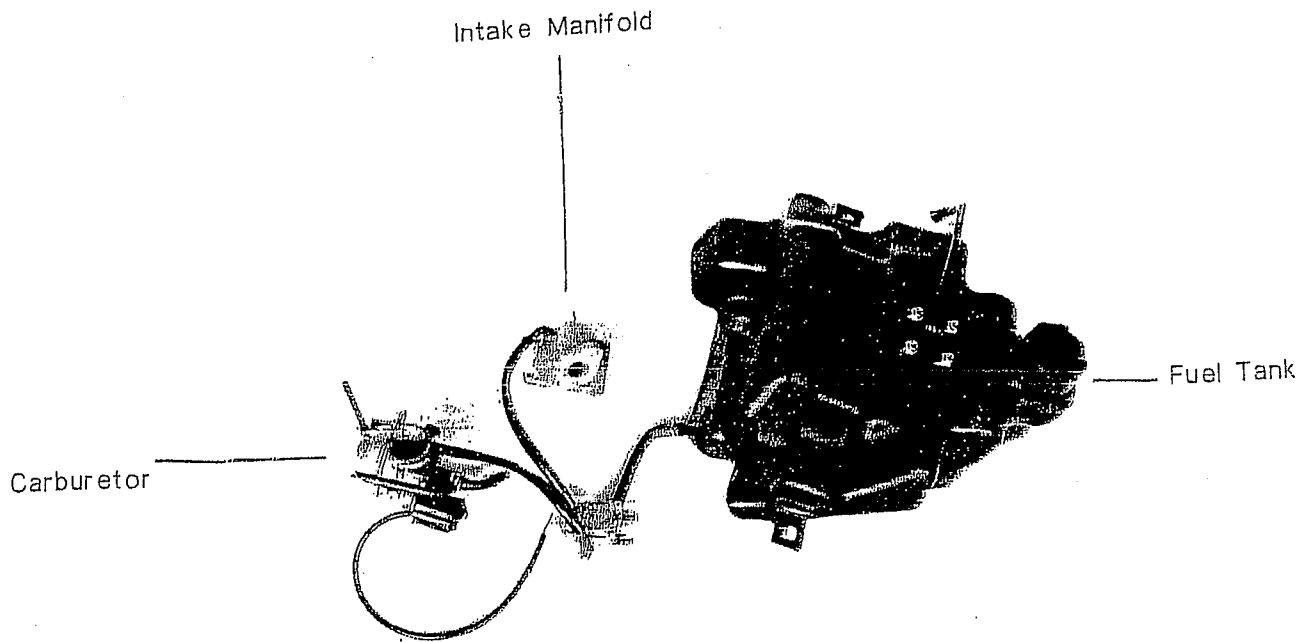

B: Carburetor dismantling diagram

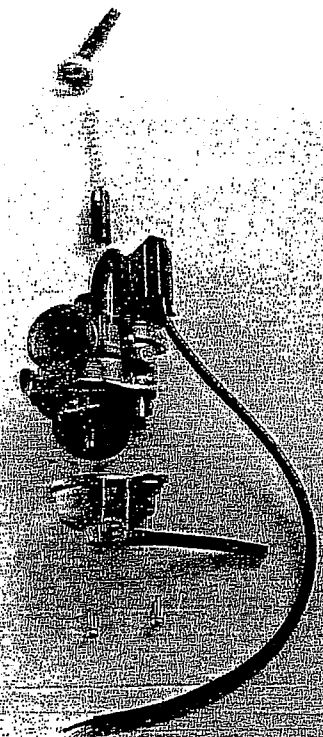



C. Troubleshooting:

a. Engine can not be started.

1. No fuel in the fuel tank.
2. Fuel pipe is blocked.
3. There is too much fuel in the cylinder.
4. Air cleaner is blocked.

b. Engine idling (RPM) unsteady, running not smoothly

1. Improper adjustment of the carburetor idling.
2. Ignition disorder.
3. Compression pressure is too low.
4. Air mixture is too thick.
5. Air mixture is too lean.
6. Air cleaner is blocked.
7. Air injection is not in good function.
8. Fuel is dirty.

c. Air mixture is too lean.

1. Carburetor main jet is blocked.
2. The ventilation hole of the fuel tank cover is blocked.
3. Fuel filter is blocked.
4. Fuel pipe bended, squeezed or blocked.
5. Float valve is abnormal.
6. Fuel level is too low.
7. Air pipe is blocked.

d. Air mixture is too thick

1. Float valve is abnormal.
2. Fuel level is too high.
3. Air jet is blocked.

#### D. Dismantling carburetor

1. Remove the luggage box.
2. Loosen the hose clamp between the carburetor and the air cleaner. Then remove the air cleaner.
3. Unscrew the fuel draining screw of the carburetor. Drain off the fuel inside the carburetor.
4. Remove the fuel pipe and the vacuum pipe on the carburetor.
5. Remove the oil pipe on the carburetor.
6. Remove the bolts on the intake manifold and carburetor.

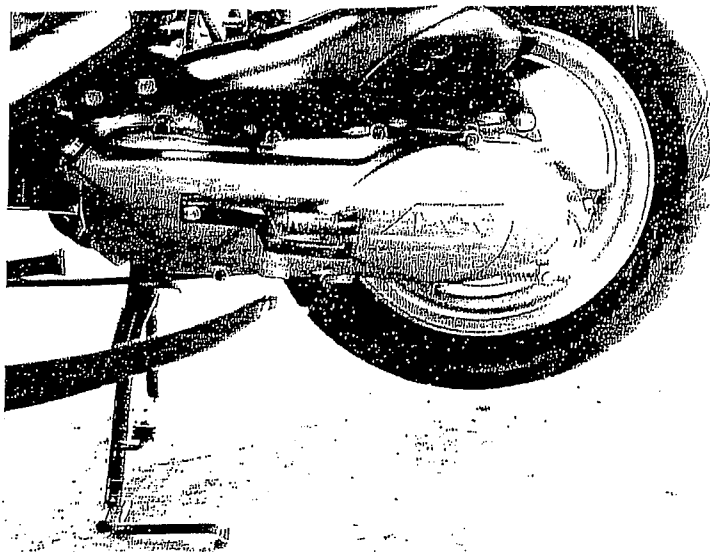

#### E. Dismantling float, nozzle

**Note:**

The auto choke has been properly adjusted already. Please do not adjust it further. When there is blockage in the carburetor, please clean it by air compressor.

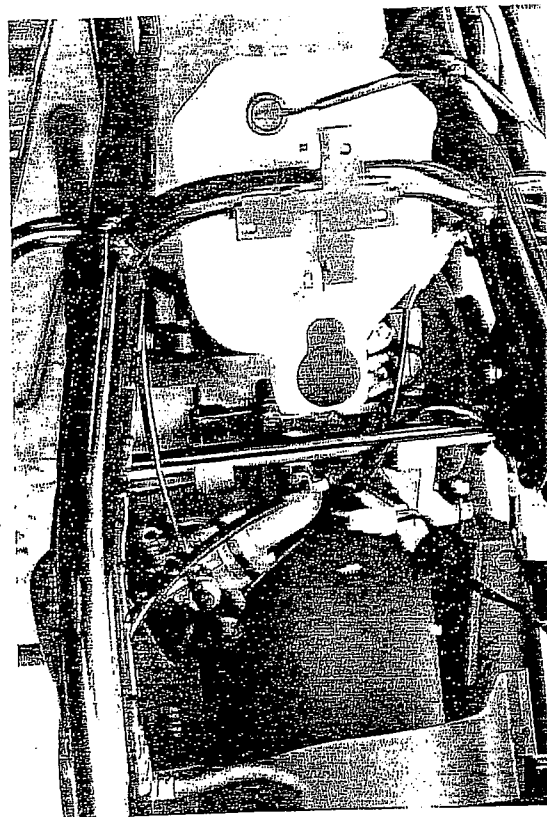

#### G. Float needle check

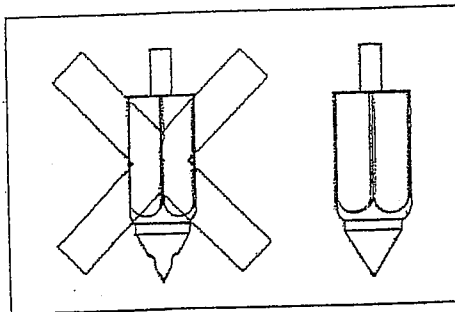

## F. Reed valve

### 1. Dismantling reed valve.

- (1) Take off the luggage box.
- (2) Remove the air cleaner
- (3) Remove the carburetor.
- (4) Unscrew the locking screw of the intake manifold.



- (5) Remove the intake manifold.

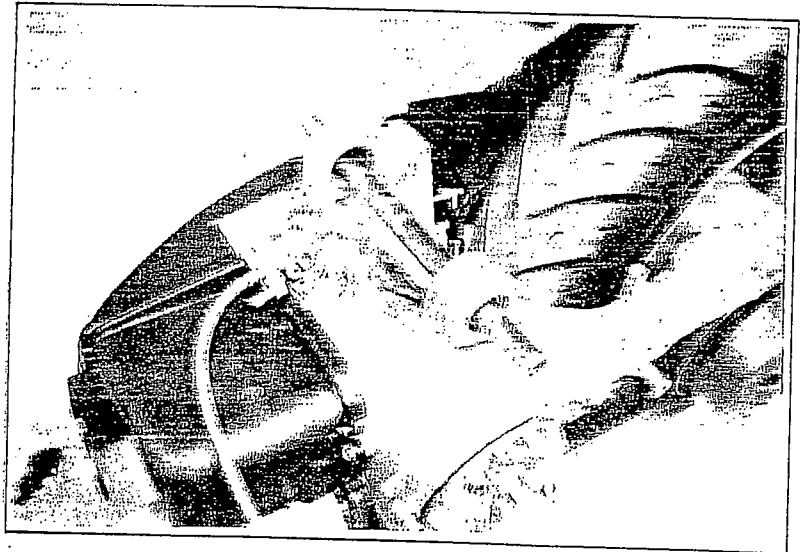

- (6) Remove the reed valve.

### 2. Checking for the reed valve.

- Change a new one when the reed valve is worn out or distorted.
- Change a new one too when the base of the reed valve is cracked, injured or distorted.

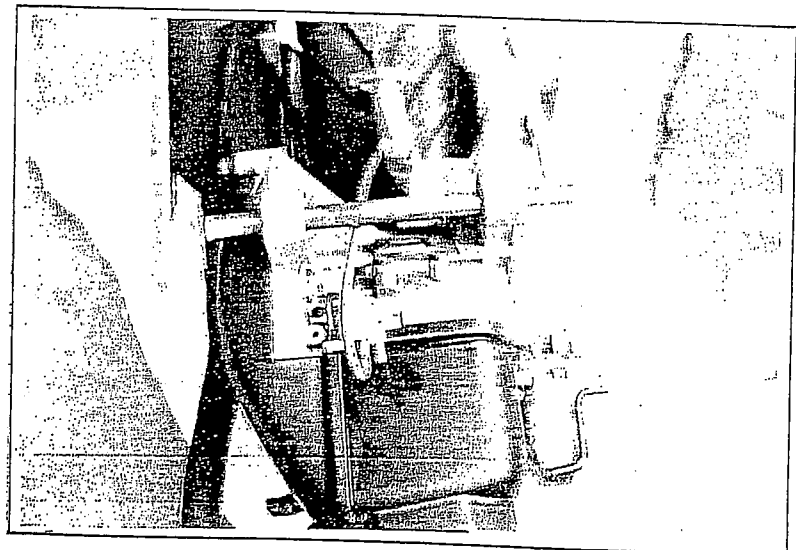

### G. Check the auto cock

1. When the engine stop, remove the fuel pipe from carburetor and check if there is fuel flow out or not.

It means auto lock functions well if the residue fuel (for the amount of 5-10cc) flows out from the auto cock and fuel pipe. However, if it continues to flow out, it means that the vacuum pipe is blocked. Please clean it.

2. Remove the vacuum pipe from the carburetor and suck it to produce a vacuum to have the fuel flow out from the fuel pipe. The fuel will stop flowing out if the vacuum disappear. If the fuel does not flow out by the above operation, please check the followings.

(a) Clean out blockage in the vacuum pipe.

(b) Blow air into the inlet pipe of the auto cock.

### 3. Note:

Please remember to use a bowl to catch the flow-out at the end of the fuel pipe. Keep away from fire or even spark during operation.

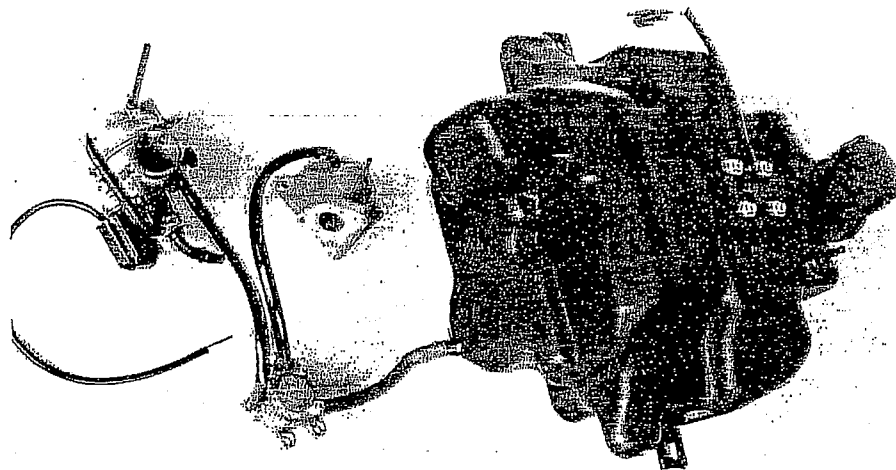

(10) Handle bar, Front Wheel, Front Brake and Front Fork:

A. Troubleshooting

1. Steering handlebar is abnormal, too tight.
  - a. Steering mechanism; washer of conical bush locked too tightly.
  - b. Steering mechanism; steel ball is cracked.
  - c. Steering mechanism; steel ball base and washer of conical base is damaged.
  - d. Wheel pressure is too low.
  
2. Steering handlebar is aslant.
  - a. Left and right damper are not even.
  - b. Front fork is crooked.
  - c. The axle of front fork is crooked, or the wheel is aslant.
  
3. Front wheel swings.
  - a. Wheel rim is distorted.
  - b. Bearing of front axle is loose.
  - c. Wheel spoke is distorted.
  - d. Tire worn out.
  - e. The wheel axle is improperly assembled.
  
4. Front damper is too soft, or spring fatigue.
  
5. Noise in front damper.
  - a. Noise comes from the shock absorber tube.
  - b. Locking screw of damper is loose.

B. Data

Item	standard value(mm)	limit of use.(mm)
Lining of frt pad	5.3	3.3
Disk of frt brake	3.5	3.0
Swingness of frt/rr wheel	—	2.0
The lining of rr brake	4.0	2.0

C. Change the speedometer cable:

1. Remove the front handle cover.
2. Remove the nut of the speedometer cable.

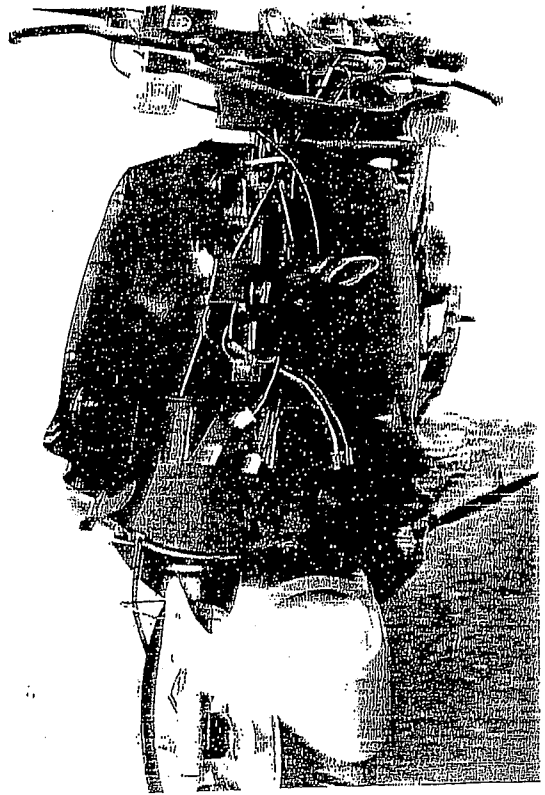

3. Remove the fixed screw of speedometer cable on the front wheel.
4. Pull out the damage speedometer cable.
5. To assemble the new cable, Please follow the opposite of dismantling procedures.

Note: Put the grease onto the inner cable before assembling.

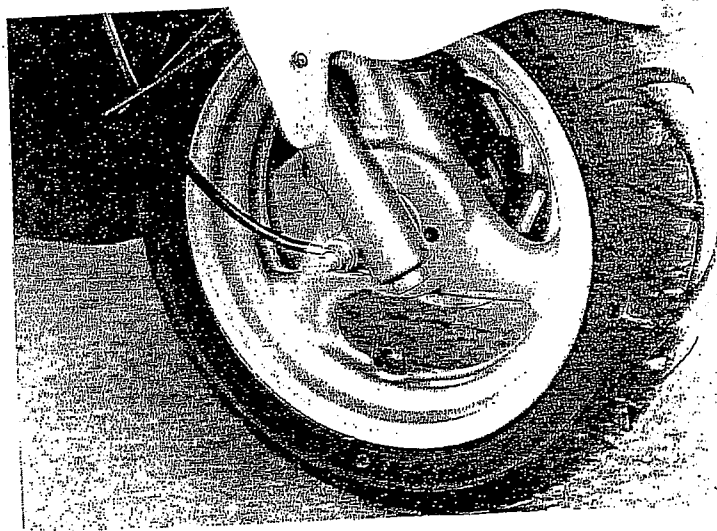

D. Steering handlebar.

1. Remove the LH/RH back mirrors.

2. Remove the front handle cover.

3. Remove the rear handle cover speedometer and plugs of switches.

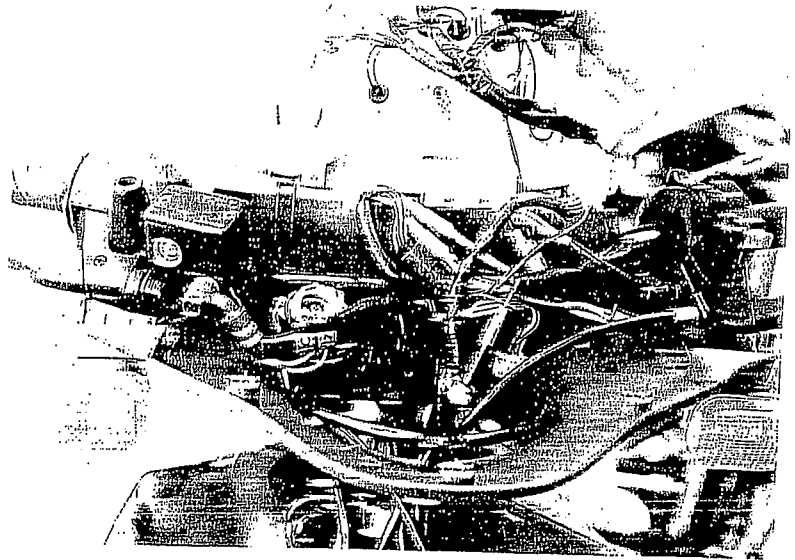

4. Remove the terminal of the rear brake and the switch plug of the rear brake lamp.

5. Loosen the throttle cable pulley's cover.

6. Remove the throttle cable and RH grip assembly.

7. Remove the locking bolt of the front brake's master cylinder on the steering handlebar, then remove the front brake's master cylinder.

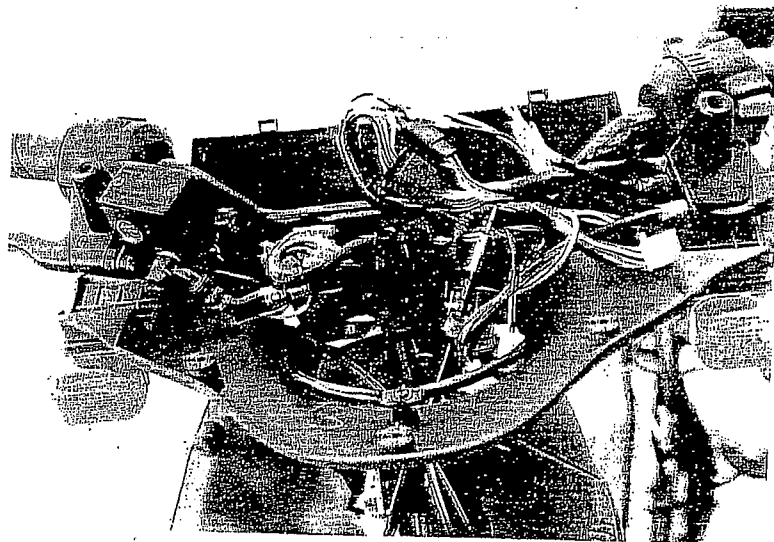

8. Remove the bolts and nuts fixed the handlebar of the front damper.
9. Remove the steering handlebar.
10. To assemble the handlebar, please follow the opposite dismantling procedures.  
Locking torque:  
M6: 1.0-1.2kg-m  
M10: 3.0-4.0kg-m
11. Before assembling, please put the grease onto the cables.

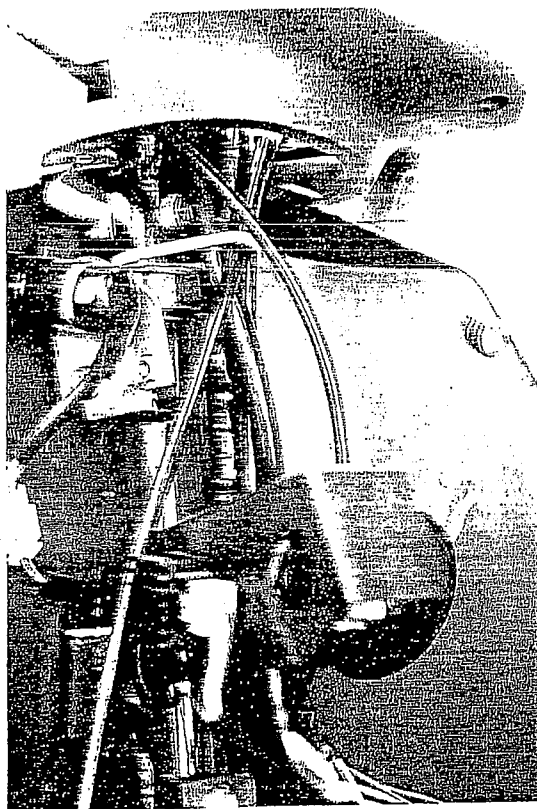



F. Front wheel:

1. Remove the locking nut of the front wheel on the right side.

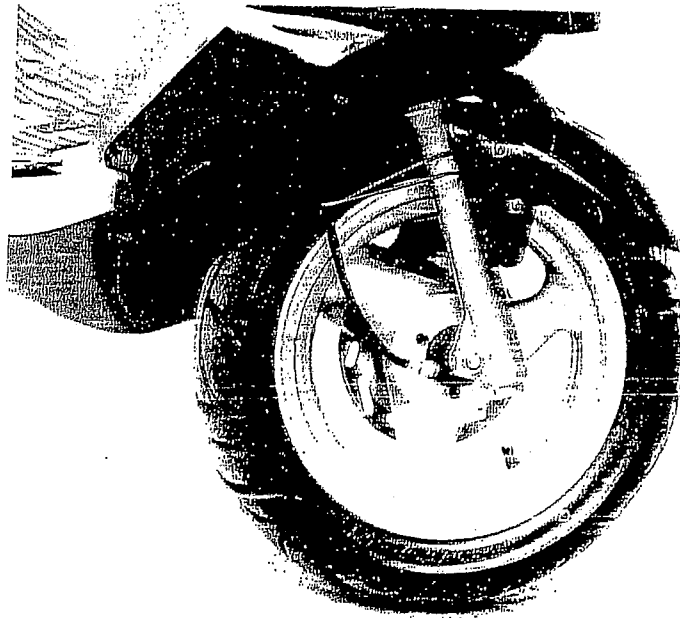

2. Pull out the axle of front wheel. Remove the spacer ring and take off the gear sets of the speedometer.
  3. Remove the front wheel assembly.
  4. To assemble, please reverse the procedures of dismantling.
- Locking torque: M12: 5.0~6.0kg-m

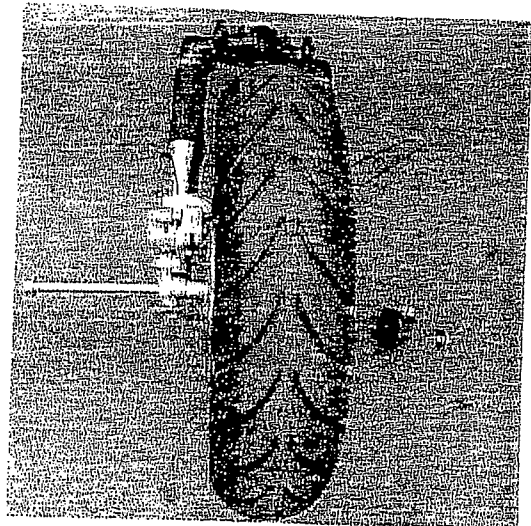

- Note: 1. Put the movement-stop block of the speedometer gear assy above the extruded block of the front fork.
2. Please put the grease onto the gear sets of the speedometer before assembling.

5. Checking the front axle
- Check the bending degree of the front axle.
  - Limit of use: change it when above 0.2mm

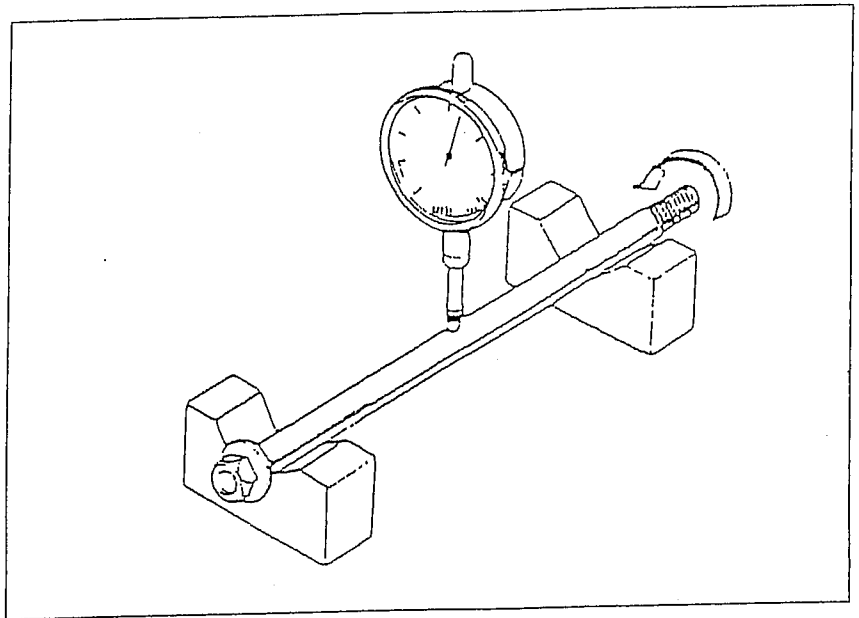

6. Check the front wheel bearing.
- Rotate the wheel.
- If any noise or slackness is found, please change a new one.

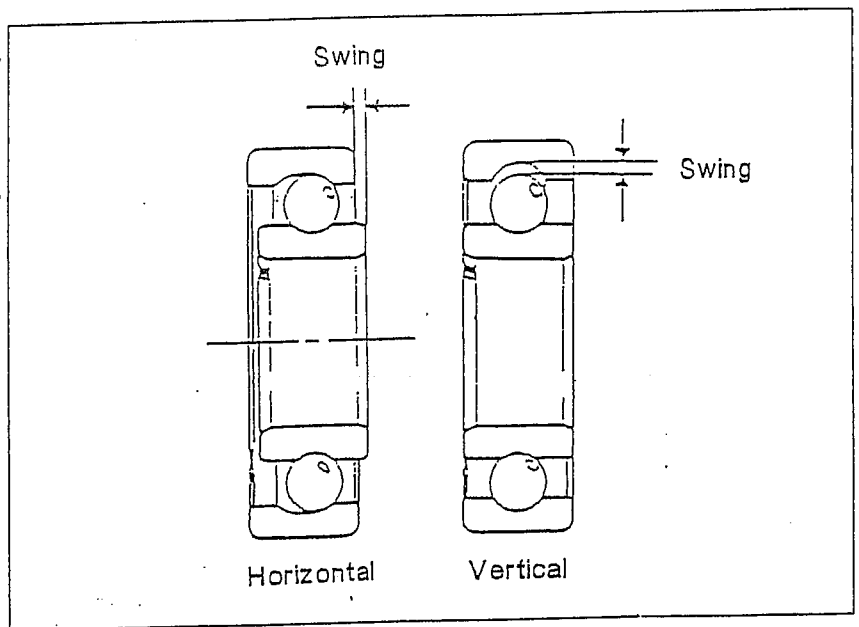

7. Front wheel rim checking.
- check the swingness of the front wheel rim.
  - Limit of use:
    - Horizontal direction: change a new one when above 2.0mm.
    - vertical direction: change a new one when above 2.0mm.

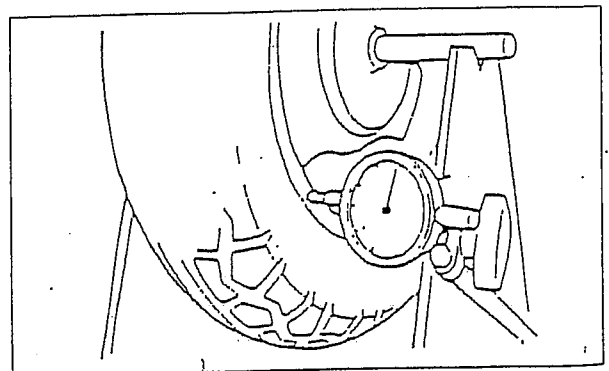

## F. Front Brake

1. Assembling and disassembling the front brake comp.
  - a. Remove the two bolts fixed on the frt. brake comp. from the front fork.
  - b. Remove the frt brake comp.
  - c. To assemble the frt brake comp, please reverse the dismatling procedures.

Locking torque:  
M8: 2.0~3.0kg-m

## 2. The releasing of air from the frt brake comp.

The procedures:

- a. Fill in the appropriate brake fluid to the storage tank.
- b. When assembling the master cylinder cover, do not let the brake fluid overflow from the master cylinder of storage tank.
- c. Put the spanner upon the drain screw of the caliper.
- d. Lock and unlock the screw repeatedly drain off the bubble.
- e. Operate slowly the brake lever several times.
- f. Pull the brake lever fully closed.
- g. Loose the drain screw, then release the lever fully opened.
- h. Locking the drain screw when the lever is fully opened.
- i. Repeat the above procedure until all air within the brake system is released completely.

Locking torque of leaking screw: 0.6kg-m

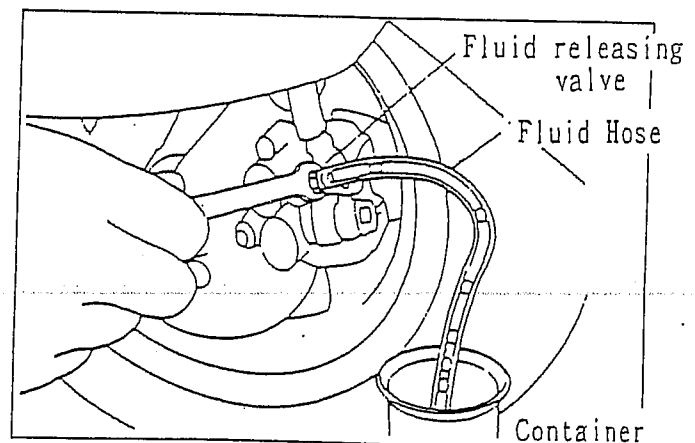
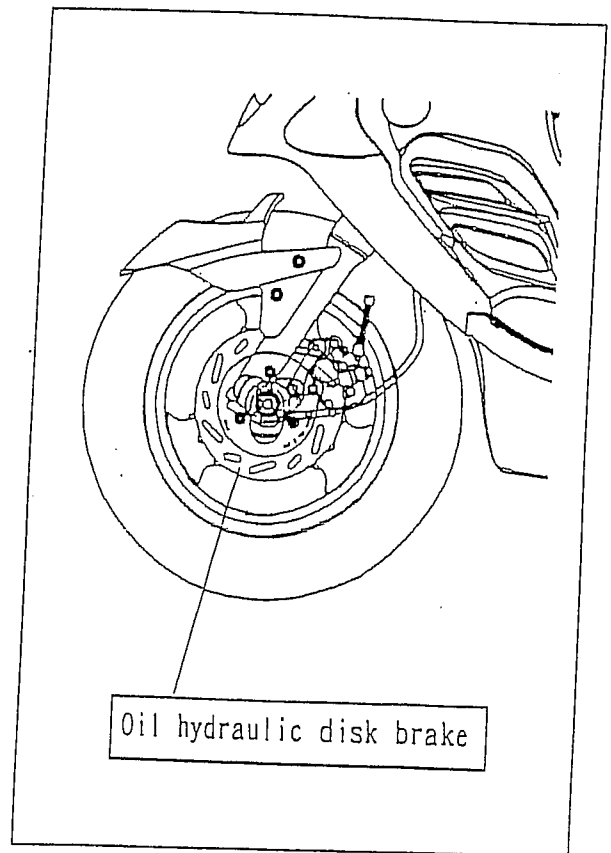

3. Disassembling and assembling the front brake disk.

a. Remove the front wheel.  
b. Remove the three nuts on the disk.

c. Remove the disk.

d. To assemble the disk, please reverse the disassembling procedure.

Locking torque M8: 2.0~3.0kg-m

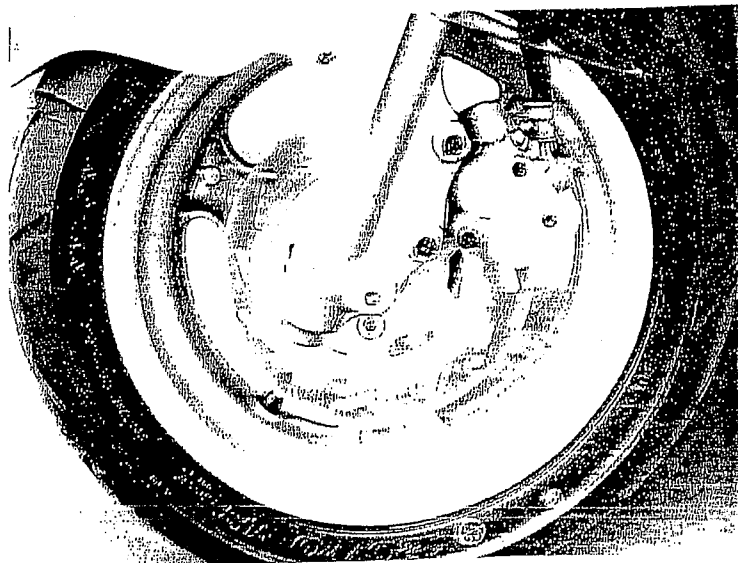

4. Checking for the brake disk Standard thickness: 3.6mm

Limit of use:  
Replace a new one when below 3.0mm.

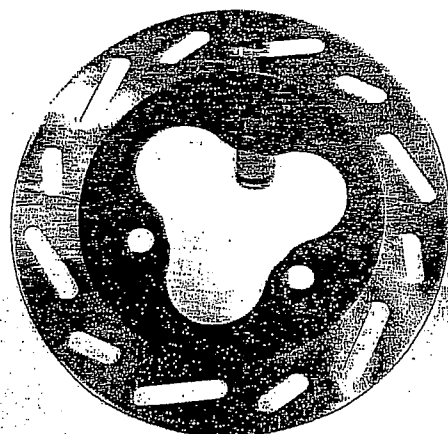

5. Checking the front brake lining.

a. Standard thickness: 4.0mm.

Limit of use: Replace a new one when the thickness is below 3.3mm

Note: No grease allowed on the lining.

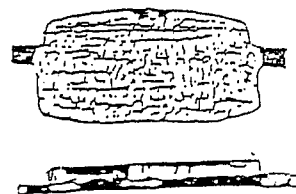

G. Front fork

1. Front fork system diagram.

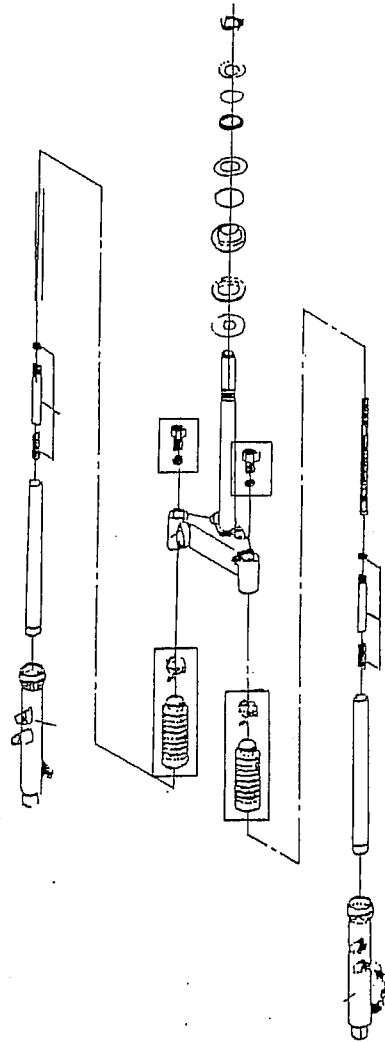

2. Checking front fork:

Please change a new one if it is distorted.

3. Checking front damper:

Check the guiding rod of damper if it is bended. Also check if there is abnormal worn out or damage.

Note: Change a new guiding rod if it is bended

(11)Rear wheel, Rear Brake, Rear Damper:

A. Troubleshooting.

1. Rear wheel swings.
  - a. Wheel rim is distorted.
  - b. Tire worn out.
  - c. The wheel axle is improperly assembled.
2. Rear damper is too soft.
  - a. spring fatigue.
3. Bad braking
  - a. The adjustment of brake is not proper.
  - b. The brake lining is dirty.
  - c. The brake lining worn out.
  - d. The cam of brake lining worn out.
  - e. The brake cam lever worn out.
  - f. The wheel hub worn out or damaged.
  - g. The operation on the brake arm tooth is not good.

B. Data

Item	Standard value(mm)	limit of use(mm)
The swingness of rear wheel	—	2.0
Wheel hub (inner diameter)	110	111.0
Thickness of brake lining	4.0	2.0

C. Disassembling and assembling the rear wheel.

1. Remove the rear mudguard and the exhaust pipe.
2. Remove the locking nut of the rear wheel.
3. Remove the rear wheel.
4. To assemble the rear wheel, please reverse the dismantling procedures.

Locking torque: M6: 0.7-1.1kg-m M14: 8.0-10.0kg-m
--

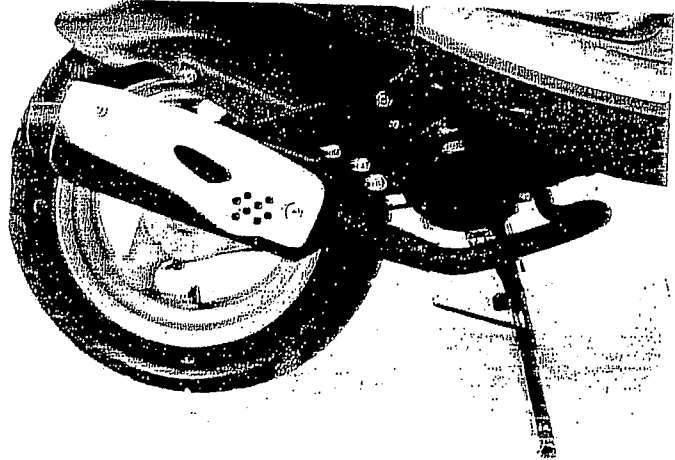

D. Checking the rear wheel.

- a. Check the swingness of rear wheel.
- b. Vertical direction:  
Change it when above 2.0mm
- c. Horizontal direction:  
Change it when above 2.0mm

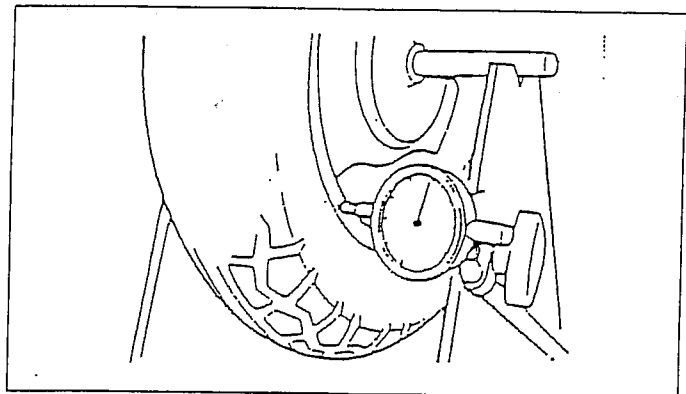

E. Rear brake:

1. Rear brake disassembling diagram.

(1) Checking the rear brake hub:

- a. Measure the inner diameter of the rear brake hub.
- b. Limit of use: change it when above 111.0 mm

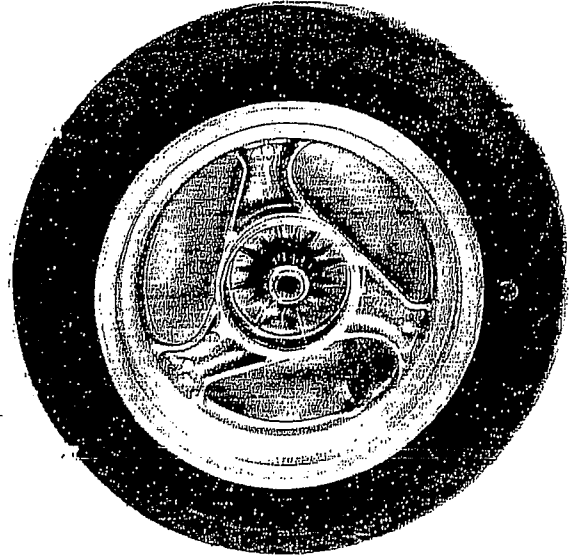

(2) Checking the brake lining:

- a. Measure the thickness of the rear brake lining.
- b. Limit of use: As the thickness is less than 2mm, change it.

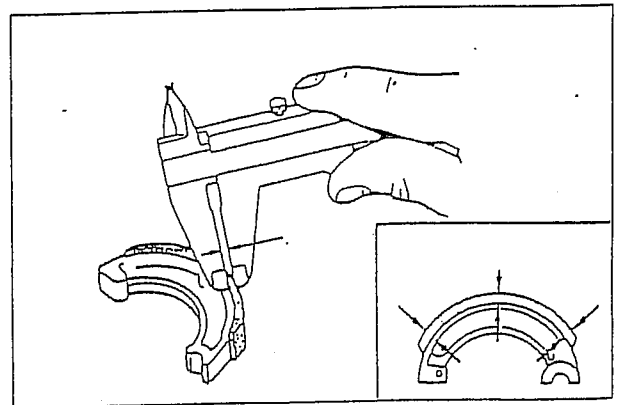
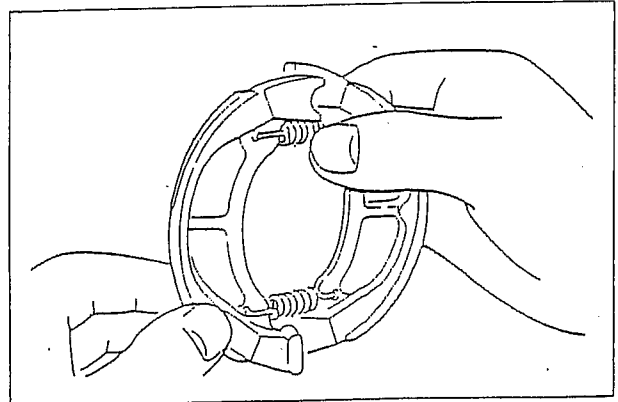



F.Rear damper

1.Rear damper disassembling diagram:

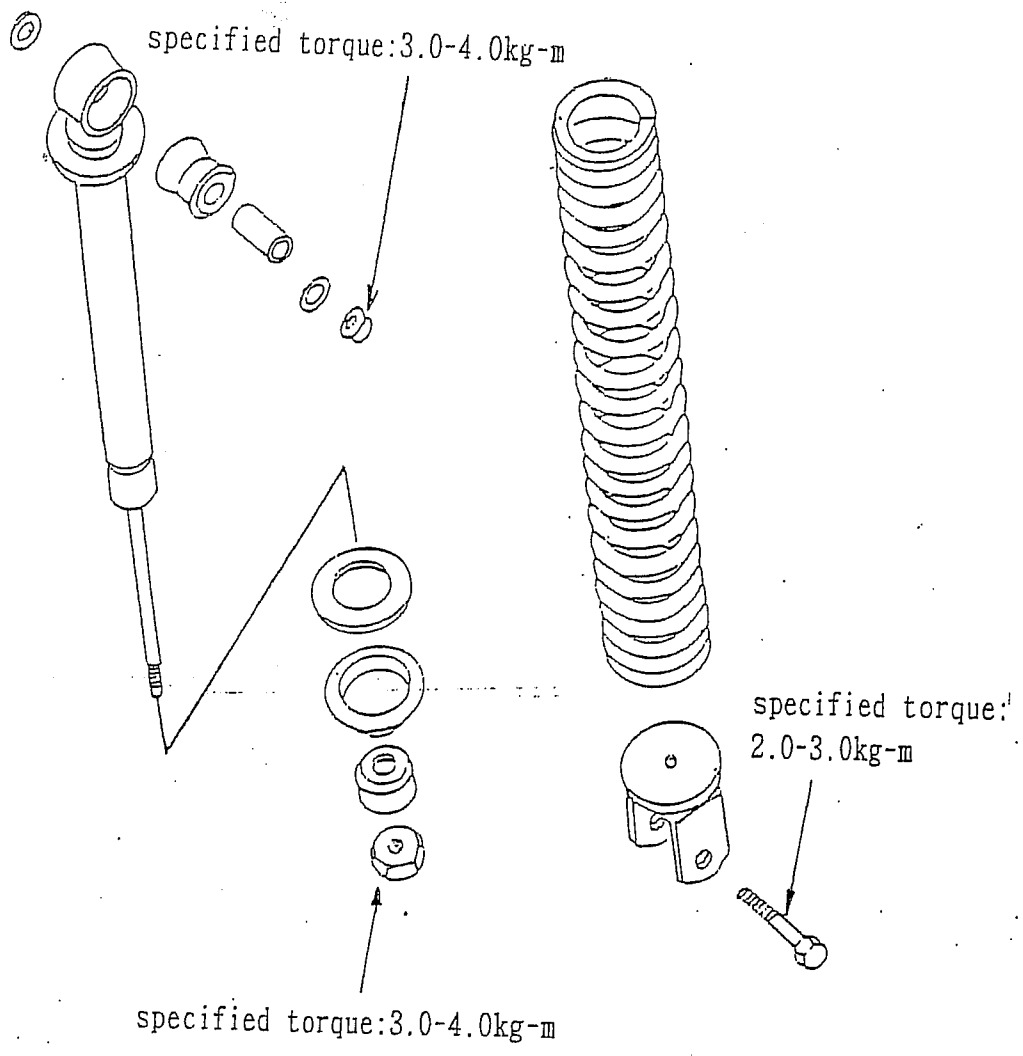

## (12) Fuel Tank

### A. Troubleshooting.

1. Engine can't start:
  - a. No fuel in fuel tank.
  - b. Fuel pipe is blocked.
  - c. Auto cock and filter is blocked.
  - d. The membrane of auto cock is over swell.
2. The membrane of auto cock is over-extended.
  - a. Fuel tank cover's ventilation hole is blocked.
  - b. Fuel pipe is crooked, squeezed, or blocked.
  - c. Auto cock and fuel filter is dirty.

### B. Fuel tank disassembling diagram.

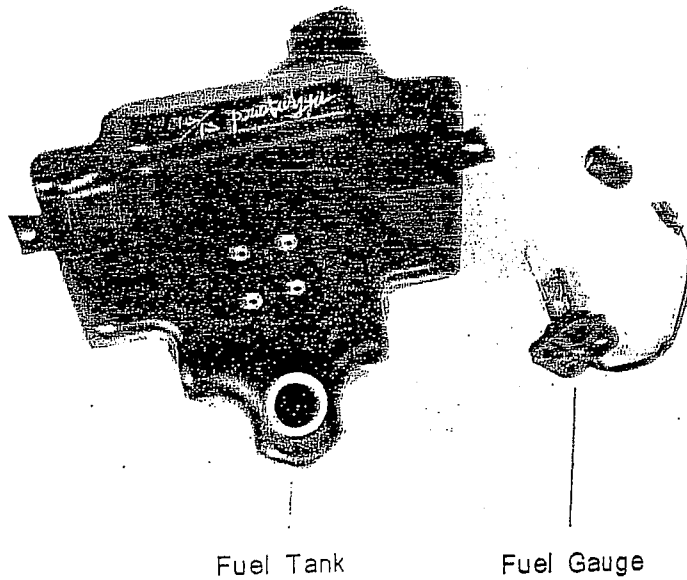

C. Dismantling and assembling the fuel tank

a. Remove the luggage box.

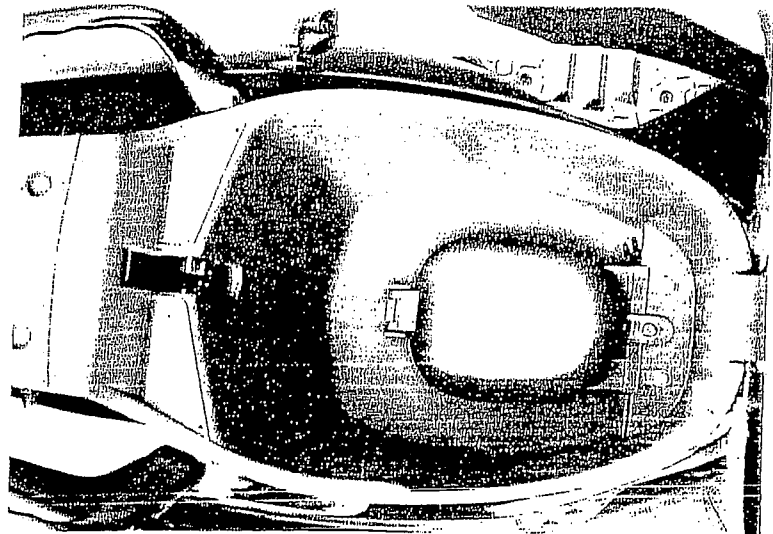

b. Remove the LH/RH handrails.

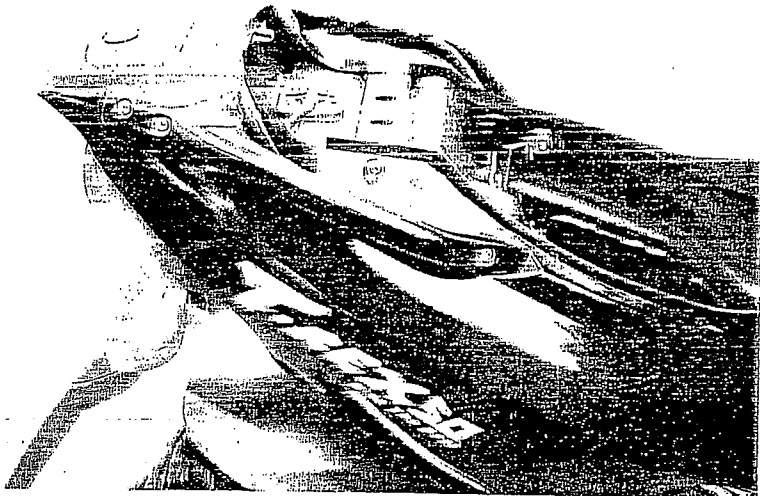

c. Remove the LH/RH body covers and the fuel tank cover.

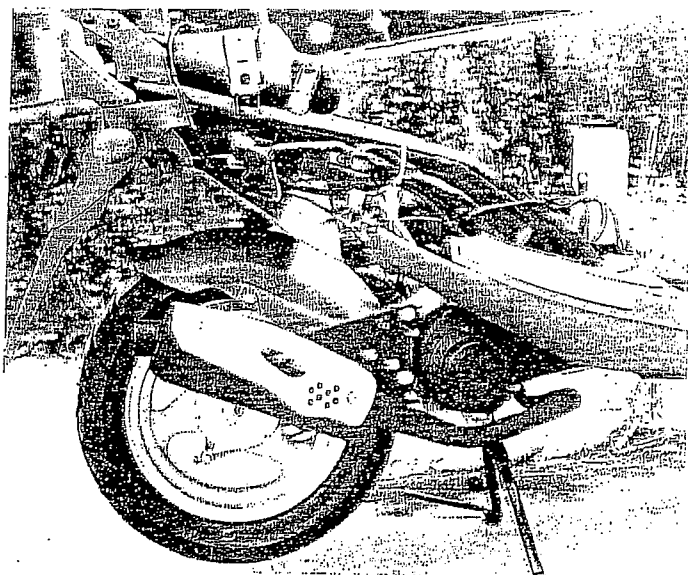

d. Remove the fuel tank fixing plate and the connecting wire of fuel tank gauge.

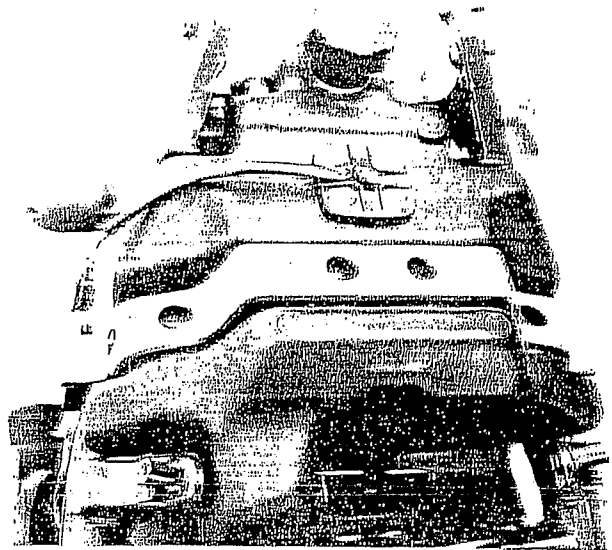

e. Remove the vacuum pipe and fuel pipe from the fuel tank and carburetor to drain off the fuel.  
f. Remove the fixing bolts from fuel tank.

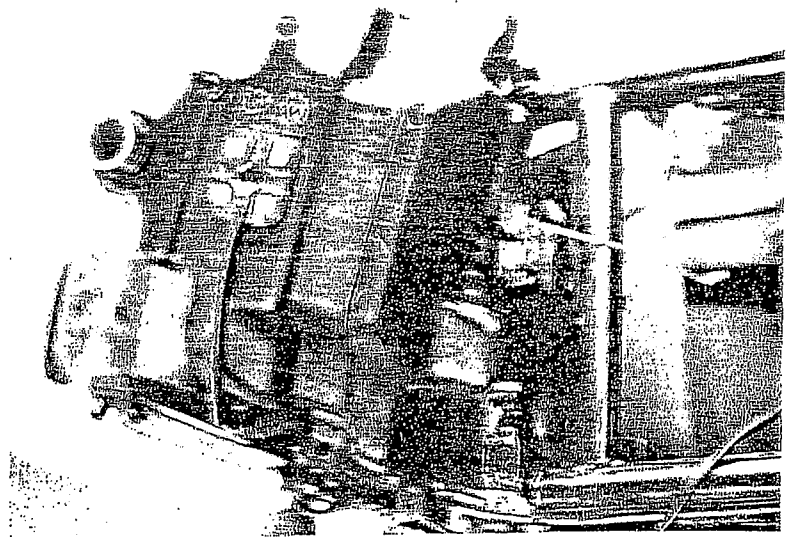

g. Remove the fuel tank.

h. To assemble the tanks, please reverse the dismantling procedures.  
M6: 1.0-1.2kg-m

D.Oil tank disassembling diagram:

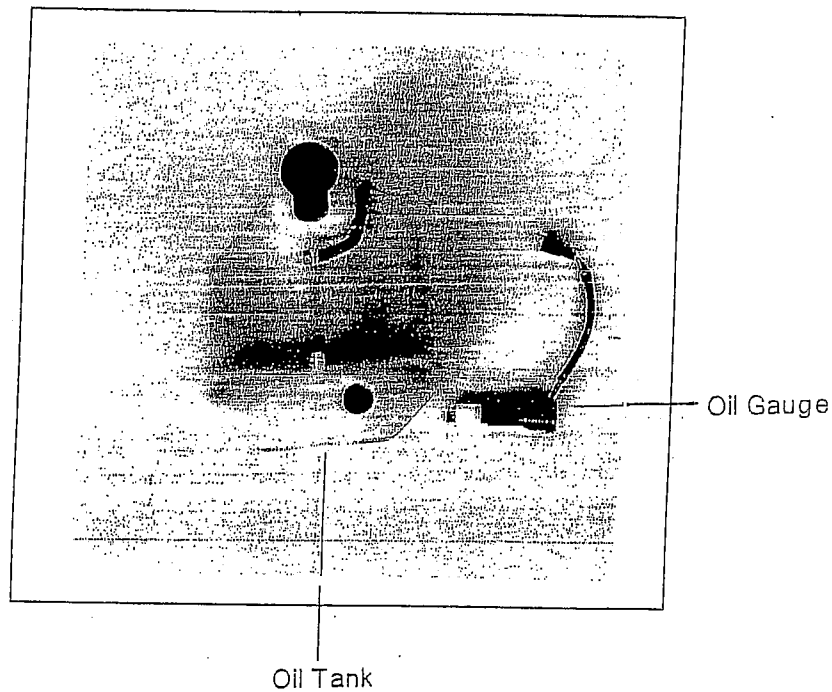

E.Dismantling and assembling the oil tank

- 1.Drain off the oil.
- 2.Disconnect plug of oil gauge.
- 3.Remove the oil tank.
- 4.Clean the oil tank.
- 5.To assemble the oil tank, please follow the opposite procedures of dismantling.

V. Electric equipment:	101
(1) Troubleshooting	101
(2) Battery	102
1. Check the specific gravity of eletrolyte	
2. Recharge	
3. Test the recharging performance	103
(3) Recharge system	104
1. The wiring diagram of recharge system	
2. Check A.C. flywheel magneto.	
3. Check the regulator/rectifier.	106
(4) Ignition system	
1. The wiring of ignition	
2. Check the spark plug	
3. Check H.V. cable and H.V. coil	
4. Check C.D.I. set	
(5) Starting system	
1. The wiring of starting	
2. Check the starter	
3. Dismantling the starting motor	
4. Check the starting motor	

## (1) Troubleshooting:

### A. Recharge system:

#### ● No power:

1. Battery over-discharging
  - ① No electrolyte in the battery.
  - ② Battery is bleached.
  - ③ Short circuit in the battery.
  - ④ Regulator malfunction
2. The battery wires are disconnected.
3. Fuse is broken.
4. Ignition switch is abnormal.

#### ● Voltage is too low:

1. Battery recharges insufficiently.
2. The bad connection on wiring system.
3. Recharge system is abnormal.
4. Regulator malfunction.

### B. Ignition system:

#### ● The sparking of spark plug is abnormal:

1. Spark plug is dead.
2. Wire connection is broken or short circuit.
  - ① between A.C. generator and CDI sets.
  - ② between CDI sets and High Voltage coil.
  - ③ between CDI sets and main switch.
  - ④ between main switch and spark plug.
3. Main switch is out of order.
4. H.V. coil is not in good function.
5. CDI sets is out of order.
6. A.C. generator is not in good function.

### C. Starting system:

#### ● Starting motor can't rotate:

1. The fuse is broken.
2. Battery recharges insufficiently.
3. Main switch is out of order.
4. Starting motor switch is out of order.
5. Front/rear brake switch is out of order.
6. Starter relay is out of order.
7. Wire disconnects or broken.
8. Starting motor is out of order.

#### ● Currency is unstable.

1. The wiring of battery connection is not good.
2. Ignition system connection is not good.
3. Ignition system is short circuit.
4. Lamp system connection is not good or short circuit.

### D. Abnormal recharge system:

1. The plug connection is not good. wire broken or short circuit.
2. Rectifier is out of order.
3. A.C. flywheel magneto is abnormal.

### E. Engine running unsmoothly:

#### 1. Ignition primary circuit.

① The wire or plug of wiring connection is not good.

② Main switch disconnects.

#### 2. Ignition secondary circuit.

① Ignition coil is not in good function.

② Spark plug is dead.

③ H.V. coil is not in good function.

④ The spark plug cap is not in good function.

#### 3. Ignition timing

① A.C. generator is out of order.

② A.C. coil is not in good function.

③ C.D.I. sets is out of order.

#### ● Starting motor runs weakly.

1. Battery recharges insufficiently.

2. Wiring system disconnects.

3. The alien objects drop in the motor or gear.

#### ● Starting motor can rotate, but engine can't start up.

1. Starting gear is abnormal.

2. Starting motor is reversedly rotating.

3. Battery is out of order.

## (2) Battery:

1. Check the specific gravity of electrolyte.

Always, remove the battery negative cable(-) first, then positive cable (+). But connect the positive cable (+) first, then connect the negative cable(-) when assembling.

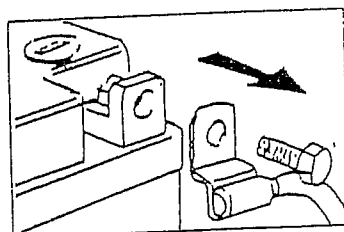
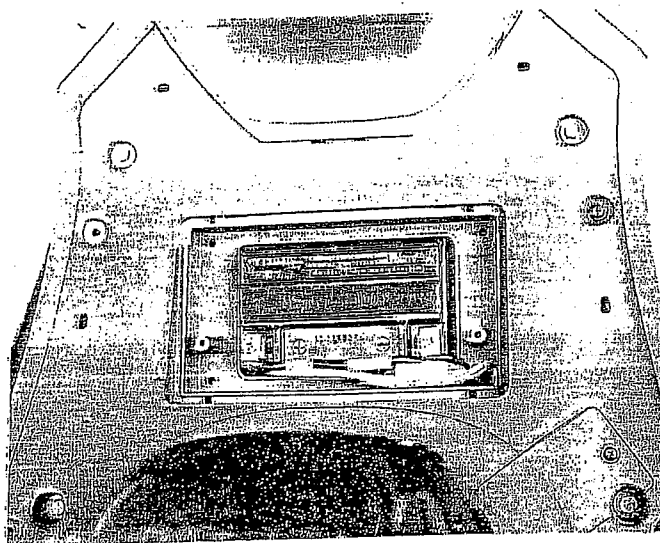
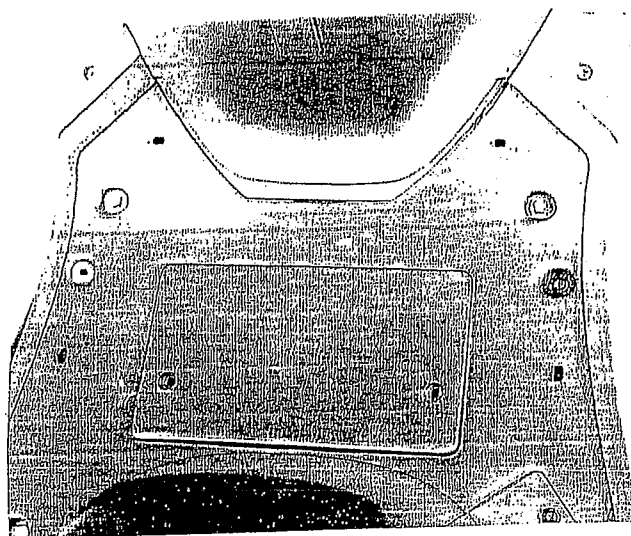

first remove  
negative cable(-)

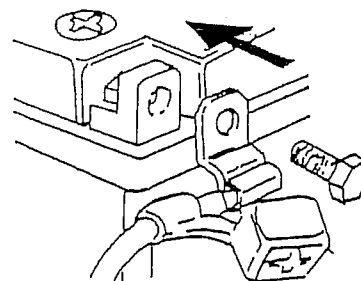

first connect positive  
cable(+)



## 2.Recharge

- Connection procedure:

connect the positive cable(+) of the negative cable(-) of the battery;and the negagive cable(-) of the recharger to the negative cable(-)of the battery.

- Recharging currency:

Please recharge(12V)according to the following currency and time.

Standard:

0.4A X 4-10Hr or Rapid:4A X 30min(50cc)

**NOTICE:**

This battery is totally sealed, Do not remove seal bolt when recharging.

**Notice:**

- Keep away from fire when recharging.
- The "ON" or "OFF" of recharging. currency must be operated by the switch of recharger. It will cause spark or explosive if plug or unplug the cable dirlectly.

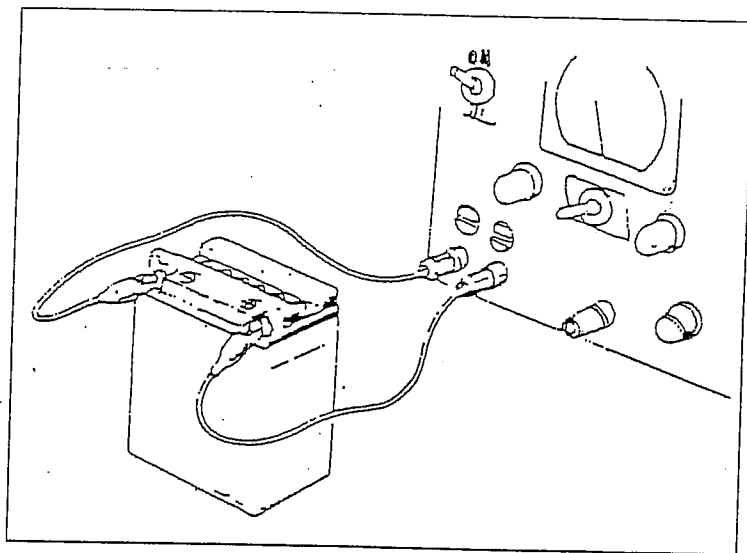

3. Test the recharging performance

- This test needs to be done when the battery is fully recharged.
- This test needs to be done after the engine is warm-up.

- a. Disconnect the orange cable of regulator.
- b. Open the fuse box, to remove the white cable.
- d. Connect currency meter between red/white cable and fuse.

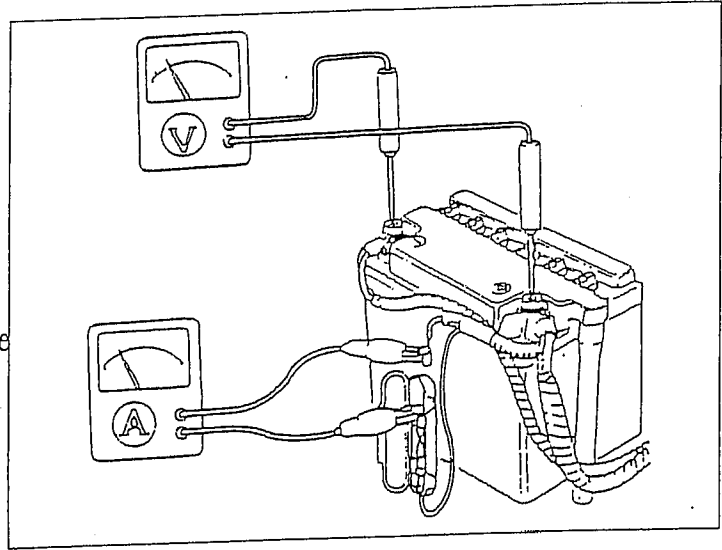

While testing, the red wire cable must not touch the frame.

- d. Set the head lamp switch at "OFF", engine revolution is at 2000 rpm while testing. Then increase the rpm slowly.

Head Lamp Switch	Recharging rpm	2,500rpm	6,000rpm
OFF(DAY)	Under 2,000rpm	Over 0.6A	1.5A(MIN)
ON(NIGHT)	Under 2,000rpm	0.6A(MIN)	1.5A(MIN)

- e. If the testing result does not match the standard value, check the regulator.

(3) Recharge system:

1. Recharge system diagram

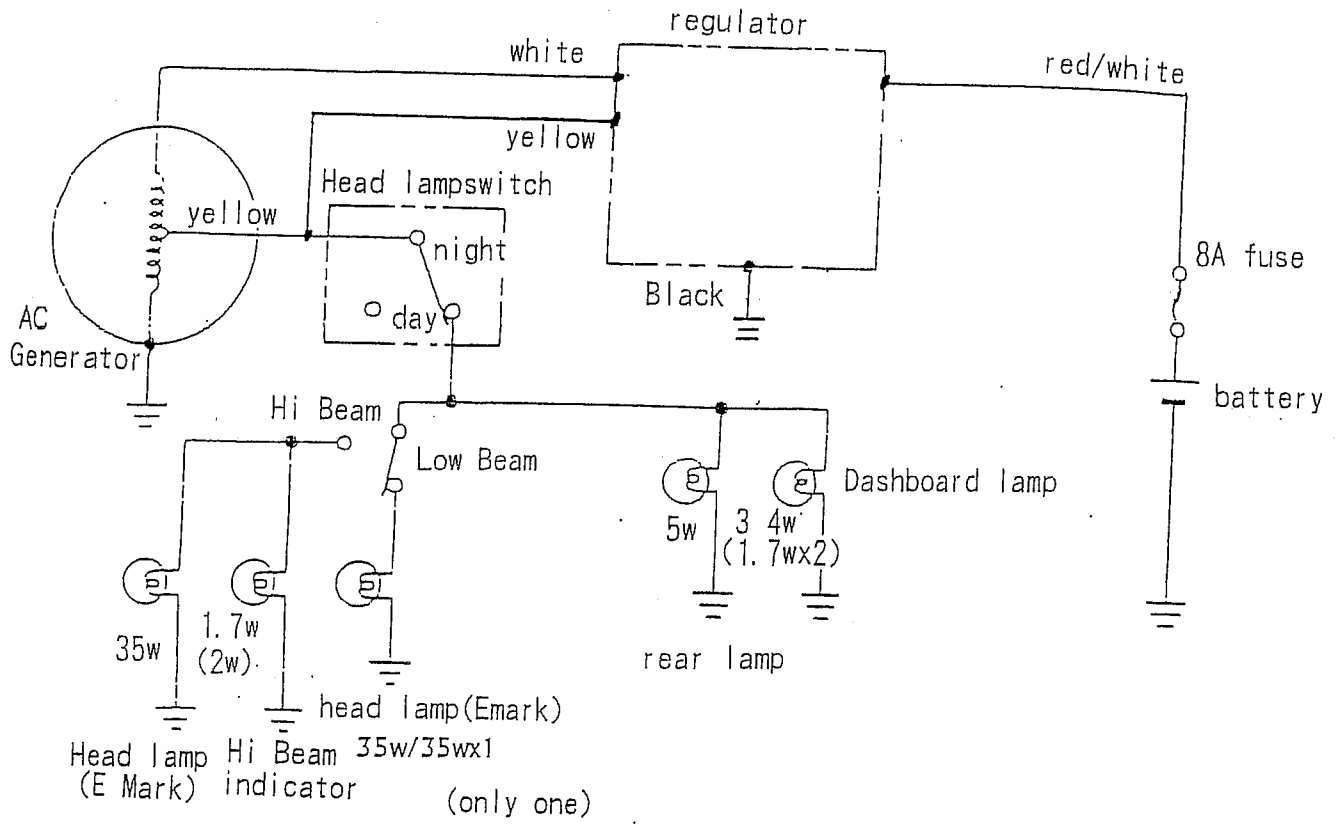

\*Head lamp without e-mark are 18w/18w.x2

## 2. Check A.C. Generator

- a. Open the seat cover and remove the luggage box.
- b. Measure the resistance value of terminals.

yellow/black 0.1-1.0
white /black 0.2-2.0

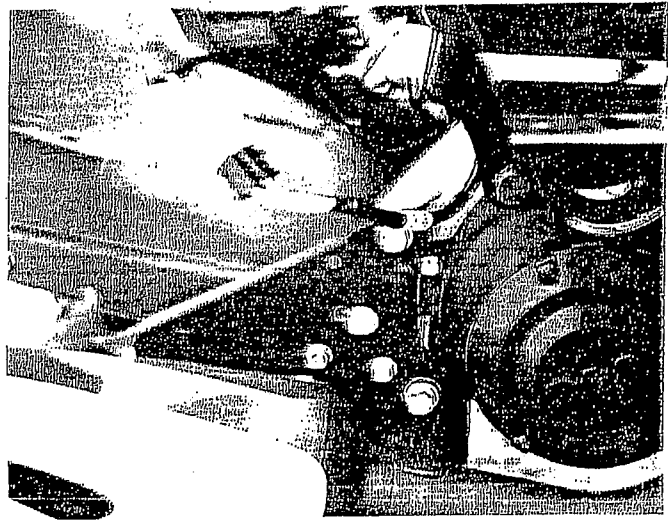

## 3. Check regulator

Measure the resistance value between each terminal.

It should be in the specified range, otherwise change a new one.

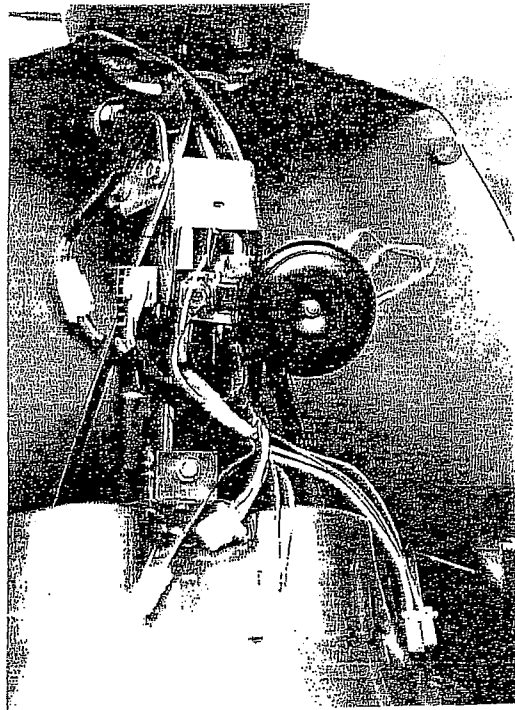

(4) Ignition system:

1. The wiring or ignition

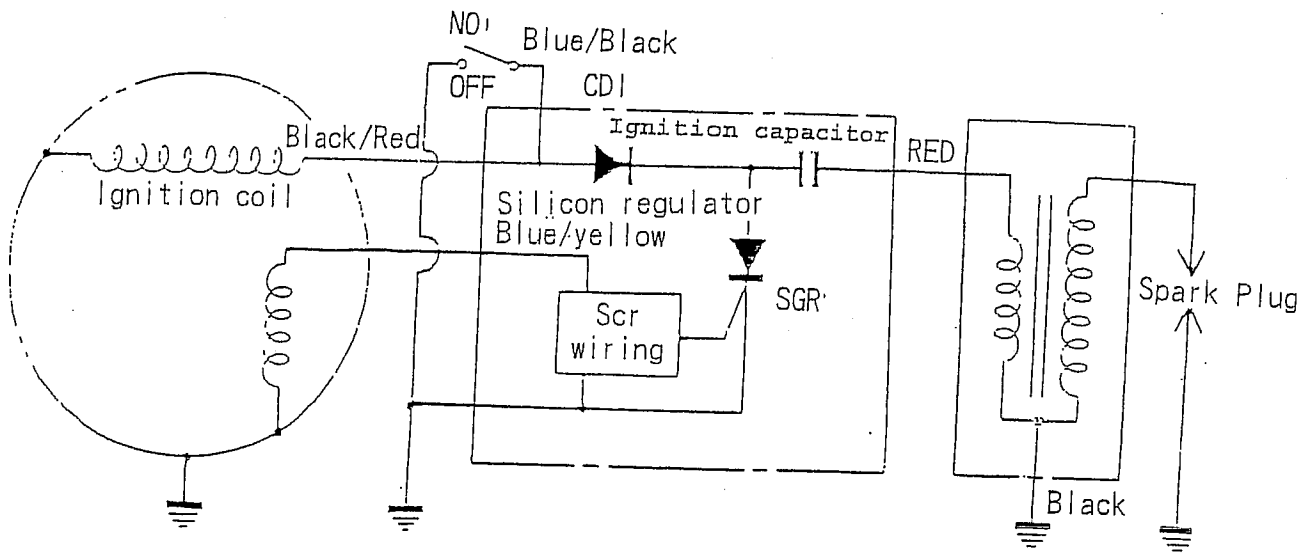

2. Check the spark plug.

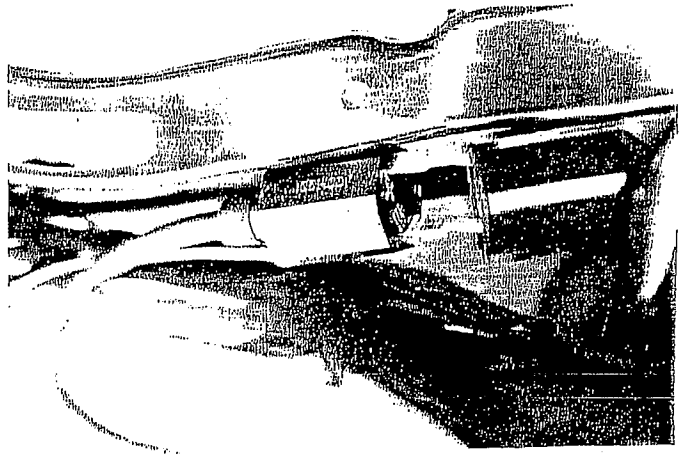

3. check the H.V. cable and H.V. coil by using the CDI tester. Please follow the instruction manual.

4. CDI sets checking.

Check with the CDI tester and please follow the instruction manual.

If the CDI test failed, please change a new one.

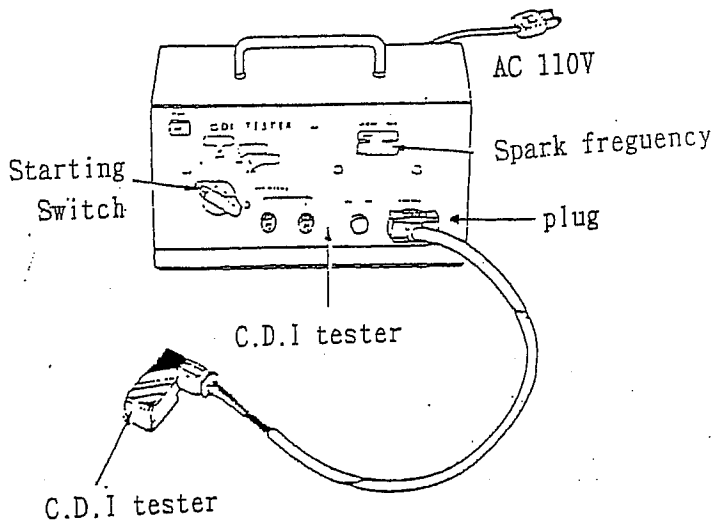
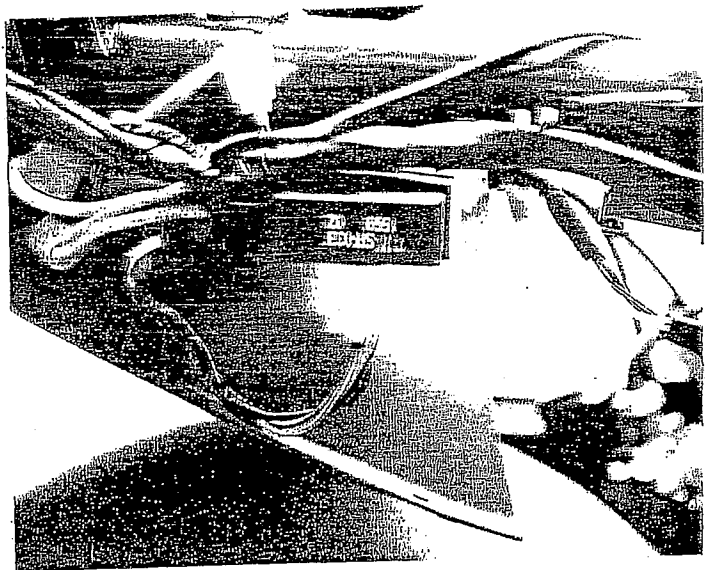

(5)The starting system:

1.The wiring of starting

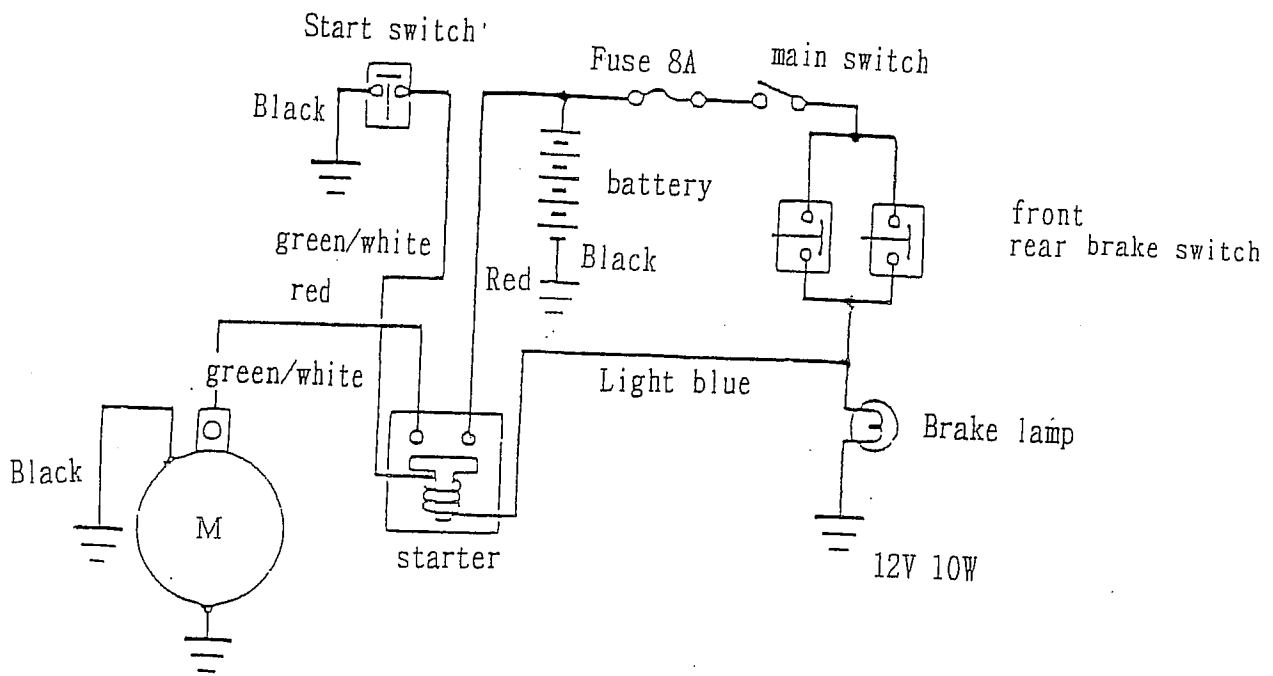

## 2. Check the starter

- Connect green/white cable to positive pole of battery, connect black cable of negative pole of battery. It means starter is function well if above connection and both Red Black cable of starting motor have currency passing through.

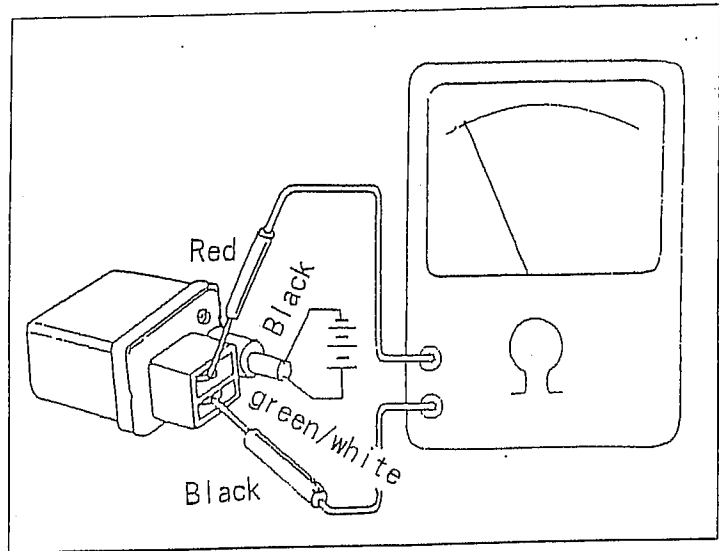

## 3. Dismantling the starting motor.

- Remove 2 screws on starting motor.
- Remove starting motor cables.

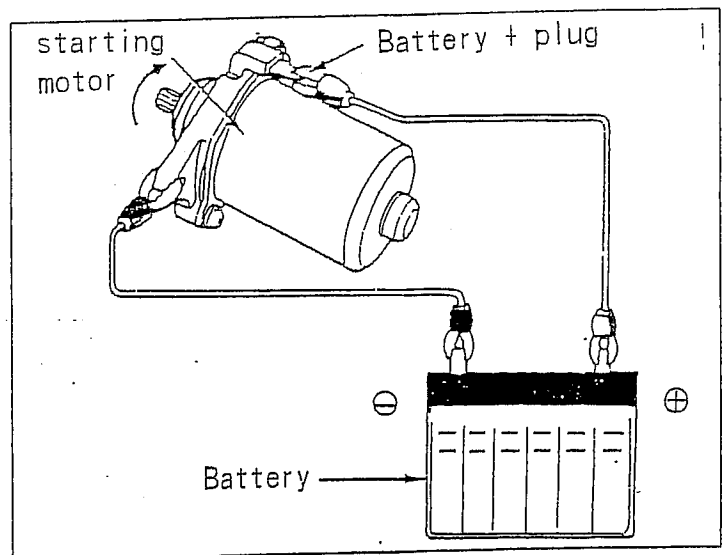

## 4. Checking the starting motor

Check the function by connecting the starting motor to battery.  
(Check if it is rotating counter clockwise)

Note: Do not operate starting motor for a longtime.



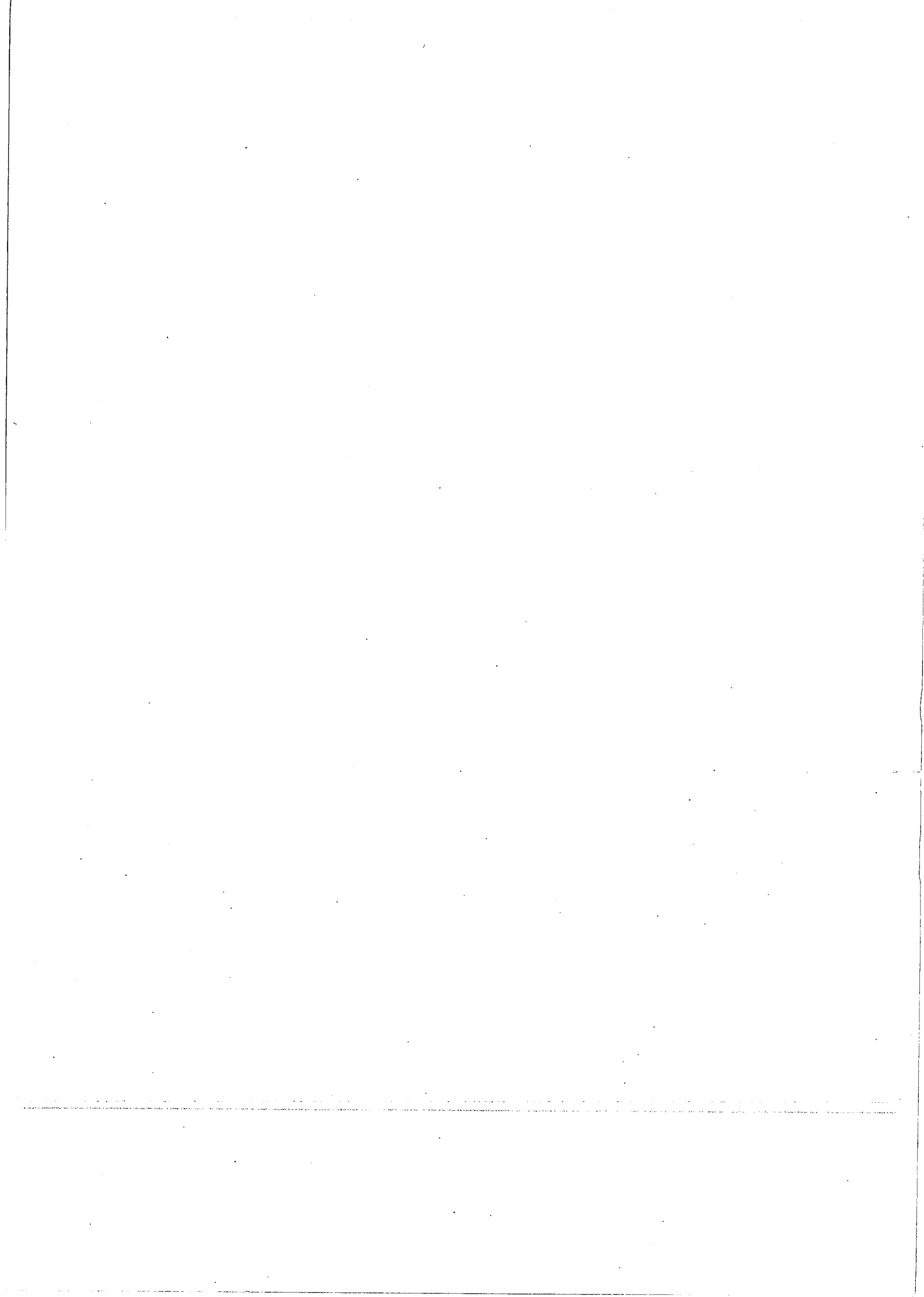



EXPORT OFFICE:

SOCIETE COMMERCIALE EURO-TAIWANAISE  
3RD FLOOR, NO.112 CHUNG SHAN N.RD.

SEC 2, TAIPEI, TAIWAN, R.O.C.

TEL: 886-2-25413253 FAX: 886-2-25367575

E-mail: eurotai@ms1.hinet.net

WEB SITE: <http://www.pgo.com.tw>

MANUFACTURED BY MPI (MOTIVE POWER INDUSTRY CO.,LTD.)  
AN ISO 9001 CERTIFICATED COMPANY

PART NO: C13510010001 SEP,1999.