

DEAR CUSTOMERS :

Thank you for buying **LIGERO** of **PGO** scooter. It is a fact that the efficiency and sustaining life of each scooter depend heavily on the operating method of each user. Thus this owner's manual will provide you a precise knowledge of easy adjusting, sustaining and precaution for your scooter. We hope you will read and check it carefully.

This manual includes **LIGERO** (front fender movable) & **LIGERO RS** (front fender fixed) models, and there are 3 kinds of engine displacement. PA50 is 2T Engine (50cc), PA100 is 4T Engine (100cc), PA125 is 4T Engine (125cc). Please recognize your scooter model clearly in order to read the following instruments.

If there is any question, please do not hesitate to ask your dealer for assistance.

CONTENT

| | | | |
|--|----|--|----|
| Warranty Card | 1 | Fuel | 21 |
| Scooter safety | 2 | Catalyst | 22 |
| Part location | 4 | Notation for operation and riding | 23 |
| Identification | 6 | Starting the engine | 23 |
| The function of switch & controller | 8 | Warming up the engine | 24 |
| Main switch | 8 | Brake operation | 25 |
| Speedometer | 9 | Engine initial run-in | 26 |
| Handlebar Controls | 11 | Parking vehicle | 27 |
| Steering Lock | 12 | Periodical maintenance | 28 |
| Seat Lock | 12 | Periodical maintenance table | 29 |
| Fuel Tank Cap | 13 | Exhaust control system | 32 |
| Kick Starter Lever | 13 | The air cleaner | 33 |
| Luggage Compartment | 14 | The spark plug | 34 |
| Pre-riding inspection | 15 | Brake adjustment | 35 |
| Rear Brake | 16 | Rear brake check | 35 |
| Front Brake | 16 | Front brake check | 36 |
| Brake Fluid | 17 | Brake fluid check | 36 |
| Throttle Grip | 18 | Front fork check | 37 |
| Engine Oil | 18 | Fuse replacement | 38 |
| Air Cleaner | 19 | Battery | 38 |
| Tire | 20 | Specification | 39 |
| Lamp & Signal Light | 21 | Wire diagram | 42 |
| Switches | 21 | Periodical maintenance record | 43 |



PGO Warranty Card

| | | | |
|---------|--------------------|------------|-------------------|
| Name | | Telephone | Registration date |
| Address | | | |
| Model | Displacement CC | Engine NO. | Vin NO. |

Customer Signature

Dealer Signature

SCOOTER SAFETY

▲WARNING

.Scooter riding requires special afford on your part to ensure your safety.

Know these requirements before you ride:

SAFE RIDING RULES

1. Always make a pre-ride inspection(page 13) and perform any needed adjustments or repairs before you ride the scooter.
2. Many accidents involve inexperienced riders. Most countries require a special scooter riding test or license. Make sure you are qualified before your ride.
NEVER lend your scooter to an inexperienced rider.
3. Many automobile/scooter accidents happen because the automobile driver does not "see" the motorcyclist. Make yourself conspicuous to help avoid the accident that wasn't your fault:
 - Wear bright or reflective clothing.
 - Don't ride in another motorist's "blind spot"
4. Obey all national and local laws and regulations.
 - Excessive speed is a factor in many accidents. Obey the speed limits, and NEVER travel faster than conditions warrant.
 - Signal before your make a turn or lane change. Your size and maneuverability can surprise other motorists.
 -

5. Don't let other motorists surprise you. Use extra caution at intersections , parking lot entrances and exits, and driveways.
6. Keep both hands on the handlebars and both feet on the floorboards while riding. A passenger should hold on to the scooter or the feet on then passenger foot pegs.
7. Never leave your scooter unattended with the engine running.
8. Moderate your speed when ridding over bumpy roads. Avoid hitting road hazards, such as sharp bumps and holes, in the road surface. These hazards can cause loss of control or structural damage to the vehicle.

Parts Name for Movable Model

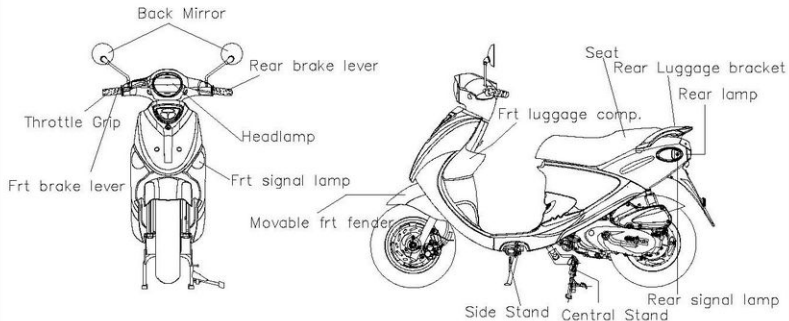

Remarks : The equipments depend on the actual vehicle.

Parts Name for Fixed Model

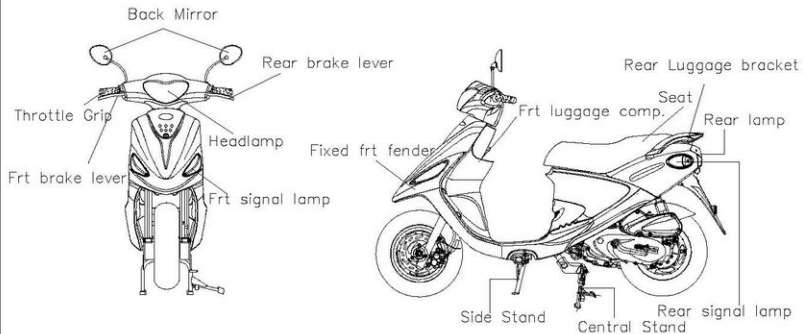

Reamarks : The equipments depend on the actual vehicle.

IDENTIFICATION

1.Engine No. is located (stamped) on the rear side of the left crankcase.



50 CC

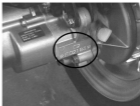

100 / 125 CC

NOTE:

The first 2 digital is model type, the others are production serial numbers.

Your dealer need this number for ordering the parts, please write down the engine no. for their reference.

2. Vehicle Identification Number (VIN) is located (stamped) inside the inner front cover.

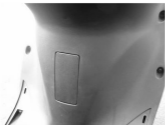

NOTE:

The first 9 digitals are model type, the last 8 digitals are production serial numbers.

Your dealer need this number for ordering the parts, please write down the engine no. for their reference.

THE FUNCTION OF SWITCHES

I. MAIN SWITCH

The main switch controls the ignition and lighting system, followings are the operation instruction.



The power is connected, engine can be started.
The key can not be pulled out at this position.



All the power is cut off. The key can be pulled out at this position.



All the power is cut off, and the handle bar is locked at this position.
Please refer to page for the detail operation instruction.

PUSH THE KEY AND TURN COUNTERCLOCKWISE

This operation can open the seat, no matter the key is at "ON" or "OFF" or "LOCK" position.



2.1 SPEEDOMETER

(2T Movable & Fixed model)

1.SIGNAL INDICATOR (GREEN)

When the blinker switch is shifted, this indicator will flash and tickling.

2.HIGH BEAM INDICATOR (BLUE)

When the HI/LO beam switch is set on 'HI', this indicator will light on

3.OIL WARNING INDICATOR

Fill the 2T oil as soon as this indicator lighting.

4.SPEED INDICATOR

5.FUEL GAUGE

The fuel gauge shows the approximate fuel supply available. At F (full) there are 6.3 liters approximately, including the reserve supply. When the meter pointer reaches to the first point of the red band, refill the tank as soon as possible.



2.2 SPEEDOMETER (Fixed 4T model)

1. SIGNAL INDICATOR (GREEN)

When the blinker switch is shifted, this indicator will flash and tickling.

2. HIGH BEAM INDICATOR (BLUE)

When the HI/LO beam switch is set on 'HI', this indicator will light on

3.SPEED INDICATOR

4.FUEL GAUGE

The fuel gauge shows the approximate fuel supply available. At F (full) there. are 6.3 liters approxattly, Including the reserve supply. When the meter pointer reaches to the first point of the red band, refill the tank as soon as possible.

5.Engine oil replacement indicator

When appear Red color, replace the 4T engine oil as soon as possible.

6.Insert the key to reset the engine oil replacement counter.

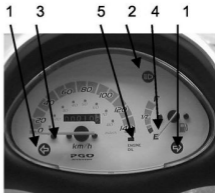

HANDLE-BAR CONTROLS

1.HI/LO BEAM SWITCH

HI-The high beam is on "≡D"

LO-The low beam is on "≧D"

2.Turn Signal Switch

Move to ← to signal a left turn, → to signal a right turn.

Press to turn signal off.

3.Horn Button

When the horn button is pressed, the horn will sound.

4.Starter Button

The starter button is below the headlight switch.

When the starter button is pressed, the starter motor cranks the engine.

5.HEADLIGHT Switch

ON-Headlight, position light, taillight and meter light will be on, when the engine is running.

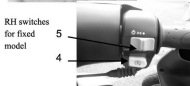
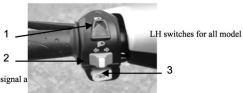

STEERING LOCK

To lock the steering, turn the handle all the way to left and turn the key from

"↔" to "⊗" Remove the key.



SEATLOCK

Push the key and turn counterclockwise to open the seat.



NOTE:

Do not turn the key to "⊗", while riding.
The scooter loss of control will occur.

FUEL TANK CAP

Insert the key into ignition switch. Push the key and turn counterclockwise to open the seat.

Then the cap can be opened.

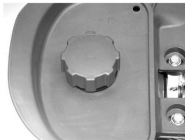

KICK STARTER LEVER

Swing the lever outwardly. Kick the lever down slowly till the gear stop, then kick the lever down strongly to star the engine.

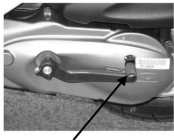

KICK STARTER

LUGGAGE COMPARTMENT

The luggage compartment is under the seat.

Maximum Weight limits: 5kg

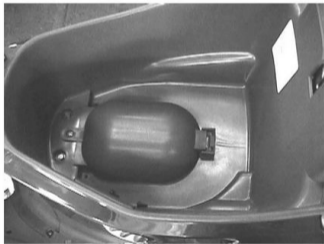

NOTE:

- 1.The max loading weight is 5 KGS.
- 2.If engine has been operating over a long time.
The luggage comp. become hot. Do not put luggage in the temperature.
- 3.Do not put important or fragile goods for security reason.
- 4.Raining or wash may cause luggage wet inside.
Please use water-resistant material for luggage wrapping.
- 5.Please lock the cover when leaving the scooter.

PRE-RIDING INSPECTION

Please do the inspection as following before riding:

| ITEM | PROCEDURE | PAGE |
|----------------------------|--|-------|
| FRONT BRAKE | Check the brake function, clearance , brake oil level, see if it is leaking. If necessary, may refill FMVSS DOT3(4) OR SAEJ 1703 brake oil. | 35-36 |
| REAR BRAKE | Check the brake function and clearance, proper adjustment if necessary. | 35 |
| THROTTLE GRIP | Check if it is smooth, put some lubricant . | 18 |
| LUBRICANT | Adjustments if necessary. Check the oil level/according to the request to refill oil. | 18 |
| TIRE | Check the pressure, the wear out situation. | 20 |
| CONTROLLER /GAUGE CABLE | Check if smooth operation. Add lubricant if necessary. | — |
| BRAKE LEVER (HANDLE) | Check if smooth operation. Add lubricant if necessary. | 16 |
| CENTRAL STAND | Check if smooth operation. Add lubricant if necessary. | — |
| ASSEMBLY /FITTING | Check all the assembling parts, fixing & adjusting if necessary. | — |
| FUEL TANK | Check the fuel level. Refill up if necessary. | 21 |
| LAMP /SIGNAL LIGHTS | Check if it is operating good condition. | 21 |

BRAKE

Adjustment:

1. Measure the distance of the rear brake lever play before the brake starts to take hold.

Free play should be: 10-20mm

2. Make free play adjustments by turning the adjusting nut at the brake arm.

Make sure the contact on the adjusting nut is seated on the brake arm pin after making final free play adjustment.

3. Apply the brake several times and check for free wheel rotation when released.

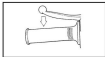

FRONT BRAKE

The front brake will be on function when hold the handle and pull the right hand lever.



NOTE:

If the pre-riding inspection is not performed, severe personal injury or vehicle damage may result. Inspect your scooter, and perform any needed adjustments or repairs. Every day before you ride it. The items listed above will only take a few minutes to check and, in the long run, can save time, expense, and possible your life.

BRAKE (Please refer to page35)

1.Front /Rear brake levers

Inspect the free play of levers. Make sure the function is well.

Please check the brake at low speed, adjust the free play if it is not correct.

CAUTION

If the brake lever feels soft when operating, Which means the brake system has problem. Do not ride the scooter before the problem is ruled out.

2.BRAKE FLUID (Disk Brake)

Check the fluid level. Refill it if necessary.
Fluid Spec. FMVSS DOT 3 or SAE J1703

3.DISK BRAKE PAD

Please refer to page 36. Please go to the PGO Dealer when this brake needed repairing.

BRAKE FLUID LEAKAGE INSPECTION

Hold the brake level for few minutes to check if there is any fluid leaks from the hose connector or main cylinder.



CAUTION

Go to the PGO dealer immediately when find the brake fluid is leaking. The leakage means the braking system has deadly dangerous problem.

THROTTLE GRIP

- Turn the grip and check the clearance & operation situation.
- Make sure the grip will automatically return to the original position.
- Ask your dealers for adjusting advice if necessary.



ENGINE OIL

1. 4T Engine (100 / 125 CC)

- Engine oil volume must be examined after engine warm-up 2-3 min. Be sure to execute on flat road.
- Draw out and examine the oil gauge. Please refill if the volume below the low warning line.



2. 2T Engine (50 cc)

- Add the 2T engine oil into the oil tank.



AIR-CLEANER

The air filter will keep dust away from the engine and also protect it against wearing out. Please ask the dealer to check & clean the filter periodically, or by yourself.
(ref:page 33)

1. 4T Engine (100 / 125 CC)

Wet paper filter element



2. 2T Engine (50 CC)

Sponge filter element

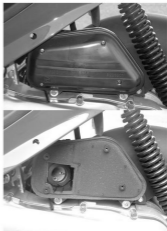

TIRE

To secure the best performance & extend life-span, please pay your attention to the following:

1.TIRE PRESSURE

Be sure that tire pressure is accordance with the standard pressure.

NOTE:

The inside temperature of tire must be even to outside or else pressure need to be adjusted. Besides the factor of loading, weight even cruising speed should take into consideration before adjusting.

The normal tire pressure:

Front: 1.5kg/cm²

Rear: 1.75kg/cm²

2.SIMPLE CHECK:

Check the tire appearance before riding. Please ask your dealer for repairing or replacing if the appearance has been detected significant worn out or stabbed by nails, or glass.

3.INSPECTION FOR THE DEPTH OF THE TIRE GROOVE:

The appearance will become slippery due to significant worn out dusty or wet road riding. Please replace the tire if the depth is less than 0.8mm, see the following picture for reference.



LAMPS & SIGNAL LIGHTS

Make sure the front lamp, rear lamp, brake lamp, turn signal lamp, tail lamp and all other indicator lights working well.

SWITCHES

Make sure the switch of head lamp, turn signal lamp, brake lamp , horn, start button, and over take lamp working well.

FUEL

Be sure sufficient fuel in tank.

Tank capacity: 6.3 L

CAUTION:

1. Please fill the unleaded gas if your scooter is equipped with catalyster.
2. Do not fill up the gas over the neck of gas entrance , otherwise it will be spilling out due to the hot temperature.
3. It may cause inflammable if gas is split onto the engine or muffler.

CATALYSTER (OPTIONAL DEVICE)

Catalyst device is designed for decreasing air pollution from exhaust system and it is mounted inside the muffler.



1. Make sure to park your scooter away from flammable material, pedestrian or child to avoid danger due to yielding hot from muffler cover.
2. Don't try to use any fuel if it is not unleaded gas.
3. Don't try to turn off the main switch when riding.
4. Don't try to ride, idle or stop on the surface of inflammable.
5. Please keep your engine in good function all the time, otherwise high temperature will yield from catalyst device due to short circuit ignition, or fuel system working abnormal.
6. Please periodically maintain your scooter to ensure exhaust control system and catalyst device working well.

NOTATION FOR OPERATION & RIDING

1. Please make sure you are familiar with all the operation system & function before riding. Please contact with your dealers if there's any question.
2. Do not start the engine in a closed place due to potential gas, threat from poisonous exhaust amassed.
3. Please be noted the side stand must be withdrawn from the ground before riding, otherwise dangerous situation may occur due to your ignore.



STARTING ENGINE

1. Turn the main switch to 
2. When the throttle is totally loosed, hold the brake lever and push the start button, or use the kick starter to start the engine.

CAUTION:

If the engine can't be started, you should loose the start button to avoid losing significant electric power. Please do not push the button over 5 seconds per each time. Try kick starter to start the engine if the start button is not working properly.

WARMING UP THE ENGINE

To protect the engine, please warm up the engine 1~3 minutes before riding. Do not immediately accelerate when the engine is cold.

NOTE:

Please read the instruction "engine initial run-in" page26-before initial riding.



● Scooter riding(after warming up the engine):

1. Hold the brake lever and push down the central stand.
2. Adjust the angle of rear view mirrors within visible field.
3. Try the function of signal light before riding.
4. Turn the throttle grip gradually then close the signal light during riding.

● Accelerating(throttling):

Use the throttle grip control your cruise turning it to wards your side will speed up, and reversing it will slow down.



BRAKE OPERATION

1. Release the throttle grip.
2. Press front and rear brake levers gradually.

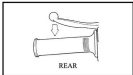
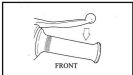

NOTE:

1. Sudden stop will cause sliding or falling down.
2. Use the braking carefully while you are turning, improper use of brake may cause sliding.
3. Slow down the speed when riding on the iron plate, railway track, wet road.
4. Braking on the wet road is difficult.
5. Slow down the speed when sloping down.

ENGINE INITIAL RUN-IN

0~1,000 KMS riding will be the critical period regarding scooter life span. The new engine can't afford too much loading during the first 1,000kms. Every part of the engine will be run-in to obtain the correct clearance in this period. Be sure to avoid prolonging the throttling out totally or any operation causing high temperature in the engine. Please read careful the following information.

1. 0~150KM

Avoid over 1/2 throttling operation. Cool down the engine 5-10 min/ hour. Do not cruise by constant speed for riding.

2. 150~500KM

Avoid over 1/2 throttling operation for long riding.

3. 500~1,000KM

Avoid over 3/4 throttling operation.

NOTE:

Change gear & engine oil (4T engine) after 300 KMS.

4. OVER 1,000 KM

Avoid full throttling in a long riding.

NOTE:

Please contact your dealers if any problem takes place during above periods.



CORRECT



INCORRECT



INCORRECT

PARKING:

Turn off the engine and pull out the key when parking the scooter.

NOTE:

Please park your scooter away from the child & pedestrians if the muffler is hot. Do not park your scooter on a slope or soft ground to avoid falling down.

PERIODICAL MAINTENANCE

To secure the most safe & effective performance, please check, adjust and lubricate your scooter periodically. Periodical maintenance and lubrication should be acknowledge as an important instruction. Meanwhile, please pay your attention to the environment, climate, geography and riding status in order to set up a proper maintenance interval.

NOTE:

This scooter is designed to be riding on normal paved road. If under a dirt & wet condition, please clean the air-cleaner frequently, otherwise the engine will be worn out quickly.

If you are not familiar with the inspection & maintenance, please contact to your dealers.

PERIODICAL MAINTENANCE TABLE

In order to achieve safe riding, good performance and reduce pollution, please execute the recommended maintenance accordingly.

| Item | Model 2T or 4T | Checking Content | MONTHS/DISTANCE(IN KM)FOR CHECKING | | | | | | |
|---|-------------------|---|------------------------------------|---|---------------|---------------|-----------------|-----------------|-----------------|
| | | | 1 or 300 km | 3 or 2500k | 6 or 5000k | 9 or 7500k | 12 or 10000k | 15 or 12500k | 18 or 15000k |
| Engine oil | 2T | Add | According to Oil warning light | | | | | | |
| Engine oil* | 4T | Replace (800cc, total 900cc) | ○ | Replace it per 1000km | | | | | |
| Oil Filter | ALL | Replace | ○ | Clean it per 5000km or replace it if required | | | | | |
| Coarse oil filter* (on oil draining bolt) | 4T | Clean or replace it if necessary | ○ | Clean it per 3000km or replace it if required | | | | | |
| Air cleaner | ALL | Clean or replace it if necessary | | ○ | ○ | ○ | ○ | ○ | ○ |
| Air filter | ALL | Clean or replace it if required | | ○ | ○ | ○ | ○ | ○ | ○ |
| Gear oil* | ALL | Replace (90cc, total 110 cc) | ○ | ○ | | ○ | | ○ | |
| Disk & drum brake | ALL | Leaking and function check | | ○ | ○ | ○ | ○ | ○ | ○ |
| Clutch shoes* | ALL | Check or replace it if necessary | | ○ | ○ | ○ | ○ | ○ | ○ |
| Rear brake arm | ALL | Function check and adjustment | | | ○ | | ○ | | ○ |
| Tires | ALL | Worn-out check or replace it if necessary | | ○ | ○ | ○ | ○ | ○ | ○ |
| Wheel bearing* | ALL | Fasten tightly if loosen | | ○ | ○ | ○ | ○ | ○ | ○ |
| Front fork* | ALL | Leaking and function check | ○ | ○ | ○ | ○ | ○ | ○ | ○ |
| Steering head bearing* | ALL | Check looseness. Adjust it if required | | | ○ | | ○ | | ○ |

NOTE : 1.Items with “*” mark indicate our recommendation to have it done by PGO dealer.

| Item | Model 2T or 4T | Checking Content | MONTHS/DISTANCE(IN KM)FOR CHECKING | | | | | | |
|---------------------------------|-------------------|---|------------------------------------|---------------|---------------|---------------|-----------------|-----------------|-----------------|
| | | | 1 or 300 km | 3 or 2500k | 6 or 5000k | 9 or 7500k | 12 or 10000k | 15 or 12500k | 18 or 15000k |
| Rear absorber* | ALL | Leaking and function check | ○ | ○ | | ○ | | ○ | |
| Main/Side Stand | ALL | Function check or replace it if required | ○ | ○ | ○ | ○ | ○ | ○ | ○ |
| Nuts, bolts, fasteners | ALL | Tighten it if required | ○ | ○ | ○ | ○ | ○ | ○ | ○ |
| Battery | ALL | Make sure that the voltage stayed over 12.8V. Recharge the battery it required. Clear the poles. | | ○ | ○ | ○ | ○ | ○ | ○ |
| | | | | ○ | ○ | ○ | ○ | ○ | ○ |
| Valve gap* | 4T | Check and adjust when engine is cool (0.08mm for IN & EX) | Adjust it when necessary | | | | | | |
| Carbon cleaning * | 2T | Clean combustion carbon when engine output reduced | | | ○ | | ○ | | ○ |
| Spark plug* | ALL | Clear or replace if required | | ○ | ○ | ○ | ○ | ○ | ○ |
| V belt* | ALL | Worn out check or replace if necessary. | | | ○ | A | ○ | A | ○ |
| Fuel feeding system* | ALL | Crack and blockage check. Replace it if necessary. | | | ○ | | ○ | | ○ |
| Engine idle speed* | ALL | 2T engine: 1900±100 rpm 4T engine: 1700±100 rpm | ○ | ○ | ○ | ○ | ○ | ○ | ○ |
| Carburetor idle A/F Adjustment* | ALL | Check and adjust referring to CO/HC Percentage. | ○ | ○ | ○ | ○ | ○ | ○ | ○ |

NOTE :

1. Items with “*” mark indicate our recommendation to have it done by PGO dealer.
2. “A” denotes that function check or replace it when the engine performance reduces significantly.

NOTE 1 :

For 4T engine, the engine oil shall be changed completely after run-in period 300km or one month later.
This can make sure the engine runs smoothly.

NOTE 2 :

The exchange of brake fluid

1. After disassembling of brake main cylinder or caliper, do change the new fluid.
2. Check the fluid level often, Refill if necessary.
3. Change the oil seal of main cylinder and caliper every two years.
4. Change the brake fluid hose every four years.

Exhaust control system (only be valid for the bike equipped catalyst):

1. Catalyser will not be possible to be withdrawn individual, the only you have to do is to maintain fuel, ignition, intake/exhaust system periodically.
1. Maintenance procedure of air clearer (see page 33).
2. Spark plug's checking: please repair or replace if spark plug is dirty.
3. Fuel system's checking: please repair or replace if fuel pipe is jammed or broken.
4. Muffler's checking: please fix tightly once or renew a gasket if it is leaking.
5. Idle rpm's checking: please fix tightly once or renew a gasket if throttle cable.
6. Exhaust density checking while idle: please left the job to any service center of anti-pollution inspection for carburetor adjusting.

THE AIR-CLEANER

4T Engine(100/125 cc)

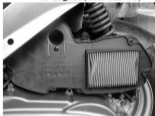

2T Engine (50 cc)

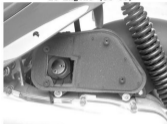

If there is too much accumulation of dust inside the air cleaner, it will reduce the output of engine performance and cause abnormal consumption of fuel.

Procedures of changing the air element:

1. Take off the cover of filter.
2. Draw the core of filter.
3. Clean and dry by air compressor, then spray with 5 grams motor oil (SAE10W30) approximately or replace it if necessary.
4. Put the cover back carefully to make sure fitted to the cover without leakage.

NOTE : Please do not start the engine before the air-cleaner is assembled, otherwise the piston & main case will be badly worn out.

THE SPARK PLUG

Spark plug is one of the important parts of the engine and it is easy to be checked. According to spark plug condition, you may infer the situation of the engine. The ideal color of the electrode should be light brown. If there's any problem, please ask your dealers to check will be corroded & worn out due to the hotness and dirt for the time being. If happened, please change a new spark plug.

- Standard spark plug: For 4T Engine C7HSA(NGK) ; CR7HSA for EEC specification
For 2T Engine BP7HS(NGK) ; BPR7HS for EEC specification
- Spark plug gap : 0.6~0.7mm

When checking the spark plug, please cleaning the surface of the washer and screw, the fasten it.

- Toroue: 1.2kgf-m

NOTE:

If there is no wrench or torque gauge can be used, please wrenching it by your fingers turn 1/4~1/2 and later use the wrench to fix it to the standard torque once available.

EXCHANGE OF GEAR OIL

- Please change the oil after first 300km ride, then it is recommended to change the gear oil every 2500~3000km.
- Regular changing volume : 90 c.c. (SAE 140)



BRAKE ADJUSTMENT

The clearance of lever

- (a) Front brake: 10~20 mm
- (b) Rear brake: 10~20 mm

NOTE:

Please contact to PGO dealer if the clearance is incorrect.

Rear brake check

The indicator will help you to easily screen the status of brake function. Please replace the shoe of rear brake if indicator reaches the warning line.

- 1. Brake indicator
- 2. Warning line



Front brake check

Please acting the brake for checking. If the indicator almost reach the disk, please ask your dealers to change it.

1. Inspection hole cover
2. Indicator
3. Brake disk
4. Brake pad

NOTE: Please be sure to put the cover back and fasten. If the brake area is wet(getting water), the brake will be out of order and jeopardizing you.

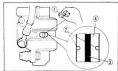

BRAKE FLUID CHECK

Insufficient brake fluid will make the air into the brake system and may cause the brake out of control. Please check the brake fluid level all the time and refill it if necessary.

1. When checking the oil level, please turn the handle bar assuring the brake oil on the horizontal position.
2. Use correct brake oil, otherwise the oil seal will be defected. This will cause the oil leaking & losing the brake function. Standard brake oil: FMVSS DOT3 or SAE J1703.
3. Refill same kind of brake oil. Mixing with different oils will yield a bad reaction and cause the brake out of order.



1. LOWER LEVEL

- 4.To avoid the water getting into the main cylinder, otherwise the boiling temperature of the brake oil will be declining make the air be obstructed.
- 5.Brake oil could reode the painting surface and plastic parts. If any oil were spilled out, please clean it immediately.
- 6.If the brake oil can't be refilled to the standard level, please check with your dealers.

FRONT FORK CHECK

NOTE:

In order to avoid falling down, please park you scooter firmly will be safe.

1.Eyes checking:

If any scratched, broken or leaking inside the pipe by vision.

2.Function check:

Park the scooter on flat place.

- (A) Hold the handle and keep the scooter in vertical position, and then hold the front brake lever.
- (B) Move up & down the front fork for several times.

NOTE:

If found the front fork is not smooth or broke, please contact your dealers.



2.FUNCTION CHECK

FUSE REPLACEMENT

1. The fuse is located beside the battery.
2. Take off front cover by loosening two screws.
3. If the fuse is burned out, turn off the main switch and related switches, replace a correct fuse, then turn on and check the circuit function, please contact with your dealers if the problem remains.

NOTE:

Do not use a higher ampere fuse than the standard one. A different (abnormal) fuse will damage circuit system and may cause fire.

BATTERY

The battery is in free-maintenance type (MF), so it won't be necessary to check or refill the liquid. If the liquid is leaking, please contact with your dealers A.S.A.P.

NOTE:

Please do not try to take off the sealed rubber even when charging the battery , that will damage your battery.

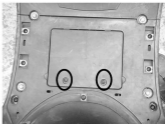

SPECIFICATIONS

| TYPE | PA-50 | PA-100 | PA-125 |
|--------------------|--------------------|--------------------|--------------------|
| DIMENSION | | | |
| overall length | 1710mm | 1710mm | 1710mm |
| overall width | 645mm | 645mm | 645mm |
| overall height | 1060mm | 1060mm | 1060mm |
| axles distance | 1210 mm | 1210 mm | 1210 mm |
| DRY WEIGHT | 100KG | 98KG | 101KG |
| ENGINE | | | |
| type | 2 stroke | 4stroke | 4stroke |
| model no. | P5 | C3 | C2 |
| cooling | forced air cooling | forced air cooling | forced air cooling |
| cylinder array | single | single | single |
| displacement | 49 c.c | 101 c.c | 124.9 c.c |
| start system | electric and kick | electric and kick | electric and kick |
| lubrication system | separated pump | compress spray | compress spray |
| lubricant | SAE30 (FC class) | SAE15W40 | SAE15W40 |
| capacity | 1.0 L | 0.9 L | 0.9 L |
| spark plug | BP7HS(NGK) | C7HSA(NGK) | C7HSA(NGK) |
| clutch type | DRY TYPE CVT | DRY TYPE CVT | DRY TYPE CVT |
| gear shift type | AUTOMATIC (V BELT) | AUTOMATIC (V BELT) | AUTOMATIC (V BELT) |

SPECIFICATIONS

| TYPE | PA-50 | PA-100 | PA-125 |
|---|--------------------------------|--------------------------------|--------------------------------|
| GEAR OIL model min. volume total volume | SAE 140 90cc 110cc | SAE 140 90cc 110cc | SAE 140 90cc 110cc |
| AIR CLEANER | SPONGE | DRY FILTER | DRY FILTER |
| FUEL: gasoline capacity of tank | UNLEADED ONLY 6.3L | UNLEADED ONLY 6.3L | UNLEADED ONLY 6.3L |
| TIRE size (front) (rear) | 90/90-10 90/90-10 | 3.50-10 3.50-10 | 3.50-10 3.50-10 |
| ELECTRIC SYSTEM ignition system generator system | C.D.I AC FLYWHEEL MAGNET | C.D.I AC FLYWHEEL MAGNET | C.D.I AC FLYWHEEL MAGNET |
| BATTERY TYPE capacity | YTX4L-BS 12V 3AH | YTX7L-BS 12V 6AH | YTX7L-BS 12V 6AH |

SPECIFICATIONS

| TYPE | PA-50 | PA-100 | PA-125 |
|----------------------------------|-------------------|-------------------|-------------------|
| BULB VOL / WATT * Q'TY | | | |
| head lamp(HI /LO)movable | 12V 35W / 30W * 1 | 12V 35W / 30W * 1 | 12V 35W / 30W * 1 |
| head lamp(HI/LO)fixed | 12V 35W/35W * 1 | 12V 35W/35W * 1 | 12V 35W/35W * 1 |
| rear lamp / | 12V 5W / | 12V 5W / | 12V 5W / |
| stop lamp | 21W * 1 | 21W * 1 | 21W * 1 |
| signal light | 12V 10W * 4 | 12V 10W * 4 | 12V 10W * 4 |
| speedometer indicator | 12V 1.7W * 2 | 12V 1.7W * 2 | 12V 1.7W * 2 |
| high beam indicator | 12V 1.7W * 1 | 12V 1.7W * 1 | 12V 1.7W * 1 |
| signal indicator | 12V 1.7W * 2 | 12V 1.7W * 2 | 12V 1.7W * 2 |
| oil warning indicator | 12V 1.7W * 1 | NA | NA |

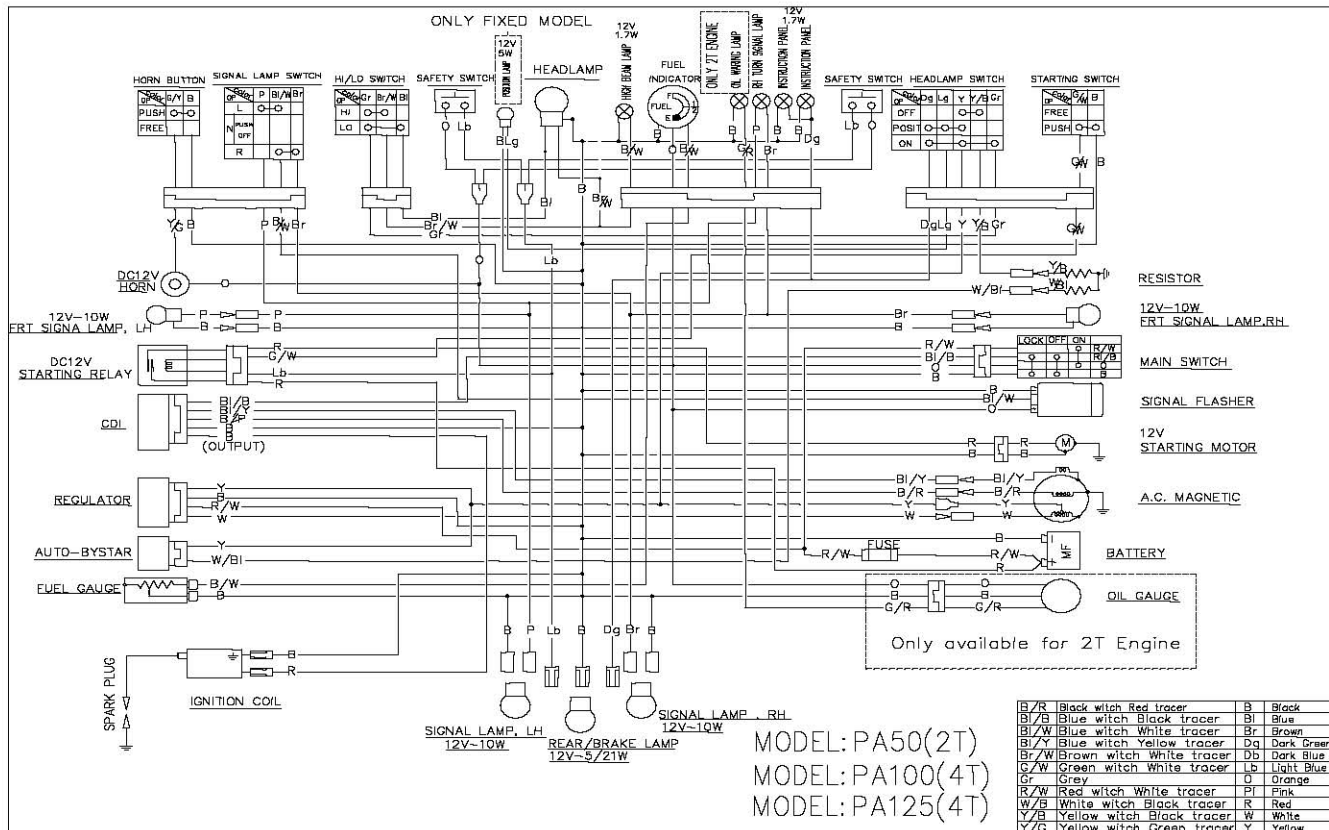

Periodic Maintenance Record

| Plan km | Actual km | Date | Dealer Sign. | Plan km | Actual km | Date | Dealer Sign. |
|---------|-----------|------|--------------|---------|-----------|------|--------------|
| 300 | | | | 14,000 | | | |
| 1,000 | | | | 15,000 | | | |
| 2,000 | | | | 16,000 | | | |
| 3,000 | | | | 17,000 | | | |
| 4,000 | | | | 18,000 | | | |
| 5,000 | | | | 19,000 | | | |
| 6,000 | | | | 20,000 | | | |
| 7,000 | | | | 21,000 | | | |
| 8,000 | | | | 22,000 | | | |
| 9,000 | | | | 23,000 | | | |
| 10,000 | | | | 24,000 | | | |
| 11,000 | | | | 25,000 | | | |
| 12,000 | | | | 26,000 | | | |
| 13,000 | | | | 27,000 | | | |

- Please decrease maintenance period when often driving in dusty areas.
- Copy the blank table to use when odometers is over the above table planned.