

DEAR CUSTOMERS :

Thank you for choosing **BIG-MAX (HOT)** of **PGO** scooter. It is a fact that the efficiency and sustaining life of each scooter depend heavily on the operating method of each user. Thus this owner's manual will provide you a precise knowledge of easy adjusting, sustaining and precaution for your scooter. We hope you will read and check it carefully.

Please recognize your scooter model clearly in order to read the following instruments.

If there is any question, please do not hesitate to ask your dealer for assistance.

We hope you will enjoy it !

Manufactured by:
Motive Power Industry Co., Ltd.

CONTENT

Warranty Card.....	1	Notation for operation and riding	27
Scooter safety	2	Starting the engine	27
Part location	4	Warming up the engine.....	28
Identification	6	Brake operation.....	29
The function of switch & controller.....	9	Engine initial run-in.....	30
Main switch	9	Parking vehicle	31
Speedometer	10	Periodical maintenance.....	32
Handlebar Controls.....	14	Periodical maintenance table	33
Fuel Tank Cap	16	The air cleaner	34
Kick Starter Lever	16	The spark plug	36
Steering Lock.....	17	Brake adjustment	37
Seat Lock	17	Brake fluid check.....	38
Luggage Compartment	18	Front fork check.....	39
Pre-riding inspection	19	Battery.....	40
Brake.....	20	Service Information	41
Brake Fluid	20	Wire diagram	45
Throttle Grip	22	Periodical maintenance record	47
Lubricant.....	22		
Air Cleaner	23		
Tire.....	23		
Lamp & Signal Light.....	26		

Check List before Delivery

Name : _____ Tel : _____ Age : _____ Sex : _____

Address : _____

Model : _____ Engine No : _____ VIN No : _____

Delivery date : _____ Year _____ Month _____ day _____ Dealer : _____

NO	Check Item	Y	N	NO	Check Item	Y	N
1	Steering of Handle Bar			8	Confirm Engine No & Document		
2	Gap of Brake Lever			9	Owner's Manual		
3	Lights and Horn			10	Operating Method Introduction		
4	Fuel Tank and Fuel Kind			11	Periodic Maintenance introduction		
5	Engine Oil			12	Warranty Introduction		
6	Disk Brake fluid						
7	Tire Pressure						
Staff Signature :				Customer Signature :			

Suggestion :

※Please Sign both customer & service Staff.

※Mail this chart to agent, and then the Warranty will be effective.



PGO Warranty Card

Name			Telephone	Registration date
Address				
Model	<input type="checkbox"/> BIG MAX -NAKED <input type="checkbox"/> BIG MAX	Displacement <input type="checkbox"/> 50 CC <input type="checkbox"/> 90 CC <input type="checkbox"/> 110 CC	Engine NO.	VIN. No.

Customer Signature

Dealer Signature

SCOOTER SAFETY

▲WARNING

.Scooter riding requires special afford on your part to ensure your safety.

Know these requirements before you ride:

SAFE RIDING RULES

1. Always make a pre-ride inspection(page 19) and perform any needed adjustments or repairs before you ride the scooter.
2. Many accidents involve inexperienced riders. Most countries require a special scooter riding test or license. Make sure you are qualified before your ride.
NEVER lend your scooter to an inexperienced rider.
3. Many automobile/scooter accidents happen because the automobile driver does not "see" the motorcyclist. Make yourself conspicuous to help avoid the accident that wasn't your fault:
 - Wear bright or reflective clothing.
 - Don't ride in another motorist's "blind spot"
4. Obey all national and local laws and regulations.
 - Excessive speed is a factor in many accidents. Obey the speed limits, and NEVER travel faster than conditions warrant.
 - Signal before your make a turn or lane change. Your size and maneuverability can surprise other motorists.

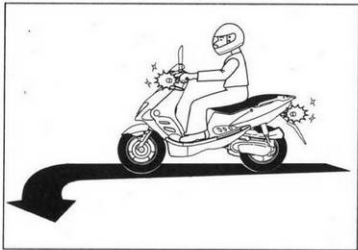

LEFT TURN

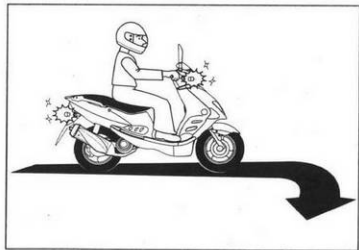

RIGHT TURN

5. Don't let other motorists surprise you. Use extra caution at intersections , parking lot entrances and exits, and driveways.
6. Keep both hands on the handlebars and both feet on the floorboards while riding. A passenger should hold on to the scooter or the feet on then passenger foot pegs.
7. Never leave your scooter unattended with the engine running.
8. Moderate your speed when ridding over bumpy roads. Avoid hitting road hazards, such as sharp bumps and holes, in the road surface. These hazards can cause loss of control or structural damage to the vehicle.

PARTS NAME for PS(BIG MAX) model:



Remarks: The accessory equipments shall according to actual vehicle. Above items are only for function description.

PARTS NAME for PS-NAKED model:



Remarks: The accessory equipments shall according to actual vehicle. Above items are only for function description.

IDENTIFICATION

1. Recognize your vehicle model according to license document or manufacturing document.
2. This manual includes 4 kinds of engine models:
 - BIG MAX-50: abbreviated as “PS-50” is 2 stroke (2T) / 50 C.C engine..
 - BIG MAX-90: abbreviated as “PS-90” is 2 stroke(2T) / 90cc engine.
 - BIG MAX-110: abbreviated as “PS-110” is 2 stroke(2T) / 110cc engine.
 - BIG MAX -NAKED: abbreviated as “PS-DN” is 2 stroke (2T) / 50 /110C.C engine.
3. Because this manual is suitable for all PM* serial models, there are many different operations between every model. Once you see a model indication bar appears above the page, for example:



The “ PS-DN “ model button lights on, and the lower bar is filled, that means this page is suitable for “PS-DN “.



IDENTIFICATION

2.Engine No. is located (stamped) on the rear side of the left crankcase,



NOTE:

The upper row is model type, the lower row is the production serial numbers.

Your dealer need this number for ordering the parts, please write down the engine no. for their reference.



IDENTIFICATION

3. Vehicle Identification Number (VIN) is located (stamped) inside the inner front cover.



NOTE:

The first 9 digitals are model type, the last 8 digitals are production serial numbers.

Your dealer need this number for ordering the parts, please write down the engine no. for their reference



FUNCTIONS OF EACH CONTROLLER

■ MAIN SWITCH:

THE MAIN SWITCH CONTROLLING THE IGNITION AND LAMPLIGHT SYSTEM. THE OPERATION METHODS ARE AS FOLLOWS:

1. ON:

ELECTRICAL CIRCUIT IS CONNECTED&ENGINE CAN BE STARTED. AT THIS MOMENT, THE KEY CAN'T BE PULLED OUT.

2. OFF:

ALL ELECTRICAL CIRCUITS ARE CUT AT THIS MOMENT, THE KEY CAN BE PULLED OUT.

3. LOCK:

IN THIS POSITION, THE HANDLE COMP. CAN BE LOCKED&KEY CAN BE PULLED OUT.

PLEASE REFER TO PAGE 17 HANDLE LOCK OPERATION.

NOTE: PLEASE TURN TO "OFF" OR "LOCK" (PULL OUT THE KEY) LOCATION WHEN PARK THE SCOOTER.





1. SPEED INDICATOR:

SHOW THE REAL TIME SPEED .

2. REAL TIME SPEED UNIT:

(KMH or MPH)

3. TRIP INDICATOR:

SHOWS HOW MANY (100 METERS) HAVE BEEN TRIPPED SINCE LAST RESET.

4. ACCUMULATED MILEAGE

SHOWS HOW MANY KILOMETERS (OR MILES) ACCUMULATED SINCE THIS SPEEDOMETER HAS BEEN USED.

5. FUEL INDICATOR

INDICATE THE VOLUME OF FUEL IN THE TANK. THE INDICATOR WILL MOVE FROM "F" (FULL) TO "E" (EMPTY), AS THE FUEL IS CONSUMING. WHEN SWITCH OFF, THE INDICATOR WILL DISAPPEAR.

6. WHEN ONLY 1 COLUMN FUEL IS RESIDUAL, THIS INDICATOR WILL TWINKLE, PLEASE REFILL.

FUEL

A.S.A.P

7. MODE BUTTON:

INTEGRATED INSIDE, NO FUNCTION !

8. SET BUTTON

➤ THIS BUTTON IS USED FOR RESET THE TRIP DISTANCE.

➤ TURN ON THE MAIN SWITCH, PRESS THIS BUTTON 1 SECOND, THEN TRIP DISTANCE WILL BE RESET TO "0".





9. OIL WARNING LAMP:

- IF THE OIL IS NOT ENOUGH, THE LIGHT WILL BE "ON", THEN YOU SHOULD REFILL THE OIL. AFTER THE OIL IS REFILLED, THE OIL WARNING LIGHT WILL BE OFF.
- WHEN THE MAIN SWITCH IS "ON", THE OIL WARNING LAMP WILL "ON" FOR A FEW SECONDS FOR SELF TEST. AND LATER IT WILL BE "OFF". IF THE LAMP IS NOT ON WHEN SELF TESTING, THE BULB MIGHT BE BURNED. PLEASE CHECK THE CIRCUIT SYSTEM OR TAKE IT TO YOUR DEALERS FOR CHECKING. PLEASE BE SURE THE OIL IS ENOUGH, THEN YOU MAY RIDE IT.





1. SIGNAL LIGHT INDICATOR
2. HIGH BEAM INDICATOR
3. OIL WARNING LAMP

1.SIGNAL LIGHT(GREEN):

WHEN OPERATING THE LAMP WILL FLASH WITH SOUND.

2.HIGH BEAM INDICATOR (BLUE): AS THE ENGINE START-UP LIGHTS INDICATING THAT THE HIGH BEAM IS WORKING

3.OIL WARNING LAMP(RED):

IF THE OIL IS NOT ENOUGH, THE LIGHT WILL BE "ON", THEN YOU SHOULD REFILL THE OIL. AFTER THE OIL IS REFILLED, THE OIL WARNING LIGHT WILL BE OFF



NOTE:

WHEN THE MAIN SWITCH IS "ON", THE OIL WARNING LAMP WILL "ON" FOR A FEW SECONDS AND LATER IT WILL BE "OFF" IF THE LAMP IS NOT ON, THE BULB MIGHT BE BURNED. PLEASE CHECK THE CIRCUIT SYSTEM OR TAKE IT TO YOUR DEALERS FOR CHECKING PLEASE BE SURE THE OIL IS ENOUGH THEN YOU MAY RIDE IT.



> SPEEDOMETER

4. FUEL GAUGE

INDICATE THE VOLUME OF FUEL IN THE TANK. THE INDICATOR WILL MOVE FROM "F" (FULL) TO "E" (EMPTY) AS THE FUEL IS CONSUMING. WHEN THE INDICATOR REACHES TO THE RED AREA, PLEASE REFILL FUEL A.S.A.P.

5. SPEED INDICATION AREA

6. ACCUMULATED MILEAGE

NOTE: WHEN SWITCH OFF, THE FUEL GAUGE INDICATOR WILL POINT AT THE "E" POSITION.

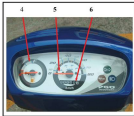

PS-ON

PS-50

PS-80

PS-110

HANDLE-BAR CONTROLS**1.HEAD BEAM SWITCH**

HI-The high beam is on "HD"

LO-The low beam is on "LD"

2.Turn Signal Switch

Move to ← to signal a left turn, → to signal a right turn.

Press to turn signal off.

3.Horn Button

When the horn button is pressed, the horn will sound.

4.Starter Button

The starter button (2) is below the headlight switch (1).

When the starter button is pressed, the starter motor cranks the engine.

5.HEADLIGHT Switch

ON-Headlight, position light, taillight and meter light will be on, when the engine is running.

6.Engine emergency Stop switch: (Right)

this switch is specified function; press down to stop the engine for emergency situation, and press up when you want to start the engine again.

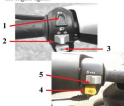



REAR&FRONT BRAKE LEVER(HANDLE):
HOLD THE HANDLE & PULL THE LEVER,
THE BRAKE WILL BE OPERATING

REAR



FRONT

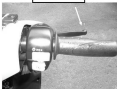



FUEL TANK COVER:

OPEN: INSERT THE KEY AND CLOCKWISE TURN 1/4, THEN THE COVER CAN BE OPENED.
CLOSE: INSERT THE COVER TO ITS ORIGINAL POSITION AND (COUNTERCLOCKWISE) TURN BACK & PULL OUT THE KEY.



NOTE: IN ORDER TO FASTEN TIGHTLY, THE COVER SHOULD BE PUT ON THE ORIGINAL POSITION (ARROW TO ARROW) AS SHOWING ON THE PICTURE.

KICK STARTER:

PULL THE KICKS OUT FROM THE ENGINE AND KICK DOWN, THEN THE ENGINE WILL BE STARTED. (USE KICK STARTER FOR, SUBSTITUTING TO PUSH THE START BUTTON)



PS-0N

PS-50

PS-90

PS-110

HANDLE (STEERING) LOCK

INSERT THE KEY INTO THE MAIN SWITCH & TURN TO THE LOCK POSITION AND TURN THE HANDLE BAR TO THE LEFT SIDE AT THE SAME TIME, THE HANDLE WILL BE LOCKED & THE KEY CAN BE PULLED OUT.



NOTE: DO NOT TURN TO LOCK POSITION DURING RIDING SEATLOCK.

SEAT LOCK

IF NEED TO OPEN THE SEAT, PLEASE INSERT THE KEY AND TURNING AS THE INSTRUCTED. PUT BACK THE SEAT TO ITS ORIGINAL POSITION FOR CLOSING & LOCKING





LUGGAGE COMP.

IT LOCATES UNDER THE SEAT. PUT YOUR HELMET UPSIDE DOWN AS THE PICTURE.

NOTE:

- 1.THE MAX. LOADING WEIGHT IS 1 KGS.
- 2.WHEN THE OUTSIDE WEATHER IS HOT & ENGINE HAS BEEN OPERATING FOR A LONG TIME, THE LUGGAGE WILL BECOME HOT. DO NOT PUT GOODS WHICH ARE NOT DURABLE FOR HEAT IN THE LUGGAGE COMP.
- 3.DO NOT PUT IMPORTANT OR FRAGILE GOODS IN IT.
- 4.WHEN RAINING OR WASHING THE SCOOTER, IT MAY BECOME WET. PLEASE USE WATER-PROOF MATERIAL TO COVER IT.
- 5.PLEASE LOCK THE COVER WHEN LEAVING THE SCOOTER.



INSPECTION BEFORE RIDING:

PLEASE DO THE INSPECTION AS FOLLOWS BEFORE RIDING-

ITEM	PROCEDURE	PAGE
FRONT BRAKE	CHECK THE BRAKE FUNCTION, CLEARANCE, BRAKE OIL LEVEL, SEE IF IT'S LEAKING IF NECESSARY, MAY REFILL FMVSS DOT 3 OR SAEJ 1703 BRAKE OIL.	15
BEAR BRAKE	CHECK THE BRAKE FUNCTION AND CLEARANCE. MAKE ADJUSTMENT IF NECESSARY.	15
THROTTLE GRIP	CHECK IF IT IS SMOOTH PUT SOME LUBRICANT & MAKE ADJUSTMENT IF NECESSARY.	22
LUBRICANT	ADJUSTMENTS IF NECESSARY. CHECK THE OIL LEVEL/ACCORDING TO THE NEED, REFILL OIL.	22
TIRE	CHECK THE PRESSURE THE WORN-OUT SITUATION.	23
CONTROLLER /GAUGE CABLE	CHECK IF SMOOTH ORERATION. ADD LUBRICANT IF NECESSART.	-
CENTRAL STAND	CHECK IF SMOOTH. ADD LUBRICANT IF NECESSARY.	-
ASSEMBLY/ FASTEN FITS	CHECK ALL THE ASSEMBLING PARTS. FIXING & ADJUST-ING IF NECESSARY.	-
FUEL TANK	CHECK THE FUEL LEVEL. REFILL UP IF NECESSARY.	16
LAMP/SIGNAL LIGHTS	CHECK IF IT IS OPERATING AT GOOD CONDITION.	26

BRAKE (REF. PAGE 36)

1.FRONT & REAR BRAKE LEVER-YOU MAY CHECK THE BRAKE DURING THE LOW SPEED RIDING. CHECK THE CLEARANCE, IF NOT CORRECT, PLEASE ADJUST.

NOTE: IF THE LEVER IS LOOSE, THAT MEANS THE BRAKE SYSTEM IS OUT OF ORDER (IT'S DANGEROUS), DO NOT RIDE IT BEFORE FIXING.

2.BRAKE OIL-CHECK THE OIL LEVEL, &FILL.



3.BRAKE OIL, IF NECESSARY,(USING FMVSS DOT 4 OR SAE J1703 BRAKE OIL)

4.CHECK THE PAD OF DISK BRAKE (REF. PAGE 38)

NOTE: TAKE YOUR SCOOTER TO YOUR DEALERS IF NEED TO CHANGE THE BRAKE DISK.

BRAKE OIL LEAK CHECK:

HOLD BRAKE LEVER FOR FEW MINUTES AND CHECK IF ANY OIL IS LEAKING FROM THE JOINT OF BRAKE TUBE OR MASTER CYLINDER.

NOTE: IF THE BRAKE OIL IS LEAKING, PLEASE LET YOUR DEALERS CHECK IT FOR YOU.
IT IS A DANGEROUS SITUATION

OUR SUGGESTION

1.THE INSPECTION SHOULD BE PROCEEDED BEFORE EVERY RIDING. THE ABOVE INSPECTION CAN BE DONE IN VERY SHORT TIME BUT WORTH MORE THAN THE TIME YOU WOULD HAVE SPENT.

2.DURING THE INSPECTION, IF ANY ABNORMAL IS FOUND, PLEASE TRY TO FIX IT TO GOOD CONDITION OR, CARRY IT TO YOUR DEALERS FOR HELP.



THROTTLE GRIP:

TURN THE GRIP AND CHECK THE CLEAR-ANCE & OPERATION SITUATION. MAKE SURE THE GRIP WILL AUTOMATICALLY RETURN TO THE ORIGINAL POSITION. ASK YOUR DEALERS FOR ADJUSTING IF NECESSARY.



LUBRICANT:

KEEP THE LUBRICANT BE FULL.

CAPACITY OF LUBRICANT: 1.1 LITER.



NOTE: DO NOT USE A NON-SPECIFIED LUBRICANT (WHICH IS NOT RECOMMENDED BY US), THAT MAY CAUSE HIGH DENSITY EMISSION.

AIR FILTER:

THE FUNCTION OF THE AIR FILTER IS TO PREVENT THE ASH ENTERING THE ENGINE AND WEAR OUT THE ENGINE. PLEASE ASK THE DEALERS TO CHECK & CLEAN THE FILTER FOR THE TIME BEING.



TIRE:

IN ORDER TO HAVE THE HIGHEST EFFICIENCY & SAFETY OPERATION, PLEASE PAY ATTENTION TO THE FOLLOWS:

1. TIRE PRESSURE-CHECK IF IT'S IN ACCORDANCE WITH THE STANDARD PRESSURE.

NOTE: THE TEMPERATURE OF THE INSIDE & OUTSIDE TIRE OUGHT TO BE THE SAME, THEN ACCORDING TO THE LOADING, RIDER'S WEIGHT & RIDING SPEED TO CHECK AND ADJUST THE TIRE PRESSURE.

THE NORMAL TIRE PRESSURE:

FRONT: 2.0 KG/CM²

REAR: 2.0 KG/CM²



1. TIRE PRESSURE TOO HIGH



2. TIRE PRESSURE TOO LOW

2. CHECKING: CHECK THE TIRE SITUATION BEFORE RIDING. IF THE OUTSIDE TIRE IS WORN OUT OR STABBED BY NAIL, GLASS OR CRACKING PLEASE ASK YOUR DEALERS FOR INSPECTION AND IF NECESSARY, CHANGE A SAME SPEC. TIRE.

3. INSPECTION FOR THE DEPTH OF THE TIRE GROOVE (TRACK): IF THE TIRE IS WORN OUT TOO MUCH, THE GROOVE WILL BE COVERED BY DIRT AND WHEN THE ROAD IS WET, THAT WILL BE EASY OF SLIDE DURING RIDING. PLEASE CHANGE THE TIRE IF THE DEPTH IS LESS THAN 0.8mm. REFER TO THE FOLLOWING PICTURE.



NOTE:

1. IT IS VERY DANGEROUS TO RIDE A SCOOTER WITH A WORN-OUT TIRE WHEN THE DEPTH OF THE TIRE DECREASING TO THE INDICATOR ARROW. PLEASE ASK YOUR DEALERS TO CHANGE THE TIRE FOR YOU.
2. THE REPLACEMENT OF BRAKE, TIRE AND WHEEL SHOULD BE DONE BY YOUR PGO DEALER, PLEASE DO NO DO IT BY YOURSELF.

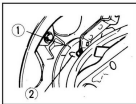

LAMPS & SIGNAL LINGHTS:

CHECK THE FRONT, SIGNAL-REAR, BRAKE, GAUGE LAMP AND ALL OTHER INDICATOR LIGHTS, TO ASSURE IF THEY ARE WORKING WELL.

SWITCHES:

CHECK THE SWITCH OF HEAD LAMP, SIGNAL, BRAKE LAMPS, HORN AND START BUTTON ETC. ALL THE SWITCHES AND MAIN SWITCHES SHOULD BE IN WORKING SITUATION.

FUEL (GASOLING):

MAKE SURE THERE'S ENOUGH FUEL IN THE TANK.

NOTE:

1. TANK CAPACITY: 5.1 Liter
2. DO NOT OVER-FILL UP THE GASOLINE (DON'T OVER THE NECK LINE), OTHERWISE IT WILL BE SPILLING OUT DUE TO THE HOT TEMPERATURE.
3. DO NOT SPILL OUT THE GASOLINE ON THE MUFFLER.

STARTING ENGINE:

NOTATION FOR OPERATION&RIDING:

1.PLEASE BE FAMILIAR WITH ALL THE OPERATION SYSTEM&FUNCTION BEFORE RIDING.
PLEASE CONTACT WITH YOUR DEALERS IF THERE'S ANY QUESTION.

2.DO NOT START THE ENGINE IN A CLOSED PLACE(WITHOUT VENT)

3.TURN THE MAIN SWITCH TO "ON"

4.WHEN THE THROTTLE IS TOTALLY CLOSED, HOLD THE BRAKE LEVER&PUSH THE START BUTTON OR USE THE KICKSTARTER TO START THE ENGINE.

NOTE: IF THE ENGINE CAN'T BE STARTED,

RELEASE THE START BUTTON. IN ORDER TO AVOID LOSING HUGE AMOUNT OF ELECTRICITY, PLEASE DO NOT PUSH THE BUTTON OVER 3 SECONDS EACH TIME. USE KICK STARTER TO START THE ENGINE IF THE START BUTTON IS NOT WORKING.



WARM UP THE ENGINE:

IN ORDER TO PROTECT THE ENGINE, PLEASE WARM UP THE ENGINE 1-3 MINUTES BEFORE RIDING. DO NOT ACCELERATE TOO FAST WHEN THE ENGINE IS COLD.

NOTE: PLEASE READ "ENGINE INITIAL RUNNING" (PAGE 30) BEFORE OPERATING THE SCOOTER.

SCOOTER RIDING:

AFTER WARMING UP THE ENGINE:

1. USE YOUR HAND TO HOLD THE BRAKE LEVER AND PUSH DOWN THE CENTRAL STAND.
2. CHECK THE REAR VIEW MIRROR ANGLE.
3. VIEWING THE TRAFFIC SITUATION, AND USE THE SIGNAL LIGHT BEFORE RIDING.
4. GRADUALLY TURN THE THROTTLE GRIP AND TURN OFF THE SIGNAL LIGHT AFTER RIDING.

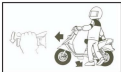

ACCELERATING (THROTTLING):

BY TURNING THE THROTTLE GRIP, THE SPEED CAN BE ADJUSTED. TURNING DOWN THE THROTTLE TOWARDS YOUR BODY (A), IT WILL SPEED UP. REVERSING IT (B) TO SLOW DOWN THE SPEED.

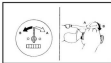

BRAKE USING:

1. RELEASE THE THROTTLE GRIP.

2. GRADUALLY PULL (PRESS) THE LEVER OF BOTH FRONT AND REAR BRAKE.

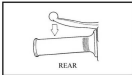

NOTE:

1. DO NOT STOP RAPIDLY TO AVOID SLIDING & FALLING DOWN.

2. BE CAREFUL TO USE THE BRAKING WHEN THE SCOOTER IS SLIDING TO ONE SIDE. INAPPROPRIATE USING OF THE BRAKE MAY CAUSE SLIDING.

3. SLOW DOWN THE SPEED ON THE PAVED IRON PLATE, RAIL WAY TRACK & WET ROAD.

4. IT IS DIFFICULT TO BRAKE ON THE WET ROAD & CLIMBING SLOPE. SLOW DOWN THE SPEED WHEN SLOPING DOWN.

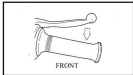

ENGINE INTIAL RUN-IN

MILEAGE FROM 1 TO 1,000 KMS IS THE MOST IMPORTANT PERIOD FOR THE SCOOTER'S SUSTAINING LIFE. THE NEW ENGINE CAN'T AFFORD TOO MUCH LOADING DURING THE FIRST 1,000 KM. EACH PART OF THE ENGINE WILL BE RUN-IN TO OBTAIN THE CORRECT CLEARANCE. IN THIS PERIOD, AVOID PROLONGING THE COMPLETE THROTTLING OUT OR ANY OPERATION WHICH MAY CAUSE HIGH TEMPERATURE IN THE ENGINE. PLEASE READ CAREFULLY THE ENGINE. PLEASE READ CAREFULLY THE FOLLOWING INFORMATION.

1. 0~150KMS

AVOID OVER 1/2 THROTTLING OPERATION. COOL DOWN THE ENGINE 5-10 MIN./PER HOUR. CHANGING THE SPEED(DO NOT CONTINUE AT THE SAME SPEED FOR TOO LONG.)

2. 150~500KMS

AVOID OVER 1/2 THROTTLING LONG OPERATION.

3. 500~1,000KMS

AVOID OVER 3/4 THROTTLING OPERATION.

NOTE: CHANGE GEAR OIL AFTER 300KMS

4. ABOVE 1,000KMS

AVOID THROTTLING OUT TOTALLY IN A LONG PERIOD OPERATION.

NOTE: IF THERE IS ANY PROBLEM DURING THE INITIAL RUN-IN PERIOD, PLEASE CONTACT YOUR DEALERS.

PARKING:

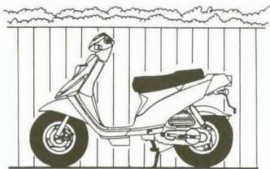

CORRECT



INCORRECT



INCORRECT

TURN OFF THE ENGINE AND PULL OUT THE KEY WHEN PARKING THE SCOOTER.

NOTE: BECAUSE THE MUFFLER IS VERY HOT (AFTER RIDING), PLEASE PARK YOUR SCOOTER FAR FROM THE CHILD & REDESTRIANS TO AVOID THEM TOUCHING IT. DO NOT PARK YOUR SCOOTER ON A SLOPE OR SOFT GROUND TO AVOID FALLING DOWN.

PERIODICAL MAINTENANCE AND CONCISE REPAIRING:

TO SECURE THE MOST SAFE AND EFFECTIVE PERFORMANCE, PLEASE CHECK, ADJUST AND LUBRICATE YOUR SCOOTER PERIODICALLY. "SAFETY CONSIDERATION" SHOULD BE EVERY RIDER'S PRIORITY AND MAINTENANCE TABLE SHOULD BE AN IMPORTANT GUIDE FOR CONCISE REPAIRING. MEANWHILE, PLEASE PAY ATTENTION TO THE ENVIRONMENT, CLIMATE, GEOGRAPHY AND RIDING CONDITION TO SET UP A PROPER MAINTENANCE INTERVAL.

NOTE:

THIS SCOOTER IS DESIGNED TO BE RIDING ON NORMAL PAVED ROAD. IF UNDER A DIRT AND WET COND-ITION, PLEASE CLEAN THE AIR-FILTER FREQUENTLY OTHERWISE THE ENGINE WILL BE WORN-OUT QUICKLY. IF YOU ARE NOT FAMILIAR WITH THE INSPECTION AND PRECAUTION, PLEASE CONTACT YOUR DEALERS.

CLEANING THE AIR-CLEANER:

1. OPEN THE LUGGAGE COMP.

2. (a) TAKE OFF THE TANK (INCLUDING THE SEAT), (b) TAKE OUT THE LUGGAGE COMP.

(c) TAKE OUT FUEL TANK COVER. (d) TAKE OFF THE FRONT COVER. (e) TAKE OFF BODY COVER.

3. SCREW OUT THE 4 SCREWS AND TAKE OFF THE AIR-CLEANER COVER.

4. TAKE OUT THE SPONGE, AND CLEAN IT.



NOTE: USING SOLVENT TO CLEAN THE PONGE ONLY. DO NOT USE FLAMMABLE & EXPLOSIVE SOLVENT.



5. DRY OUT THE SOLVENT OF THE SPONGE BUT AVOID DESTROYING IT.
6. REFILL FEW LUBRICANT OIL ON THE SURFACE OF THE SPONGE (ONLY WET IT BUT NOT DIP IT IN THE OIL).
7. PUT BACK THE SPONGE ON THE AIR CLEANER AND PERFECTLY FASTEN THE COVER WITHOUT ANY LEAKING.
8. ASSEMBLE THE AIR-CLEANER & PUT BACK

TO ITS ORIGINAL PLACE. PLEASE MAKE SURE THAT THE SCREWS ARE FASTENED TO AVOID CLEANER GO INTO THE ENGINE.

NOTE: PLEASE DO NOT START THE ENGINE BEFORE THE AIR-CLEANER IS ASSEMBLED, OTHERWISE THE PISTON/MAIN CASE WILL BE BADLY WORN OUT.

CHECKING THE SPARK PLUG:

SPARK PLUG IS ONE OF THE IMPORTANT PARTS OF THE ENGINE AND IT IS EASY TO BE CHECKED. ACCORDING TO SPARK PLUG CONDITION, YOU MAY ENTER THE SITUATION OF THE ENGINE. THE IDEAL COLOR OF THE ELECTRODE SHOULD BE LIGHT BROWN. IF THERE'S ANY PROBLEM, PLEASE ASK YOUR DEALERS TO CHECK FOR YOU. PLEASE TAKE OFF THE SPARK PLUG AFTER A PERIOD OF TIME BECAUSE IT WILL BE CORRODED & WORN OUT DUE TO THE HEAT AND DIRT FOR THE TIME BEING. IF HAPPENED, PLEASE CHANGE A NEW SPARK PLUG.

Standard Spark Plug : BPT15 (NGK) or

SPARK PLUG GAP ADJUSTMENT

SPARK PLUG GAP: 0.6-0.7mm (ITEM a)

WHEN CHECKING THE SPARK PLUG PLEASE CLEAN THE SURFACE OF THE WASHER AND SCREW, THEN FASTEN IT.

TORQUE: 2.8 KOP-M

NOTE: IF THERE IS NO WRENCH (TOOLS) WITH YOU, PLEASE WRENCH IT BY YOUR FINGERS; TURN 1/4-1/2 AND LATER USING THE WRENCH(TOOLS) TO FIX IT TO THE STANDARD TORQUE.

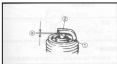

BRAKE ADJUSTING:

THE CLEARANCE OF LEVER

- (a) FRONT BRAKE: 10-20 mm
- (b) REAR BRAKE: 10-20 mm

IF THE CLEARANCE IS INCORRECT, PLEASE ADJUST IT.

NOTE: IF THE BRAKE CLEARANCE IS INCORRECT, THAT MEANS THE BRAKE SYSTEM IS DANGEROUS.

PLEASE DO NOT RIDE IT AND ASKING YOUR DEALERS TO CHECK & ADJUST IT FOR YOU.

CHECK THE LINING:

THERE IS ONE INDICATOR FOR CHECKING THE LINING, YOU CAN CHECK THE LINING BY VIEWING THE INDICATOR (NOT NEED TO TAKE THE BRAKE OFF) SEE IF IT'S WORN OUT OR NOT. IF THE INDICATOR POINTS TO THE LIMIT LINE, PLEASE ASK YOUR DEALERS TO CHANGE IT.

1. INDICATOR
2. LIMIT LINE



ADJUSTING NUT



FRONT BRAKE:

1. Front /Rear brake levers

Inspect the free play of levers. Make sure the function is well.

Please check the brake at low speed, adjust the free play if it is not correct.

CAUTION

If the brake lever feels soft when operating, which means the brake system has problem. Do not ride the scooter before the problem is ruled out.

2. BRAKE FLUID (Disk Brake)

Check the fluid level. Refill it if necessary. Fluid Spec. FMVSS Dot3 or SAE J1703

3. DISK BRAKE PAD

Please refer to page 36. Please go to the PGO dealer when this brake needed repairing.

BRAKE OIL:

Insufficient brake oil will make the air going through the brake system and might cause the brake to lose control.

Please check the brake oil level and refill it if necessary.

Please obey the following precaution.



1. When checking the oil level, please turn the handle bar assuring that the brake oil is in horizontal position.
2. Use correct brake oil. Otherwise the oil seal will be defected. This may cause the oil leaking & lose its function.

RECOMMENDED BRAKE OIL:

FMVSS DOT 3 OR SAE J1703 BRAKE OIL.

- REFILL THE SAME KIND OF BRAKE OIL. MIXING OF DIFFERENT OIL & TYPES WILL YIELD A BAD CHEMICAL REACTION AND CAUSE THE BRAKE OUT OF ORDER.
- TO AVOID THE WATER GETTING INTO THE MAIN CYLINDER, OTHERWISE THE BOILING TEMPERATURE OF THE BRAKE OIL WILL BE DECLINING AND MAKE THE AIR BE OBSTRUCTED.
- BRAKE OIL COULD DAMAGE THE PAINT SURFACE AND PLASTIC PARTS. IF ANY OIL IS SPILLED OUT, PLEASE CLEAN IT IMMEDIATELY.
- IF THE BRAKE OIL CAN'T BE REFILLED TO THE STANDARD LEVEL, PLEASE CHECK WITH YOUR DEALERS



1.EYE CHECKING 2. OPERATION

FRONT FORK CHECKING:

NOTE: IN ORDER TO AVOID FALLING DOWN, PLEASE UPHOLD THE SCOOTER SAFELY.

- CHECKING BY EYES-CHECK IF THE INNER PIPE IS SCRATCHED, BROKEN, OR LEAKING
- OPERATING CHECK: PUT THE SCOOTER IN A PLAIN SURFACE.
 - HOLD THE HANDLE AND KEEP THE SCOOTER IN VERTICAL POSITION, THEN HOLD THE FRONT BRAKE LEVER.
 - MOVE UP & DOWN THE FRONT FORK FOR A COUPLE OF TIMES.

NOTE: IF FOUND THE FRONT FORK IS NOT SMOOTH OR BROKEN, PLEASE CONTACT WITH YOUR DEALER.

BATTERY:

THE BATTERY IS MF (MAINTENANCE FREE) TYPE, SO YOU DON'T NEED TO CHECK THE LIQUID NOR REFILLING IF THE LIQUID IS LEAKING, PLEASE CHECK WITH YOUR DEALER.

NOTE: PLEASE DO NOT TAKE OFF THE SEAL RUBBER CAP OF THE BATTERY. THAT WILL DAMAGE YOUR BATTERY SYSTEM.

OPERATION SITUATION. IF THE NEW FUSE IS BURNED OUT AGAIN, PLEASE CONTACT WITH YOUR DEALER.

NOTE: DO NOT USE A HIGHER AMPERE FUSE THAN THE ORIGINAL SPEC. A DIFFERENT (ABNORMAL) FUSE WILL SERIOUSLY DAMAGE THE BATTERY SYSTEM AND MIGHT CAUSE FIRE.

CHANGING FUSE :

- 1.THE FUSE IS LOCATED BEHIND THE BATTERY (UNDER THE STEP BOARD)
 - 2.TAKE OFF 2 SCREWS ON THE COVER (6) THE COVER.
- IF THE FUSE IS BURNED OUT, TURN OFF THE MAIN SWITCH AND THE SWITCH OF THE RELATED PARTS. CHANGE A NEW CORRECT FUSE, TURN ON THE SWITCH AND CHECK THE



SERVICE INFORMATION

TYPE	PS-50DN
DIMENSION:	
OVERALL LENGTH	~1785 mm
OVERALL WIDTH	~670 mm
OVERALL HEIGHT	~1104 mm
WHEELBASE	1195 mm
DRY WEIGHT	~81 kg
ENGINE:	
TYPE	Two stroke, forced air cooling
MODEL NO.	P2
CYLINDER ARRAY	SINGLE
PISTON DISPLACEMENT	49.0 cc
START SYSTEM	ELECTRIC AND KICK
LUBRICATION SYSTEM	SEPARATE
LUBRICANT	Recommend two stroke oil (FC class)
CAPACITY	1.1 L
GEAR OIL:	
MODEL	API SAE 140
CAPACITY	110 cc
REPLACEMENT VOLUME	90 cc

SERVICE INFORMATION

TYPE	PS-50DN
AIR CLEANER	SPONGE FILTER
FUEL: GASOLINE CAPACITY OF TANK	UNLEADED ~5.1 Liter
SPARK PLUG	BP7HS(NGK) FOR GENERAL, OR BPR7HS(NGK) FOR REGULATION
CLUTCH TYPE	DRY TYPE
GEAR SHIFT TYPE	AUTOMATIC(V BELT)
TIRE SIZE (FRONT) (REAR)	120/90-10 130/90-10
ELECTRIC SYSTEM IGNITION SYSTEM GENERATOR SYSTEM BATTERY TYPE CAPACITY OF BATTERY	CDI FLYWHEEL MAGNET ELECTRIC YT4L-BS 12V-3AH
BULB VOLT/QUANTITY HEAD LAMP LAMP TYPE REAR LAMP/STOP LAMP SIGNAL LAMP	12V-18W/18W * 2(or 35Wx1 for DOT spec.) 12V- 5W/21W * 1 12V- 10W * 4 (or 16Wx4 for DOT spec.)

PGO SCOOTERS

比能久機車

PS-50

PS-110

SPECIFICATION LIST

TYPE	PS*-50	PS*-110
DIMENSION:		
OVERALL LENGTH	~1785 mm	~1785 mm
OVERALL WIDTH	~670 mm	~670 mm
OVERALL HEIGHT	~1104 mm	~1104 mm
WHEELBASE	1195 mm	1195 mm
DRY WEIGHT	~87 kg	~89 kg
ENGINE:		
TYPE	Two stroke, forced air cooling	Two stroke, forced air cooling
MODEL NO.	P2	P0
CYLINDER ARRAY	SINGLE	SINGLE
PISTON DISPLACEMENT	49.0 cc	106.2 cc
START SYSTEM	ELECTRIC AND KICK	ELECTRIC AND KICK
LUBRICATION SYSTEM	SEPARATE	SEPARATE
LUBRICANT	Recommend two stroke oil (FC class)	Recommend two stroke oil (FC class)
CAPACITY	1.1 Liter	1.1 Liter
GEAR OIL:		
MODEL	API SAE 140	API SAE 140
CAPACITY	110 cc	110 cc
REPLACEMENT VOLUME	90 cc	90 cc

SPECIFICATION LIST

TYPE	PS*-50	PS*-110
AIR CLEANER	DRY PAPER FILTER	DRY PAPER FILTER
FUEL: GASOLINE CAPACITY OF TANK	UNLEADED ~5.1 Liter	UNLEADED ~5.1 Liter
SPARK PLUG	BP7HS(NGK) OR BPR7HS(NGK) REGULATION	BP7HS(NGK) OR BPR7HS(NGK) REGULATION
CLUTCH TYPE	DRY TYPE	DRY TYPE
GEAR SHIFT TYPE	AUTOMATIC(V BELT)	AUTOMATIC(V BELT)
TIRE SIZE (FRONT) (REAR)	120/90-10 130/90-10	120/90-10 130/90-10
ELECTRIC SYSTEM IGNITION SYSTEM GENERATOR SYSTEM BATTERY TYPE CAPACITY OF BATTERY	CDI FLYWHEEL MAGNET ELECTRIC YT4L-BS 12V-3AH	CDI FLYWHEEL MAGNET ELECTRIC YTX5L-BS 12V-4AH
BULB VOLT/QUANTITY HEAD LAMP LAMP TYPE REAR LAMP/STOP LAMP SIGNAL LAMP	12V-18W/18W * 2 (or 35Wx1 for DOT spec.) 12V- 5W/21W * 1 12V- 10W * 4 (or 16Wx4 for DOT spec.)	

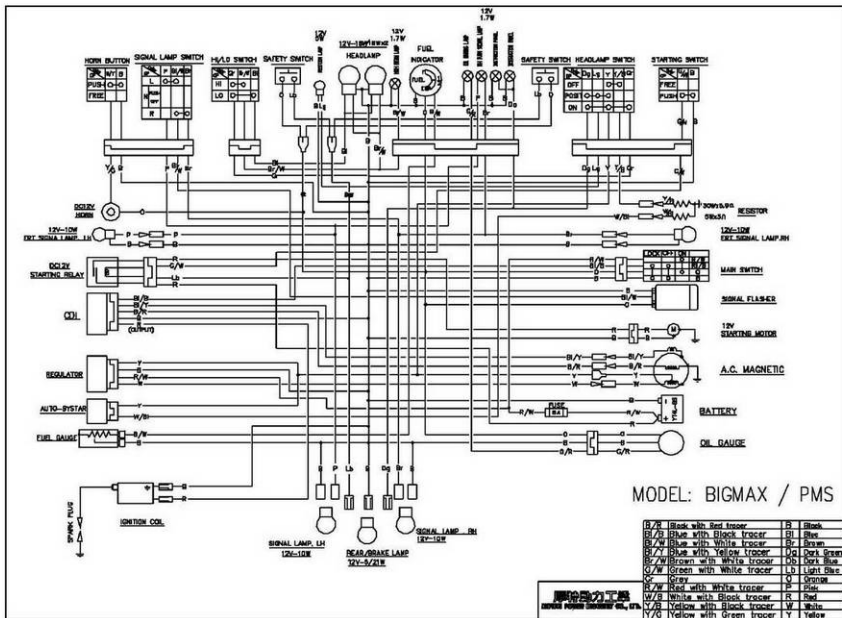

MODEL: BIGMAX / PMS

B/R	Black with Red tracer	B	Black
B/B	Blue with Black tracer	Bl	Blue
B/W	Blue with White tracer	Br	Brown
B/Y	Blue with Yellow tracer	Bg	Dark Green
B/W	Brown with White tracer	Db	Dark Blue
G/W	Green with White tracer	Lb	Light Blue
G	Grey	O	Orange
R/W	Red with White tracer	Pk	Pink
W/B	White with Black tracer	R	Red
Y/B	Yellow with Black tracer	W	White
Y/G	Yellow with Green tracer	Y	Yellow

廣州動力工廠
 總經銷 廣州 廣利 廣和 廣生 廣泰 廣順 廣發 廣興 廣隆 廣盛 廣茂 廣豐 廣裕 廣利 廣和 廣生 廣泰 廣順 廣發 廣興 廣隆 廣盛 廣茂 廣豐 廣裕

Periodic Maintenance Record

Plan km	Actual km	Date	Dealer Sign.	Plan km	Actual km	Date	Dealer Sign.
300				14,000			
1,000				15,000			
2,000				16,000			
3,000				17,000			
4,000				18,000			
5,000				19,000			
6,000				20,000			
7,000				21,000			
8,000				22,000			
9,000				23,000			
10,000				24,000			
11,000				25,000			
12,000				26,000			
13,000				27,000			

- Please decrease maintenance period when often driving in dusty areas.
- Copy the blank table to use when odometers is over the above table planned.