



OWNER'S MANUAL

onyx  
50



Thanks for your purchasing of the GenericONYX50. This model is designed for safety, built for durability, and perfected for daily street use. The unique of Generic vehicle design, enrich of stylish and peronality, represents your outstanding taste and favor to pursue the state of the art living attitude.

This manual describes the correct usage of this motorcycle including safety riding, simple inspection methods and so on. For a more comfortable and safety riding, please read this manual carefully. If any questions concerning the operation or maintenance of your scooter, please consult a Generic dealer.

# IMPORTANT MANUAL INFORMATION

In this manual with some important information is distinguished by the following notations:

**⚠ WARNING** it is WARNING instructions that need to follow, failure of follow could be end result severe injury or lead to death to the operator, a bystander, or a person who is inspecting or repairing the scooter.

**CAUTION:** A CAUTION indicates with special precautions to avoid damage to the scooter.

**NOTE:** A NOTE provides key information.

NOTE:

- Please always put this manual with vehicle for rider maintenance/ Dealer tracking of service records even if vehicle is being sold.
- This manual contains the most of the vehicle information, however, Generic will continually improve its product design and quality that lead to difference between the manual and vehicle. If you have any questions concerning this manual, please consult your Generic dealer.

**WARNING!!**

**FOR YOUR OWN SAFETY, PLEASE READ THIS MANUAL CAREFULLY BEFORE OPERATION THIS SCOOTER. ONLY OPERATE THE SCOOTER UNTIL YOU HAVE COMPLETELY AWARE OF ADEQUATE KNOWLEDGE OF CONTROLS AND OPERATION FEATURE AND YOU HAVE BEEN TRAINED IN SAFE AND PROPER RIDING TECHNIQUES. PERIODIC INSPECTIONS, WELL MAINTENANCE AND GOOD RIDING SKILLS, WILL ENSURE YOUR SAFETY RIDING AND INCREASE THE PRODUCT RELIABILITY OF THIS SCOOTER**

\*Product and specifications are subject to change without notice.

# IMPORTANT MANUAL INFORMATION



Generic Dealer label here

ONYX50 OWNER'S MANUAL

# TABLE OF CONTENTS

<b>SAFETY INFORMATION</b> .....	<b>1-1</b>
Other safetyriding points.....	1-3
Location of labels .....	1-4
<b>DESCRIPTION</b> .....	<b>2-1</b>
Left view .....	2-1
Right view .....	2-2
Controls and instruments .....	2-3
<b>INSTRUMENT AND CONTROL FUNCTIONS</b> .....	<b>3-1</b>
Main switch/steering lock .....	3-1
Indicator and warning lights .....	3-2
Dashboard unit .....	3-2
Fuel gauge .....	3-3
Handlebar switches .....	3-3
Front brake lever .....	3-4
Rear brake lever .....	3-4
Fuel and 2-stroke engine oil tank caps .....	3-5
Fuel .....	3-6
Catalytic converter .....	3-7
2-stroke engine oil .....	3-7
Kickstarter .....	3-7
Seat .....	3-8
Helmet holder .....	3-8
Storage luggage Box.....	3-9
Front hook, helmet .....	3-10
Front storage box.....	3-10
Rear Carrier.....	3-10
Shelf front como(For PIZZA model) ....	3-11
Sidestand / Pedal .....	3-11

<b>PRE-OPERATION CHECKS</b> .....	<b>4-1</b>
Pre-operation check list .....	4-2
<b>OPERATION AND IMPORTANT RIDING POINTS</b> .....	<b>5-1</b>
Starting and warming up a cold engine .....	5-1
Starting off .....	5-2
Acceleration and deceleration .....	5-3
Braking .....	5-3
Engine break-in .....	5-4
Parking .....	5-4

<b>PERIODIC MAINTENANCE AND MINOR REPAIR</b> .....	<b>6-1</b>
Owner's tool kit .....	6-1
Periodic maintenance chart for the emission control system .....	6-2
General maintenance and lubrication chart .....	6-3
Removing and installing the battery cover and center cover.....	6-6
Checking the spark plug .....	6-6
Final transmission oil .....	6-8
Cleaning the air filter element.....	6-9
Carburetor .....	6-10
Checking the throttle cable free play .....	6-11
Tires .....	6-12
Cast wheels .....	6-13
Checking the front brake lever free	

play .....	6-13
Adjusting the rear brake lever free play .....	6-13
Checking the front brake pads and rear brake shoes .....	6-14
Checking the front brake fluid level .....	6-15
Changing the brake fluid .....	6-16
Checking and lubricating the cables .....	6-16
Checking and lubricating the throttle grip and cable.....	6-16
Adjusting the Autolube pump .....	6-17
Lubricating the front and rear brake levers .....	6-17
Checking and lubricating the main stand .....	6-18
Checking the front fork .....	6-18
Checking the steering .....	6-19
Checking the wheel bearings .....	6-19
Battery .....	6-20
Replacing the fuse .....	6-21
Replacing a headlight bulb.....	6-22
Front turn signal light.....	6-22
Replacing rear turn signal light bulb -b.....	6-22
Tail/brake and licesnes light.....	6-22
Replacing a headlight bulb(For PIZZA model).....	6-23
Front turn signal light(For PIZZA model) .....	6-23

Troubleshooting .....	6-23
Troubleshooting chart .....	6-24
<b>SCOOTER CLEAN AND STORAGE ...</b>	<b>7-1</b>
Clean.....	7-1
Storage .....	7-3
<b>SPECIFICATIONS .....</b>	<b>8-1</b>
<b>CONSUMER INFORMATION .....</b>	<b>9-1</b>
Identification numbers .....	9-1
Warranty information .....	9-2
Service plan .....	9-3
Wiring diagram.....	9-4

THIS SCOOTER ARE TWO WHEEL SINGLE TRACK VEHICLES. THE USE OF SAVETY AND OPERATION MAY IN DIFFERENT RESULT BY THE USE OF PROPER RIDING TECHNIQUES OF THE OPERATOR.

TO REMIND OF OPERATOR, WHO SHOULD KNOW THE FOLLOWING REQUIREMENTS BEFORE RIDING.

HE OR SHE SHOULD:

- WELL TRAINED AND FAMILIAR TO ALL THE ASPECTS OF SCOOTER OPERATION.
- FULLY READ AND AWARE OF MAINTENANCE REQUIREMENTS THAT NOTED IN THIS OWNER'S MANUAL.
- OBTAIN QUALIFIED TRAINING & LEGAL LICENSE FOR OPERATION OF THIS VEHICLE.
- WELL AND PROFESSIONAL MAINTENANCE SERVICE FOR OPERATOR AND CERTIFICATED REPAIR SHOP/GENERIC DEALER TO ACQUIRE GOOD MECHANICAL CONDITIONS OF VEHICLE.

Safe riding

- Always pre-check your vehicle before riding is key point to prevent an accident.
- please follow the maxium loads limited of operator and passenger.
- Most of accident on the motorists is cased by automobile driver who "failure to recognize out the vehicle" and caused mobile/scooter accidents. Therefore, to make your -self conspicuous appear to public will be very effective in reducing the change of this kind of accidents

Therefore:

- Wear a brightly colored and protective clothes/Jacket
- Operate the turning signals before turning and slow down the Speed when approaching and passthrough the intersection.
- Keep proper distance with other Motorists, and let them aware of your location.
- Know your skills and limits.
- Never lend your scooter to others who not qualified for riding

- Always follow the legal speed limit on the scooter and traffic law.
- The posture of the operator and passenger is important for proper control. properly riding posture can Keep scooter in balance while riding.

- Operator should sit up-right with two hand hold on handle bar, foot on floorboard while driving.
- Passenger should make sure that he/she can firmly hold on grip or oepreator with foot step on foot-rest.

- Drving after Acohol drink or other illegal drugs is strickly prohibited.
- This scooter is designed for on-road use only. It is not suitable for off-road use.

Protective clothing

Properly clothing yourself will keep you safety from potential accidents:

- Always wear an approved helmet.
- with face shield to protect your eye from dust and rain drop.

- The wear of proper jacket, shoes, groves etc., can be better protection, reducing the degree of injury from un-expected accident.
- Never wear loose-fitting clothes, otherwise they could catch on the control levers or wheels and cause injury or an accident.
- Never touch the engine or exhaust system during or after operation. They become very hot and can cause burns. Always wear protective clothing that covers your legs, ankles, and feet.

## Modifications

Modifications made to this scooter that not approved by Generic, or the removal of original equipment, may let scooter unsafe for use and cause severe personal injury. Modifications may also make your scooter illegal to use.

## Loading and accessories

Adding accessories or cargo to your scooter may cause the different on the weight distribution of scooter and influence on the steering & balance.

It may cause possibility of an accident, Please extremely caution and follow below limitation when you equipped with accessories. Below are some general or accessories. Here are some guidelines to follow if loading cargo or adding accessories to your scooter:

### Loading

The total weight of the operator, passenger, accessories and cargo must not exceed the maximum load limit.

Maximum load(not include the vehicle) : 150 kg
---

When loading within this weight limit, keep the following in mind:

- Cargo and accessory weight should be kept as low and close to the scooter as possible. Make sure to distribute the weight as evenly as possible on both sides of the scooter to minimize imbalance or instability.
- Make sure that accessories and cargo are securely attached to scooter before riding

- Never attach any large or heavy items to the handlebar, front fork, or front fender. Such items can create unstable handling or a slow steering response.

### Accessories

Genuine Generic accessories have been specifically designed for use on this scooter. If need, please contact with Generic dealer for detail. Since Generic can not test all other accessories, you must personally be responsible for the proper selection, installation and use of non-Generic accessories.

Keep the following guidelines in mind, when mounting accessories.

- Never install accessories or carry cargo that would influence on the ground clearance, limit suspension travel, steering, or obscure lights or turning lights, reflectors.
- Accessories on the handle bar/front suspension area will cause bad influence on steering the scooter. if you will install accessories, please keep it as light in weight and not interfere on steering the vehicle.



- This vehicle is for On-Road transportation purpose only, please do not install any of extended cargo carrier as sulky, that will make scooter unstable in cross winds and vehicle turns.
- while equip with electrical accessories, please consult with qualified series, to make sure such items will not exceed the capacity of the scooter's electrical system. improper install of such items may cause a dangerous loss of lights, lower engine power or even damage the vehicle.

## Gasoline and exhaust gas

- **GASOLINE IS HIGHLY FLAMMABLE:**
  - Always turn the engine off when refueling.
  - Take care not to spill any gasoline on the engine (hot) or exhaust system when refueling.
  - Do not smoke or use Mobile phone while re-fueling .

- Never start the engine or let it run for any length of time in a closed area. The exhaust fumes are poisonous and may cause loss of consciousness and death within a short time.
- Always turn the engine off before leaving the scooter and remove the key from the main switch. When parking the scooter, please note the following:
  - The engine and exhaust system remain hot, therefore, park the scooter in a place where pedestrians or children are not likely to touch these hot areas.
  - Do not park the scooter on a slope or soft ground, otherwise it may fall over.
  - Do not lay your scooter to near flammable place.
- In case of swallow any gasoline, or gasoline get into your eyes, please see your doctor immediately. Keep away the gasoline to your skin and water.

## Other safe-riding points

- Turn the signal before making turns.
- When raining or across on run on the wet road, Iron Plates, keep your speed low, slightly using braking to avoid slipping or even fall down.
- Be careful when passing parked cars. A driver might not see you and open a door in your path.

## Location of labels

There are two labels that in the scooter and location as noted.

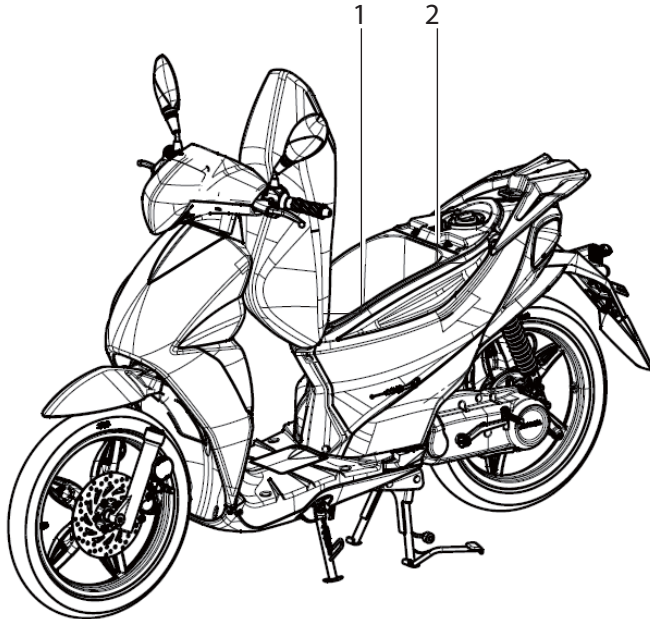

### 1.WARNING LABEL, FUEL



### 2.LABEL, ANTI-TAMPERING

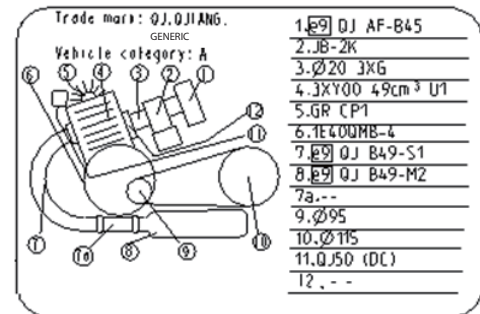

## Left view

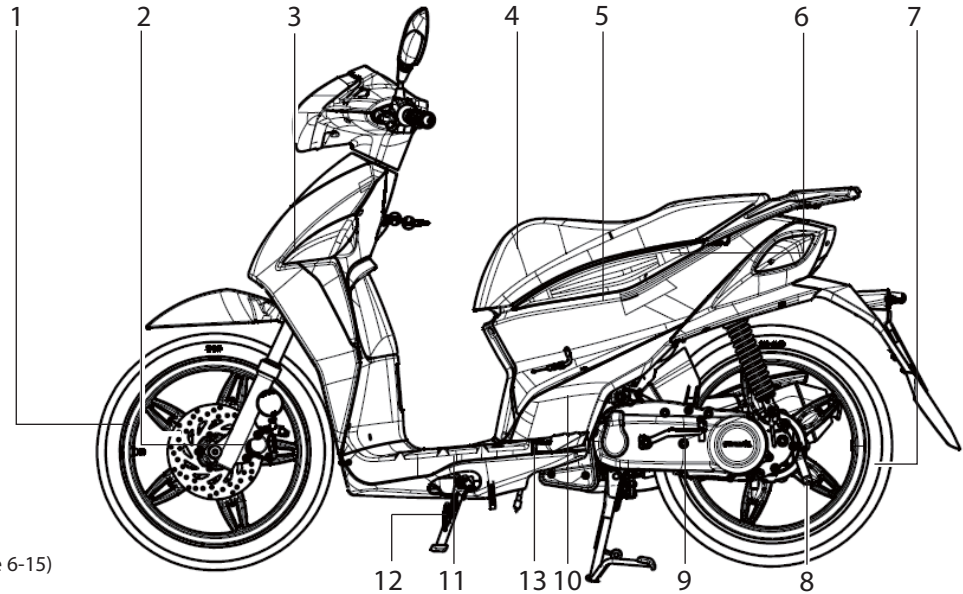

1. Front wheel
2. Front brake caliper (page 6-15)
3. Front turn signal light
4. Helmet holder (page 3-8)
5. Storage compartment (page 3-9)
6. Rear turn signal light
7. Rear wheel
8. Adjusting nut (page 6-15)
9. Kickstarter (page 3-7)
10. Air filter element (page 6-10)
11. Battery (page 6-21)
12. Sidestand (page 3-11)
13. Pedal (page 3-11)

## Right view

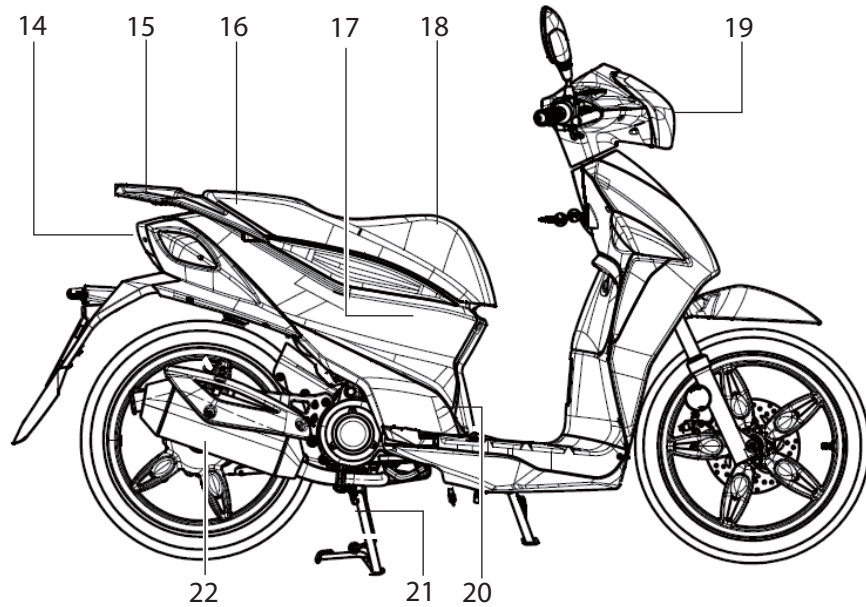

- 14. Tail/brake light
- 15. Carrier (page 3-10)
- 16. Fuel tank cap
- 17. 2-stroke engine oil tank cap
- 18. Seat (page 3-8)
- 19. Headlight
- 20. Spark plug (page 6-7)
- 21. Mainstand
- 22. Muffler

## Controls and instruments

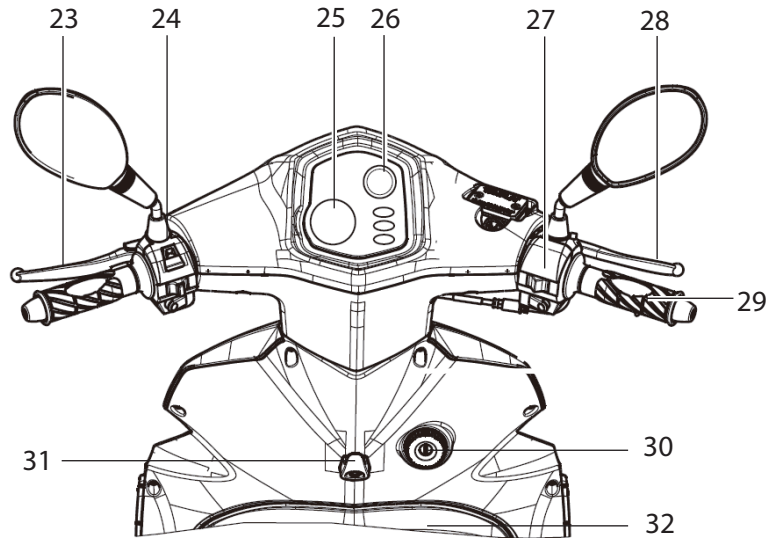

- 23.Rear brake lever (page 3-4)
- 24.Left handlebar switches (page 3-3)
- 25.Speedometer unit (page 3-2)
- 26.Fuel gauge (page 3-3)
- 27.Right handlebar switches (page 3-3)
- 28.Front brake lever (page 3-4)
- 29.Throttle grip (page 6-12)
- 30.Main switch/steering lock (page 3-1)
- 31.Hook,Helmet (page 3-10)
- 32.Front storage compartment (page 3-10)

## Main switch/steering lock/seat open

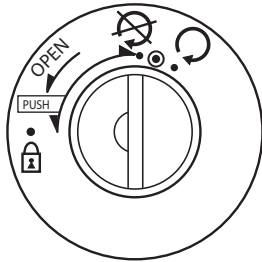

The main switch/steering lock controls the ignition and lighting systems, and also used to lock the steering, open the luggage box. The various positions are described as below.

### ON "☉"

All electrical circuits are supplied with power, the engine can be started. The key cannot be removed.

NOTE: \_\_\_\_\_

The headlight, meter lighting and tail-light come on automatically when the engine is started.

### OFF "⊗"

All electrical systems are off. The key can be removed.

### CHECK "●"

The 2-stroke engine oil level warning light should come on. (See page 3-2.)

### LOCK "⌚"

The steering is locked, and all electrical systems are off. The key can be removed.

### To open the seat

1. Push the key in from the "⊗" position, and then turn it to "⌚"

### To lock the steering

1. Turn the handlebars all the way to the left.
2. Push the key in from the "⊗" position, and then turn it to "⌚" while still pushing it.
3. Remove the key.

### To unlock the steering

Push the key in, and then turn it to "⊗" while still pushing it.

### **! WARNING**

Never turn the key to "⊗" or "⌚" while the vehicle is moving, otherwise the electrical systems will be switched off, which may result in loss of control or an accident. Make sure that the vehicle is stopped before turning the key to "⊗" or "⌚".

## Indicator and warning lights



1. Turn signal indicator light "↔"
2. High beam indicator light "≡D"
3. 2-stroke engine oil level warning light "🛢"

### Turn signal indicator light "↔"

This indicator light flashes when the turn signal switch is pushed to the left or right.

### High beam indicator light "≡D"

This indicator light comes on when the high beam of the headlight is switched on.

## 2-stroke engine oil level warning light

"🛢"

The warning light comes on when the key is in the "🔑" position or when the engine oil level in the 2-stroke engine oil tank is low during operation. If the warning light comes on during operation, check the oil level and fill the oil tank with an 2-stroke engine oil.

The warning light should go off after the 2-stroke engine oil tank has been refilled.

### NOTE:

If the 2-stroke engine oil level warning light does not come on when the key is in the "🔑" position or does not go off after the 2-stroke engine oil tank has been refilled, have a Generic dealer check the electrical circuit.

### CAUTION:

**Do not operate the vehicle until you know that the 2-stroke engine oil level is sufficient. Lack of engine oil will damage the engine.**

## Dashboard unit



1. Speedmeter
2. Odmeter

The dashboard unit is equipped with a speedometer and an odometer. The speedometer shows the riding speed. The odometer shows the total distance traveled.

## Fuel gauge



1. Fuel gauge

The fuel gauge indicates the amount of fuel in the fuel tank. The needle moves towards “E” (Empty) as the fuel level decreases. When the needle reaches “E”, refuel as soon as possible.

### NOTE:

Be take care not let the fuel tank to fully empty it-self, that cause engine can not run it-self anymore.

## Handlebar switches

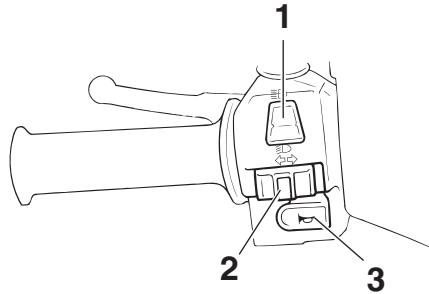

1. Dimmer switch " / "
2. Turn signal switch " "
3. Horn switch " "

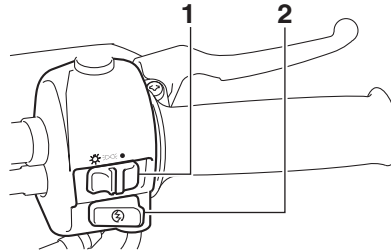

1. Light switch " / / "
2. Start switch " "

## High/Low beam switch " "

Set this switch to " " for the high beam and to " " for the low beam.

## Turn signal switch " "

To signal a right-hand turn, push this switch to " ". To signal a left-hand turn, push this switch to " ". When released, the switch returns to the center position. To cancel the turn signal lights, push the switch in after it has returned to the center position.

## Horn switch " "

Press this switch to sound the horn.

## Light switch " / / "

Turning the light switch to " " turns on the position light, mater light and taillight. Turning the light switch to " ", turns the headlight on also.



# INSTRUMENT AND CONTROL FUNCTIONS

Start switch “”

Push this switch (pull the brake lever at same time to start the engine).

## **⚠ WARNING**

See page 5-1 for starting instructions prior to starting the engine.

Front brake lever

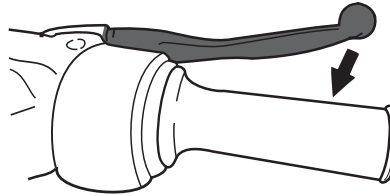

The front brake lever is located on the right handlebar grip. To apply the front brake, pull this lever toward the handlebar grip.

Rear brake lever

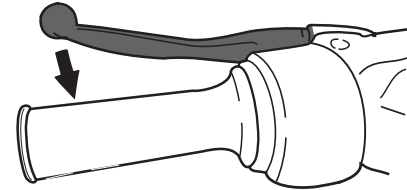

The rear brake lever is located on the left handlebar grip. To apply the rear brake, pull this lever toward the handlebar grip.

## Fuel and 2-stroke engine oil tank caps

The fuel tank cap and the 2-stroke engine oil tank cap are located under the seat. (See page 3-8.)

### Fuel tank cap

#### To remove the fuel tank cap

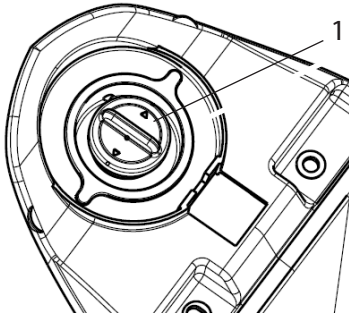

1. Fuel tank cap

#### To remove the fuel tank cap

1. Turn it 1/4 turn counterclockwise. The lock will be released and the fuel tank cap can be removed.

### To install the fuel tank cap

1. Push the fuel tank cap into position
2. Turn the cap clockwise to the original position.

#### **⚠ WARNING**

Make sure that the fuel tank cap is properly closed and locked before riding.

### 2-stroke engine oil tank cap

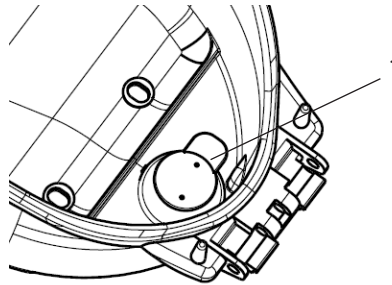

1. 2-stroke engine oil tank cap

To access the 2-stroke engine oil tank, open the storage compartment. (See page 3-8.)

1. Remove the 2-stroke engine oil tank cap by pulling it off.
2. Install the 2-stroke engine oil tank cap by pushing it into the oil tank opening.

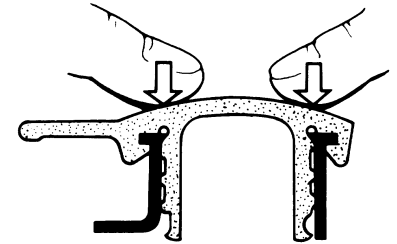

#### NOTE:

Make sure that the 2-stroke engine oil tank cap is properly installed before riding the vehicle.

## Fuel and 2-stroke engine oil

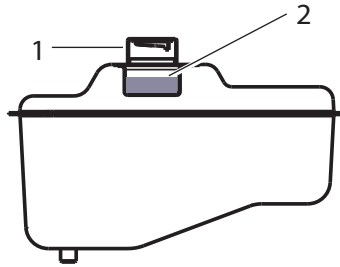

1. Fuel tank filler tube
2. Fuel level

Make sure that there is sufficient fuel in the tank. Fill the fuel tank to the bottom of the filler tube as shown.

### **⚠ WARNING**

- Do not overfill the fuel tank, otherwise it may overflow when the fuel warms up and expands.
- Avoid spilling fuel on the hot engine.

### **CAUTION:**

Immediately wipe off spilled fuel with a clean, dry, soft cloth, since fuel may damage the painted surfaces or plastic parts.

Recommended fuel:  
REGULAR UNLEADED GASOLINE ONLY  
Fuel tank capacity:  
5.5 L

Your Generic engine has been designed to use regular unleaded gasoline of 90 or higher. If knocking (or pinging) occurs, use a gasoline of a different brand or premium unleaded fuel.

### Gasohol

There are two types of gasohol: gasohol containing ethanol and that containing methanol. Gasohol containing ethanol can be used if the ethanol content

does not exceed 10%. Gasohol containing methanol is not recommended by Generic because it can cause damage to the fuel system or vehicle performance problems.

## Catalytic converter

This model is equipped with a catalytic converter in the exhaust system.

### **⚠ WARNING**

The exhaust system is hot after operation. Make sure that the exhaust system has cooled down before doing any maintenance work.

### **CAUTION:**

The following precautions must be observed to prevent a fire hazard or other damages.

- Use only unleaded gasoline. The use of leaded gasoline will cause unreparable damage to the catalytic converter.
- Never park the vehicle near possible fire hazards such as grass or other materials that easily burn.
- Do not allow the engine to idle too long.

## 2-stroke engine oil

Make sure that there is sufficient 2-stroke engine oil in the oil tank. Add the recommended 2-stroke engine oil as necessary.

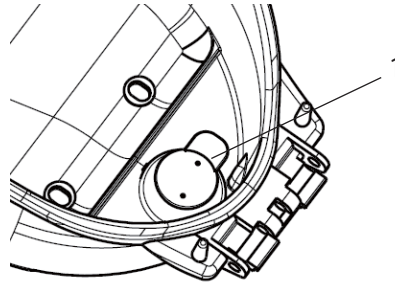

1. 2-stroke engine oil tank cap

Recommended oil:  
(See page 8-1).  
Oil quantity:  
0.85 L

### NOTE:

Make sure that the 2-stroke engine oil tank cap is properly installed.

## Kickstarter

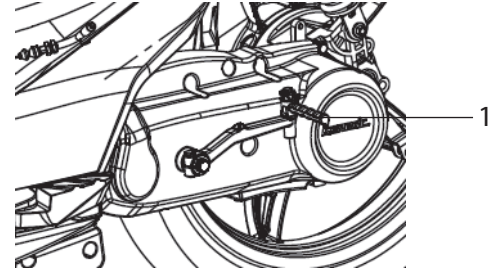

1. Kickstarter lever

To start the engine, fold out the kickstarter lever, move it down lightly with your foot until the gears engage, and then push it down smoothly but forcefully.

## Seat

To open the seat

1. Place the scooter on the centerstand.
2. Insert the key into the main switch, and then turn it counterclockwise to "OPEN".

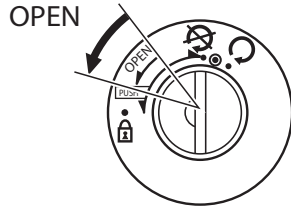

NOTE: \_\_\_\_\_  
Do not push inward when turning the key.  
\_\_\_\_\_

3. Fold the seat up.

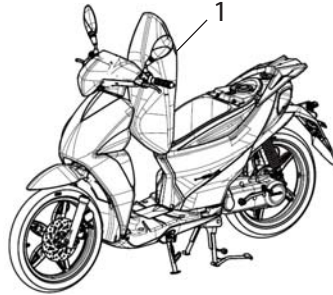

1. Seat

To close the seat

1. Fold the seat down, and then push it down to lock it in place.
2. Remove the key from the main switch if the scooter will be left unattended.

NOTE: \_\_\_\_\_  
Make sure that the seat is properly secured before riding.  
\_\_\_\_\_

## Helmet holder

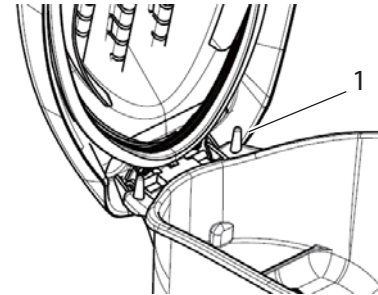

1. Helmet holder

The helmet holder is located under the seat.

To secure a helmet to the helmet holder

1. Open the seat.
2. Attach the helmet to the helmet holder, and then securely close the seat.

## **WARNING** \_\_\_\_\_

Never ride with a helmet attached to the helmet holder, since the helmet may hit objects, causing loss of control and possibly an accident.  
\_\_\_\_\_

To take out the helmet from the helmet holder  
Open the seat, take out the helmet from the helmet holder, and then close the seat.

## Storage Luggage Box

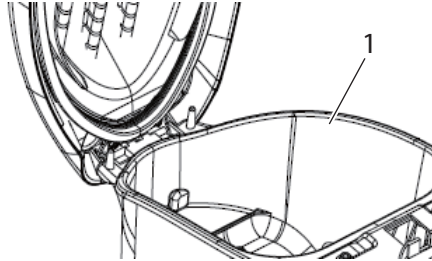

1. Storage luggage box

There is a storage compartment under the seat. (See page 3-8, 3-9)

### **⚠ WARNING**

- Do not exceed the load limit of 2 .5kg for the storage luggage box
- Do not exceed the maximum load of 150 kg for the vehicle.

### **CAUTION:**

Keep the following points in mind when using the storage Luggage Box

- Since the storage luggage box will accumulate heat by the heat of sun and engine, please do not put anything that is sensitive to the heat.
- Since the storage luggage box may get wet while the scooter is being washed, please store the related objects if need with plastic bag to prevent it from getting wet.
- Do not put anything valuable or breakable objects in the storage luggage box

To store a helmet in the storage luggage box, place the helmet upside-down with the front facing forward.

### NOTE:

- Some helmets cannot be stored in the storage luggage box because of their size or shape.
- Before you leave the scooter, make sure the seat is closed firmly

## Front hook, helmet

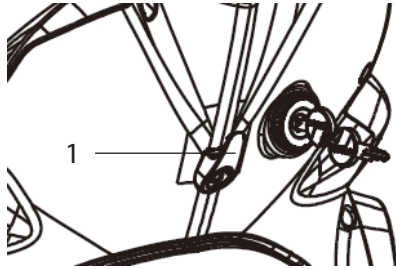

1. Front hook, helmet

### Front hook, helmet

#### **⚠ WARNING**

- Do not exceed the load limit of 1 kg for the front Hook

## Front storage box

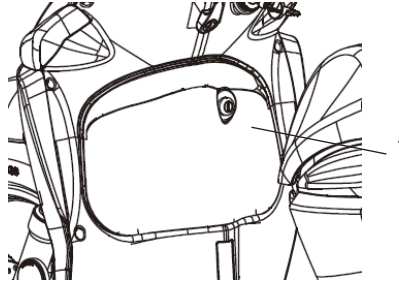

1. Front storage box

To open the front storage box when it is locked, insert the key and turn clockwise direction to open it

To lock the front storage box, put the lid back to the original position, turn it anti-clockwise direction and pull back the key.

#### **⚠ WARNING**

- Do not exceed the load limit of 0.5kg for the front storage box.
- Do not exceed the maximum load of 150 kg for the vehicle.

## Rear Carrier

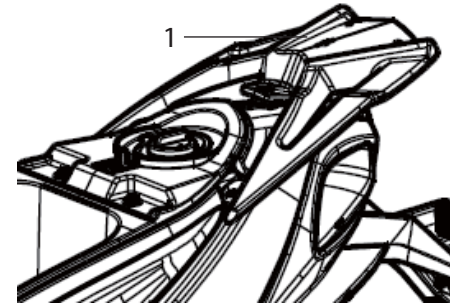

1. Rear Carrier

#### **⚠ WARNING**

- Do not exceed the load limit of 2.5 kg for the carrier.
- Do not exceed the maximum load of 150 kg for the vehicle.

## Shelf front comp (for pizza model)



1. Shelf front comp

### WARNING!!

- Do not exceed the load limit of 5 kg for the shelf front comp.
- Do not exceed the maximum load of 150 kg for the vehicle.

## Sidestand(optional accessories)

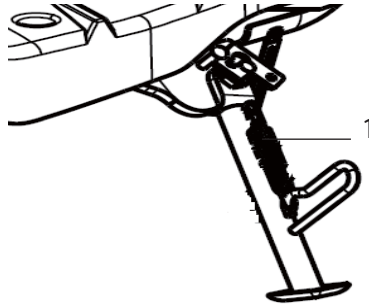

1. Side stand

The side stand is located on the left side of the Vehicle. Release the sidestand by using your feet to step on the bracket of side stand to up-right position to stand the vehicle.

### ⚠ WARNING

- The side stand with auto-rebound system. Make sure your scooter have been park well are stable enough to stand the scooter.
- Please avoid to use side stand to park the scooter on the slope, soft land or un-flat ground.

## Pedal



1. Pedal

The pedal is located on the left side and right side of the vehicle. When you want use it,open the pedal by pulling it .

When you don't want to use it,close the pedal by pushed it and get back to the original position.



## PRE-OPERATION CHECKS

The condition of a vehicle is the owner's responsibility. The operator should check the scooter by simple but thorough inspection, to make sure of scooter condition, quick inspect some key and important parts, to prevent the scooter from serious consequence/accident. Please carefully check the following points before each ride.

NOTE: \_\_\_\_\_  
Pre-operation checks should be made each time the vehicle is used. Such an inspection can be accomplished in a very short time; and the added safety it assures is more than worth the time involved.

---

### **⚠ WARNING**

\_\_\_\_\_

If any item in the Pre-operation check list is not working properly, have it inspected and repaired before operating the vehicle. If failed to be corrected by yourself, please turn to GENERIC repair shop immediately.

---

# PRE-OPERATION CHECKS

## Pre-operation check list

ITEM	CHECKS	PAGE
Fuel	<ul style="list-style-type: none"> <li>• Check fuel level in fuel tank.</li> <li>• Refuel if necessary.</li> <li>• Check fuel line for leakage.</li> </ul>	3-6
2-stroke engine oil	<ul style="list-style-type: none"> <li>• Check oil level in oil tank.</li> <li>• If necessary, add recommended oil to specified level.</li> <li>• Check vehicle for oil leakage.</li> </ul>	3-5
Final transmission oil	<ul style="list-style-type: none"> <li>• Check vehicle for oil leakage.</li> </ul>	6-8
Front brake	<ul style="list-style-type: none"> <li>• Check operation.</li> <li>• If soft or spongy, have Generic dealer bleed hydraulic system.</li> <li>• Check brake pads for wear.</li> <li>• Replace if necessary.</li> <li>• Check fluid level in reservoir.</li> <li>• If necessary, add recommended brake fluid to specified level.</li> <li>• Check hydraulic system for leakage.</li> </ul>	6-14~6-16
Rear brake	<ul style="list-style-type: none"> <li>• Check operation.</li> <li>• Lubricate cable if necessary.</li> <li>• Check lever free play.</li> <li>• Adjust if necessary.</li> </ul>	6-13~6-14
Throttle grip	<ul style="list-style-type: none"> <li>• Make sure that operation is smooth.</li> <li>• Check cable free play.</li> <li>• If necessary, have Generic dealer adjust cable free play and lubricate cable and grip housing.</li> </ul>	6-11, 6-16
Wheels and tires	<ul style="list-style-type: none"> <li>• Check for damage.</li> <li>• Check tire condition and tread depth.</li> <li>• Check air pressure.</li> <li>• Correct if necessary.</li> </ul>	6-12~6-13
Brake levers	<ul style="list-style-type: none"> <li>• Make sure that operation is smooth.</li> <li>• Lubricate lever pivoting points if necessary.</li> </ul>	6-17

# PRE-OPERATION CHECKS

ITEM	CHECKS	PAGE
Main stand	<ul style="list-style-type: none"><li>• Make sure that operation is smooth.</li><li>• Lubricate pivot if necessary.</li></ul>	6-18
Chassis fasteners	<ul style="list-style-type: none"><li>• Make sure that all nuts, bolts and screws are properly tightened.</li><li>• Tighten if necessary.</li></ul>	-
Instruments, lights, signals and switches	<ul style="list-style-type: none"><li>• Check operation.</li><li>• Correct if necessary.</li></ul>	3-2~3-3

# OPERATION AND IMPORTANT RIDING POINTS

## **⚠ WARNING**

- Before riding the scooter, please make sure that you are fully familiar with all operating controls & their functions before riding. To consult a Generic dealer shop if you not thoroughly understand.
- Please do not start the engine in a closed area, the exhaust air are poisonous, and inhaling them can cause loss of consciousness and even death in short time.



## Starting and warming up a cold engine

### **CAUTION:**

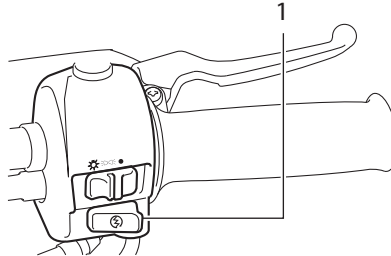
See page 5-4 for engine break-in instructions prior to operating the vehicle for the first time.



1. Engine start switch "  "

1. Turn the key to " , and when the 2-stroke engine oil level warning light comes on, turn the key to "ON .

### **CAUTION:**

If the 2-stroke engine oil level warning light does not come on, have a Generic dealer check the electrical circuit.

3. Close the throttle completely.

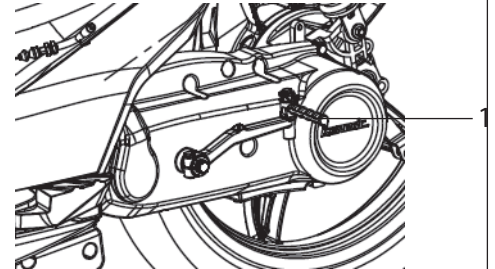

1. Kickstarter lever

4. Start the engine by pushing the start switch or by pushing the kickstarter lever down, while applying the front or rear brake.

### **NOTE:**

If the engine fails to start by pushing the start switch, release the switch, wait a few seconds, and then try again. Each

# OPERATION AND IMPORTANT RIDING POINTS

starting attempt should be as short as possible to preserve the battery. Do not crank the engine more than 5 seconds on any one attempt. If the engine does not start with the starter motor, try using the kickstarter.

## CAUTION:

For maximum engine life, always warm the engine up before starting off. Never throttle hard when the engine is still cold!

## Starting off

NOTE: \_\_\_\_\_  
Before starting off, allow the engine to warm up.

1. While pulling the rear brake lever with your left hand and holding the carrier with your right hand, push the scooter off the main stand.

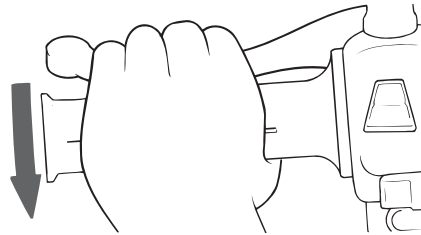

2. Sit astride the seat, and then adjust the rear view mirrors.
3. Switch the turn signal on to the direction you wish to turn.

4. Check for oncoming traffic, and then slowly turn the throttle grip (on the right) in order to take off.
5. Switch the turn signal off.

# OPERATION AND IMPORTANT RIDING POINTS

## Acceleration and deceleration

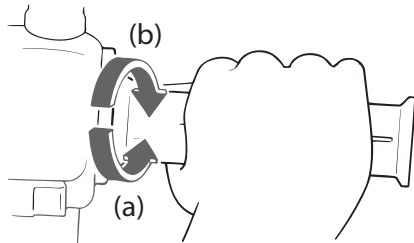

The speed can be adjusted by opening and closing the throttle. To increase the speed, turn the throttle grip in direction (a). To reduce the speed, turn the throttle grip in direction (b).

## Braking

1. Close the throttle completely.
2. Apply both front and rear brakes simultaneously while gradually increasing the pressure.

### FRONT

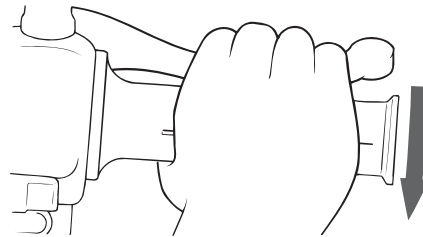

### REAR

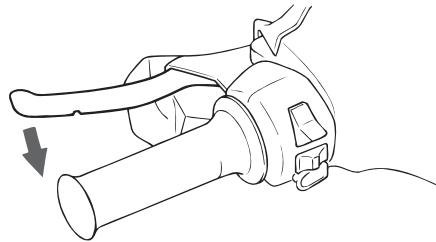

## **⚠ WARNING**

- Avoid braking hard or suddenly, otherwise the scooter may skid.
- Railroad crossings, streetcar rails, iron plates on road construction sites, and manhole covers become extremely slippery when wet. Therefore, slow down when approaching such areas and cross them with caution.
- Keep in mind that braking on a wet road is much more difficult.
- Ride slowly down a hill, as braking downhill can be very difficult.

# OPERATION AND IMPORTANT RIDING POINTS

## Engine break in

There is never a more important period in the life of your engine than the period between 0 and 1000 km. For this reason, you should read the following material carefully.

Since the engine is brand new, do not put an excessive load on it for the first 1000 km. The various parts in the engine wear and polish themselves to the correct operating clearances. During this period, prolonged full-throttle operation or any condition that might result in engine overheating must be avoided.

### 0 ~ 150 km

Avoid prolonged operation above 1/3 throttle. Vary the speed of the scooter from time to time. Do not operate it at one set throttle position.

### 150 ~ 500 km

Avoid prolonged operation above 1/2 throttle.

### 500 ~ 1000 km

Avoid cruising speeds in excess of 3/4 throttle.

**CAUTION:** \_\_\_\_\_

After 1000 km of operation, the final transmission oil must be changed.

### 1000 km and beyond

Avoid prolonged full throttle operation. Vary speeds occasionally.

**CAUTION:** \_\_\_\_\_

If any engine trouble should occur during the engine break-in period, immediately have a Generic dealer check the vehicle.

## Parking

When parking, stop the engine, and then remove the key from the main switch.

**⚠ WARNING** \_\_\_\_\_

- Since the engine and exhaust system can become very hot, park in a place where pedestrians or children are not likely to touch them.
- Do not park on a slope or on soft ground, otherwise the vehicle may overturn.

**CAUTION:** \_\_\_\_\_

Never park in an area where there are fire hazards such as grass or other flammable materials.

# PERIODIC MAINTENANCE AND MINOR REPAIR

Most of the Safety and condition of scooter depend on how you do the correct maintenance, periodic inspection, adjustment and lubrication. The following are contents that help the operator to do such skills on the following pages.

Maintenance, replacement, or repair of the emission control devices and systems may be performed by any repair shop or individual that is certified and must follow the local law regulations.

## WARNING!!

\_\_\_\_\_

If you are not familiar with maintenance work, have a GEBERIC dealer do it for you.

\_\_\_\_\_

## Owner's tool kit

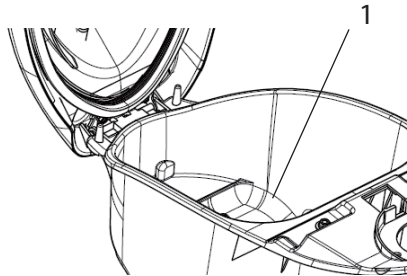

### 1. Owner's tool kit

The owner's tool kit is located inside the rear storage luggage box (See page 3-9.)

The service information included in this manual and the tools provided in the owner's tool kit are intended to assist you in the performance of preventive maintenance and minor repairs. However, additional tools such as a torque wrench may be necessary to perform certain maintenance work correctly.

## NOTE:

\_\_\_\_\_

If you do not have the tools or experience required for a particular job, have a Generic dealer perform it for you.

\_\_\_\_\_

## **⚠ WARNING**

\_\_\_\_\_

Modifications not approved by Generic may cause loss of performance, excessive emissions, and render the vehicle unsafe for use. Consult a Generic dealer before attempting any changes.

\_\_\_\_\_



# PERIODIC MAINTENANCE AND MINOR REPAIR

Periodic maintenance chart for the emission control system

NO.	ITEM	ROUTINE	INITIAL	ODOMETER READING					
			1,000 km	4,000 km	7,000 km	10,000 km	13,000 km	16,000 km	
			or 1 month	or 6 months	or 12 months	or 18 months	or 24 months	or 30 months	
1	* Fuel line	<ul style="list-style-type: none"> <li>• Check fuel and vacuum hoses for cracks or damage.</li> <li>• Replace if necessary.</li> </ul>		√	√	√	√	√	
2	* Idle speed	<ul style="list-style-type: none"> <li>• Check and adjust engine idle speed.</li> </ul>	√	√	√	√	√	√	
3	* Exhaust system	<ul style="list-style-type: none"> <li>• Check for leakage.</li> <li>• Tighten if necessary.</li> <li>• Replace gasket(s) if necessary.</li> </ul>		√	√	√	√	√	
4	* Air induction system	<ul style="list-style-type: none"> <li>• Check the air cut-off valve, reed valve, and hose for damage.</li> <li>• Replace any damaged parts.</li> </ul>		√	√	√	√	√	

\* Since these items require special tools, data and technical skills, have a **Generic** dealer perform the service.

# PERIODIC MAINTENANCE AND MINOR REPAIR

## General maintenance and lubrication chart

NO.	ITEM	ROUTINE	INITIAL	ODOMETER READING					
			1,000 km or 1 month	4,000 km or 6 months	7,000 km or 12 months	10,000 km or 18 months	13,000 km or 24 months	16,000 km or 30 months	
1	* Air filter element	<ul style="list-style-type: none"> <li>• Clean with solvent.</li> <li>• Replace if necessary.</li> </ul>		√	√	√	√	√	
2	* Front brake	<ul style="list-style-type: none"> <li>• Check operation, fluid level, and for fluid leakage.</li> <li>• Replace brake pads if necessary.</li> </ul>	√	√	√	√	√	√	
3	* Rear brake	<ul style="list-style-type: none"> <li>• Check operation.</li> <li>• Adjust cable and replace brake shoes if necessary.</li> </ul>	√	√	√	√	√	√	
4	* Wheels	<ul style="list-style-type: none"> <li>• Check runout and for damage.</li> <li>• Replace if necessary.</li> </ul>		√	√	√	√	√	
5	* Tires	<ul style="list-style-type: none"> <li>• Check tread depth and for damage.</li> <li>• Replace if necessary.</li> <li>• Check air pressure.</li> <li>• Correct if necessary.</li> </ul>		√	√	√	√	√	
6	* Wheel bearings	<ul style="list-style-type: none"> <li>• Check bearings for smooth operation.</li> <li>• Replace if necessary.</li> </ul>		√	√	√	√	√	
7	* Steering bearings	<ul style="list-style-type: none"> <li>• Check bearing assemblies for looseness.</li> <li>• Moderately repack with lithium-soap-based grease every 10000 mi (16000 km) or 18months.</li> </ul>	√	√	√	Repack.	√	√	

# PERIODIC MAINTENANCE AND MINOR REPAIR

NO.	ITEM	ROUTINE	INITIAL	ODOMETER READING					
			1,000 km or 1 month	4,000 km or 6 months	7,000 km or 12 months	10,000 km or 18 months	13,000 km or 24 months	16,000 km or 30 months	
8	* Chassis fasteners	<ul style="list-style-type: none"> <li>• Check all chassis fitting and fasteners.</li> <li>• Correct if necessary.</li> </ul>		√	√	√	√	√	
9	Front brake lever pivot shaft	<ul style="list-style-type: none"> <li>• Apply silicone grease lightly.</li> </ul>		√	√	√	√	√	
10	Rear brake lever pivot shaft	<ul style="list-style-type: none"> <li>• Apply lithium-soap-based grease (all-purpose grease) lightly.</li> </ul>		√	√	√	√	√	
11	Centerstand	<ul style="list-style-type: none"> <li>• Check operation.</li> <li>• Lubricate.</li> </ul>		√	√	√	√	√	
12	* Front fork	<ul style="list-style-type: none"> <li>• Check operation and for oil leakage.</li> <li>• Replace if necessary.</li> </ul>		√	√	√	√	√	
13	* Shock absorber assembly	<ul style="list-style-type: none"> <li>• Check operation and for oil leakage.</li> <li>• Replace if necessary.</li> </ul>		√	√	√	√	√	
14	* Autolube pump	<ul style="list-style-type: none"> <li>• Check operation.</li> <li>• Bleed if necessary.</li> </ul>	√	√	√	√	√	√	
15	Final transmission oil	<ul style="list-style-type: none"> <li>• Check vehicle for oil leakage.</li> <li>• Change.</li> </ul>	√		√		√		
16	* V-belt	<ul style="list-style-type: none"> <li>• R eplace.</li> </ul>	Every 10000 km						
17	* Control and meter cables	<ul style="list-style-type: none"> <li>• Apply Generic chain and cable lube or engine oil 10W-30 thoroughly.</li> </ul>	√	√	√	√	√	√	

# PERIODIC MAINTENANCE AND MINOR REPAIR

NO.	ITEM	ROUTINE	INITIAL	ODOMETER READING					
			1,000 km or 1 month	4,000 km or 6 months	7,000 km or 12 months	10,000 km or 18 months	13,000 km or 24 months	16,000 km or 30 months	
18	*	Throttle grip housing and cable		√	√	√	√	√	√
19	*	Lights, signals and switches	√	√	√	√	√	√	√

\* Since these items require special tools, data and technical skills, have a ~~Generic~~ dealer perform the service.

NOTE: \_\_\_\_\_

From 19000 km or 36 months, repeat the maintenance intervals starting from 7000 km or 12 months.

NOTE: \_\_\_\_\_

- The air filter needs more frequent service if you are riding in unusually wet or dusty areas.
- Hydraulic brake system
  - When disassembling the master cylinder or caliper cylinder, always replace the brake fluid. Check the brake fluid level regularly and fill as required.
  - Replace the brake hoses every four years or if cracked or damaged.

\_\_\_\_\_

# PERIODIC MAINTENANCE AND MINOR REPAIR

## Removing and installing the battery cover and center cover

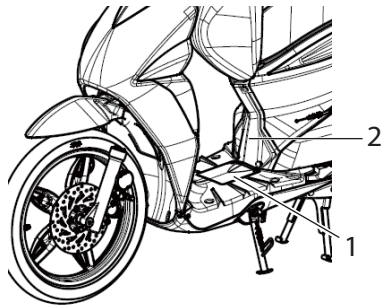

1. Battery cover 2.Center cover

The covers shown needs to be removed to perform some of the maintenance jobs described in this chapter.

### Battery cover

(To remove the cover)

Remove the screws, and then take the cover off.

(To install the cover)

Place the cover in the original position, and then install the screws.

Center cover

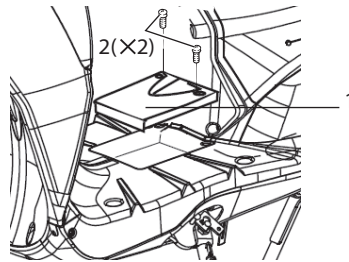

1. Battery cover
2. Screw

(To remove the cover)

Remove the screws, and then take the cover off.

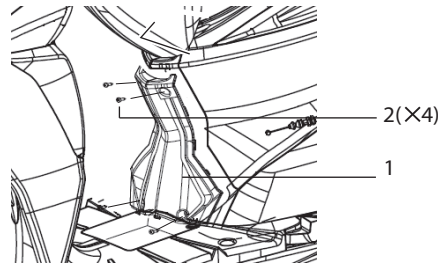

1. Center cover
2. Screw

(To install the cover)

Place the cover in the original position, and then install the screws.

## Checking the spark plug

The spark plug is an important engine component, which is easy to check. Since heat and deposits will cause any spark plug to slowly erode, the spark plug should be removed and checked in accordance with the periodic maintenance and lubrication chart. In addition, the condition of the spark plug can reveal the condition of the engine.

To remove the spark plug

1. Remove cover. (See page 6-7)
2. Remove the spark plug cap.

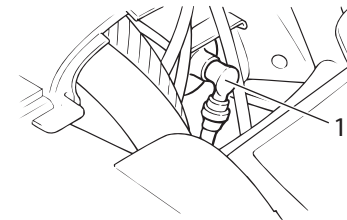

1. Spark plug cap

# PERIODIC MAINTENANCE AND MINOR REPAIR

3. Remove the spark plug as shown, with the spark plug wrench included in the owner's tool kit.

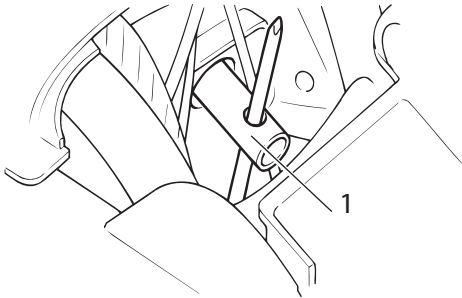

1. Spark plug wrench

## To check the spark plug

1. Check that the porcelain insulator around the center electrode of the spark plug is a medium-to-light tan (the ideal color when the vehicle is ridden normally).

NOTE: \_\_\_\_\_  
If the spark plug shows a distinctly different color, the engine could be operating improperly. Do not attempt to diagnose such problems yourself. Instead, have a **Genie** dealer check the vehicle.

2. Check the spark plug for electrode erosion and excessive carbon or other deposits, and replace it if necessary.

Specified spark plug:  
BR8HSA (NGK)

## To install the spark plug

1. Measure the spark plug gap with a wire thickness gauge and, if necessary, adjust the gap to specification.

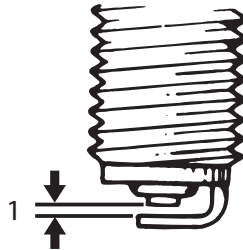

1. Spark plug gap

Spark plug gap:  
0.6 ~ 0.7 mm

2. Clean the surface of the spark plug gasket and its mating surface, and then wipe off any grime from the spark plug threads.
3. Install the spark plug with the spark plug wrench, and then tighten it to the specified torque.

Tightening torque:  
Spark plug:  
18 Nm

NOTE: \_\_\_\_\_  
If a torque wrench is not available when installing a spark plug, a good estimate of the correct torque is 1/4 ~ 1/2 turn past finger tight. However, the spark plug should be tightened to the specified torque as soon as possible.

4. Install the spark plug cap.
5. Install the panel.

# PERIODIC MAINTENANCE AND MINOR REPAIR

## Final transmission oil

The final transmission case must be checked for oil leakage before each ride. If any leakage is found, have a Generic dealer check and repair the scooter. In addition, the final transmission oil must be changed as follows at the intervals specified in the periodic maintenance and lubrication chart.

1. Start the engine, warm up the final transmission oil by riding the scooter for several minutes, and then stop the engine.
2. Place the scooter on the main stand.
3. Place an oil pan under the final transmission case to collect the used oil.
4. Remove the oil filler cap and drain bolt to drain the oil from the final transmission case.

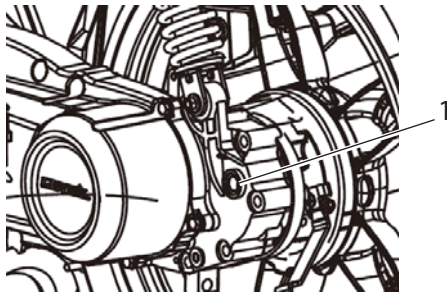

1. Final transmission oil filler cap

5. Install the final transmission oil drain bolt, and then tighten it to the specified torque.

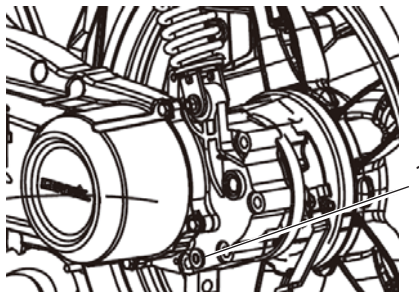

1. Final transmission oil drain bolt

Tightening torque:  
Final transmission oil drain bolt:  
18 Nm

6. Add the requested amount of the recommended final transmission oil, and then install and tighten the oil filler cap.

Recommended final transmission oil:  
Castrol MTX Part Snth. 80W od. EP 80W-90  
(See page 8-1).  
Oil quantity:  
Full: 0.13L/ Change: 0.11 L

### WARNING!!

- Make sure that no foreign material enters the final transmission case.
- Make sure that no oil gets on the tire or wheel.

7. Check the final transmission case for oil leakage. If oil is leaking, check for the cause.

# PERIODIC MAINTENANCE AND MINOR REPAIR

## Cleaning the air filter element

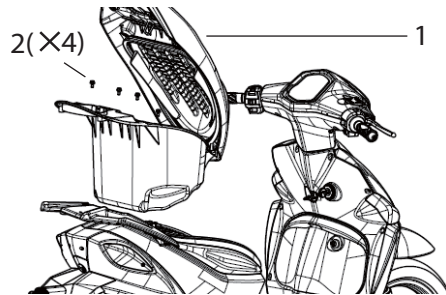

1. Seat&storage compartment
2. Bolt

The air filter element should be cleaned at the intervals specified in the periodic maintenance and lubrication chart. Clean the air filter element more frequently if you are riding in unusually wet or dusty areas.

1. Open the seat (See page 3-8)
2. Remove the Fuel tank cap and oil tank cap(See page 3-5)
3. Remove the seat and storage luggage box by removing the bolt.
4. Remove the air filter band .



1. Band
2. Screw



1. Air filter case
2. Screw

5. Remove air filter case by removing the screws on the crankcase side.
6. Remove the air filter case cover by removing the screws.



1. Air filter case cover
2. Screw



1. Air filter element

7. Pull the air filter element out.
8. Clean the air filter element with solvent, and then squeeze the remaining solvent out.



# PERIODIC MAINTENANCE AND MINOR REPAIR

## WARNING!!

Use only a dedicated parts cleaning solvent. To avoid the risk of fire or explosion, do not use gasoline or solvents with a low flash point.

## CAUTION:

To avoid damaging the air filter element, handle it gently and carefully, and do not twist it.

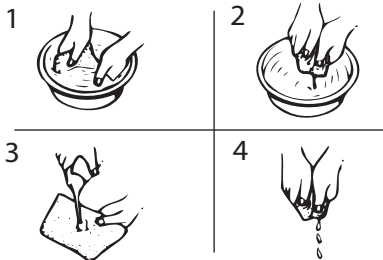

7. Apply oil of the recommended type to the entire surface of the air filter element, and then squeeze the excess oil out.

## NOTE:

The air filter element should be wet but not dripping.

Recommended oil:  
2-stroke engine oil

8. Coat the mating surfaces of the air filter case and air filter case cover lightly with grease for an airtight seal.
9. Install the air filter element.
10. Install the air filter case cover by installing the screws.
11. Install the air filter case by installing the screws, and then install the air filter joint band.
12. Install the the set and storage compartment by installing the bolt.
13. Install the Fuel tank cap and oil tank cap(See page 3-5)
14. Close the seat.

## CAUTION:

- Make sure that the air filter element is properly seated in the air filter case.
- The engine should never be operated without the air filter element installed, otherwise the piston and/or cylinder may become excessively worn.

## Carburetor

The carburetor is an important part of the engine and its emission control system, which requires very sophisticated adjustment. Therefore, carburetor adjustments should be left to Generic dealer, who has the necessary professional knowledge and experience.

## Checking the throttle cable free play

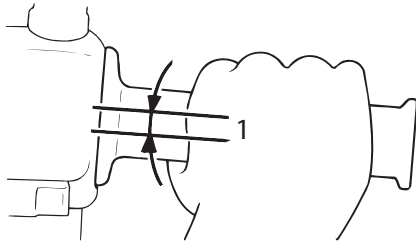

### 1. Throttle cable free play

The throttle cable free play should measure 1.5 ~ 3.5 mm at the throttle grip. Periodically check the throttle cable free play and, if necessary, have a Generic dealer adjust it.

## Tires

To maximize the performance, durability, and safe operation of your scooter, note the following points regarding the specified tires.

### Tire air pressure

The tire air pressure should be checked and, if necessary, adjusted before each ride.

#### WARNING!!

- The tire air pressure must be checked and adjusted on cold tires (i.e., when the temperature of the tires equals the ambient temperature).
- The tire air pressure must be adjusted in accordance with the riding condition. If you are not familiar to this, please have Generic dealer for help.

Tire air pressure (measured on cold tires):

Front:  
235 kPa

Rear:  
235 kPa

Maximum load\*:  
150 kg

\* Total weight of rider, passenger, cargo and accessories

#### WARNING!!

- Do not over load your scooter, since it will increase pressure on the tire, braking, steering than original design, and may could cause damage or even lead to accident.
- Allocation of your cargo and weight of your vehicle is very important for your own safety and vehicle performance. Load your cargo firmly on vehicle and put the heaviest cargo to the center of scooter, then distribute the weight evenly from side to side. It will keep you to have good steering after load.

# PERIODIC MAINTENANCE AND MINOR REPAIR

## Tire inspection

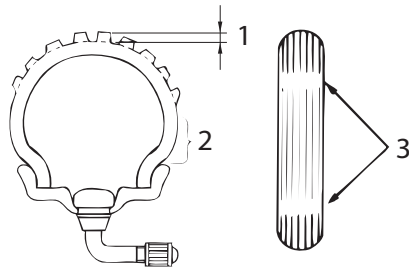

1. Tire tread depth
2. Tire sidewall
3. Tire wear indicator

The tires must be checked before each ride. If a tire tread shows crosswise lines (minimum tread depth), if the tire has a nail or glass fragments in it, or if the

sidewall is cracked, have a Generic dealer replace the tire immediately.

Minimum tire tread depth (front and rear):

Front : 1.6 mm  
Rear: 2.0mm

### NOTE:

The tire tread depth limits may differ from country to country. Always comply with the local regulations.

### Tire information

This scooter is equipped with cast wheels and tubeless tires with valves.

### WARNING!!

Operating the scooter with excessively worn tires decrease riding stability and can lead to loss of control. Please replace the excessive worn tires by a Generic dealer immediately. Brakes, tires, and related wheel parts replacement should be left to a Generic Service Technician.

### Front tire:

Size:

80/80-16 46J

Manufacturer/model:

KENDA/K488

### Rear tire:

Size:

90/80-16 52J

Manufacturer/model:

KENDA/K488

## Cast wheels

To maximize the performance, durability, and safe operation of your motorcycle, note the following points regarding the specified wheels.

- The wheel rims should be checked for cracks, bends or warpage before each ride. If any damage is found, have a **Generic** dealer replace the wheel. Do not attempt even the smallest repair to the wheel. A deformed or cracked wheel must be replaced.
- The wheel should be balanced whenever either the tire or wheel has been changed or replaced. An unbalanced wheel can result in poor performance, adverse handling characteristics, and a shortened tire life.
- Ride at moderate speeds after changing a tire since the tire surface must first be “broken in” for it to develop its optimal characteristics.

## Checking the front brake lever free play

There should be no free play at the brake lever end. If there is free play, have a **Generic** dealer inspect the brake system.

### WARNING!!

A soft or spongy feeling in the brake lever can indicate the presence of air in the hydraulic system. If there is air in the hydraulic system, have a **Generic** dealer bleed the system before operating the motorcycle. Air in the hydraulic system will diminish the braking performance, which may result in loss of control and an accident.

## Adjusting the rear brake lever free play

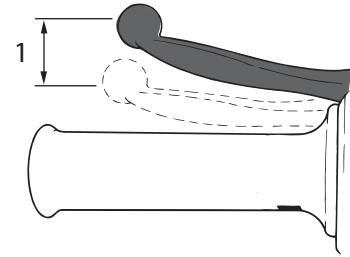

### 1. Rear brake lever free play

The brake lever free play should measure 10~20 mm as shown. Periodically check the brake lever free play and, if necessary, adjust it as follows.

To increase the brake lever free play, turn the adjusting nut at the brake shoe plate in direction (a). To decrease the brake lever free play, turn the adjusting nut in direction (b).

# PERIODIC MAINTENANCE AND MINOR REPAIR

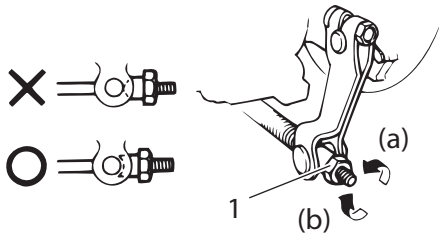

1. Adjusting nut

## WARNING!!

If proper adjustment cannot be obtained as described, have a Generic dealer make this adjustment.

## Checking the front brake pads and rear brake shoes

The front brake pads and the rear brake shoes must be checked for wear at the intervals specified in the periodic maintenance and lubrication chart.

### Front brake pads

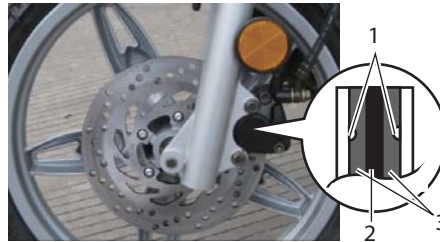

1. Wear indicator
2. Brake disc
3. Brake pad

Each front brake pad is provided with wear indicators, which allows you to check the brake pad wear without having to disassemble the brake. To check the brake pad wear, check the position

of the wear indicators while applying the brake. If a brake pad has worn to the point that a wear indicator almost touches the brake disc, have a Generic dealer replace the brake pads as a set.

### Rear brake shoes

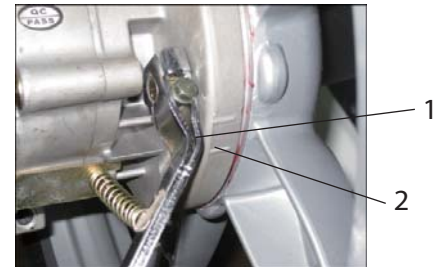

1. Wear indicator
2. Wear limit line

The rear brake is provided with a wear indicator, which allows you to check the brake shoe wear without having to disassemble the brake. To check the brake shoe wear, check the position of the wear indicator while applying the brake. If a brake shoe has worn to the point that the wear indicator reaches the wear

# PERIODIC MAINTENANCE AND MINOR REPAIR

limit line, have a **Generic** dealer replace the brake shoes as a set.

## Checking the front brake fluid level

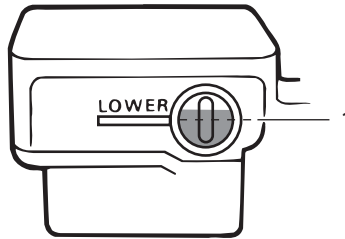

1. Minimum level mark

Insufficient brake fluid may allow air to enter the brake system, possibly causing it to become ineffective. Before riding, check that the brake fluid is above the minimum level mark and refill it if necessary. Low position brake fluid level may indicate worn brake pads and/or brake system leakage. If the brake fluid level is low, be sure to check the brake pads for wear and the brake system for leakage.

Observe these precautions:

- When checking the fluid level,

make sure that the top of the master cylinder is level by turning the handlebars.

- Use only the recommended quality brake fluid, otherwise the rubber seals may deteriorate, causing leakage and poor braking performance.

Recommended brake fluid:  
DOT 3/4

- Refill with the same type of brake fluid. Mixing fluids may result in a harmful chemical reaction and lead to poor braking performance.
- Be careful that water does not enter the master cylinder when refilling. Water will significantly lower the boiling point of the fluid and may result in vapor lock.
- Brake fluid may deteriorate painted surfaces or plastic parts. Always clean up spilled fluid immediately.
- As the brake pads wear, it is normal for the brake fluid level to gradually go down. However, if the brake fluid level goes down suddenly, have a **Generic** dealer check.

## PERIODIC MAINTENANCE AND MINOR REPAIR

### Changing the brake fluid

Have a Generic dealer change the brake fluid at the intervals specified in the NOTE after the periodic maintenance and lubrication chart.

### Checking and lubricating the cables

The operation of all control cables and the condition of the cables should be checked before each ride, and the cables and cable ends should be lubricated if necessary. If a cable is damaged or does not move smoothly, have a Generic dealer check or replace it.

Recommended lubricant:  
engine oil SAE 10W-30

### **⚠ WARNING**

Damage to the outer housing of cables may result in internal rusting and cause interference with cable movement. Replace damaged cables as soon as possible to prevent unsafe conditions.

### Checking and lubricating the throttle grip and cable

The operation of the throttle grip should be checked before each ride. In addition, the cable should be lubricated at the intervals specified in the periodic maintenance chart.

# PERIODIC MAINTENANCE AND MINOR REPAIR

## Adjusting the Autolube pump

The Autolube pump is a vital and sophisticated component of the engine, which must be adjusted by a Generic dealer at the intervals specified in the periodic maintenance and lubrication chart.

## Lubricating the front and rear brake levers

Front brake lever

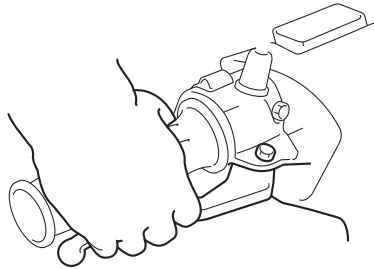

Rear brake lever

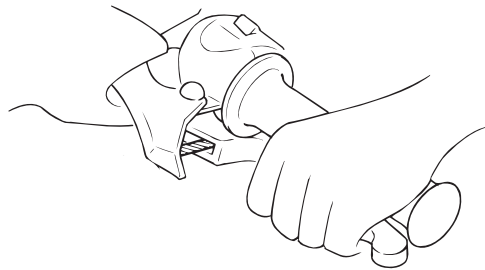

The pivoting points of the front and rear brake levers must be lubricated at the intervals specified in the periodic maintenance and lubrication chart.

Recommended lubricants:

Front brake lever:

Silicone grease

Rear brake lever:

Lithium-soap-based grease  
(all-purpose grease)



# PERIODIC MAINTENANCE AND MINOR REPAIR

## Checking and lubricating the Main stand

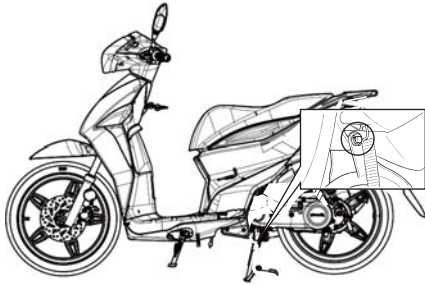

The operation of the main stand should be checked before each ride, and the pivots and metal-to-metal contact surfaces should be lubricated if necessary.

### **⚠ WARNING**

If the main stand does not move up and down smoothly, have a Generic dealer check or repair it.

Recommended lubricant:  
Lithium-soap-based grease (all-purpose grease)

## Checking the front fork

The condition and operation of the front fork must be checked as follows at the intervals specified in the periodic maintenance and lubrication chart.

To check the condition

### **⚠ WARNING**

Securely support the motorcycle so that there is no danger of it falling over.

Check the inner tubes for scratches, damage and excessive oil leakage.

To check the operation

1. Place the motorcycle on a level surface and hold it in an upright position.
2. While applying the front brake, push down hard on the handlebars several times to check if the front fork compresses and rebounds smoothly.

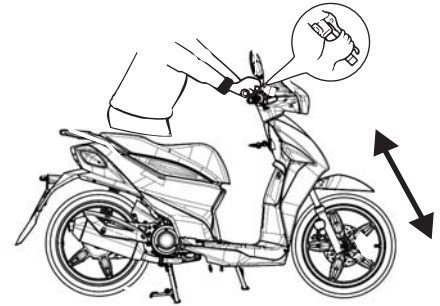

### **CAUTION:**

If any damage is found or the front fork does not operate smoothly, have a Generic dealer check or repair it.

## Checking the steering

Worn or loose steering bearings may cause danger. Therefore, the operation of the steering must be checked as follows at the intervals specified in the periodic maintenance and lubrication chart.

1. Place a stand under the engine to raise the front wheel off the ground.

### **⚠ WARNING**

Securely support the motorcycle so that there is no danger of it falling over.

2. Hold the lower ends of the front fork legs and try to move them forward and backward. If any free play can be felt, have a Generic dealer check or repair the steering.

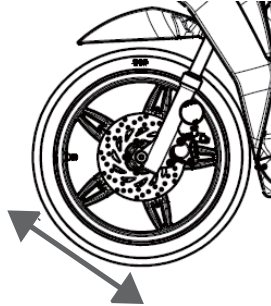

## Checking the wheel bearings

The front and rear wheel bearings must be checked at the intervals specified in the periodic maintenance and lubrication chart. If there is play in the wheel hub or if the wheel does not turn smoothly, have a Generic dealer check the wheel bearings.

# PERIODIC MAINTENANCE AND MINOR REPAIR

## Battery

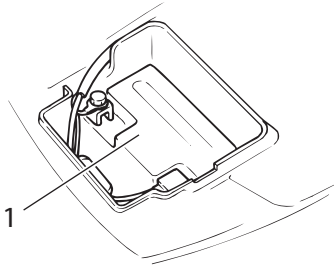

### 1. Battery

The battery is located behind battery cover. (See page 6-6.)

This model is equipped with a sealed-type (MF) battery, which does not require any maintenance. There is no need to check the electrolyte or to add distilled water.

#### CAUTION:

Never attempt to remove the battery cell seals, as this would permanently damage the battery.

#### ⚠ WARNING

- Electrolyte is poisonous and dangerous since it contains sulfuric acid, which causes severe burns. Avoid any contact with skin, eyes or clothing and always shield your eyes when working near batteries. In case of contact, administer the following FIRST AID.
  - EXTERNAL: Flush with plenty of water.
  - INTERNAL: Drink large quantities of water or milk and immediately call a physician.
  - EYES: Flush with water for 15 minutes and seek prompt medical attention.
- Batteries produce explosive hydrogen gas. Therefore, keep sparks, flames, cigarettes, etc., away from the battery and provide sufficient ventilation when charging it in an enclosed space.
- KEEP THIS AND ALL BATTERIES OUT OF THE REACH OF

#### CHILDREN.

To charge the battery  
Have a **Generic** dealer charge the battery as soon as possible if it seems to have discharged. Keep in mind that the battery tends to discharge more quickly if the vehicle is equipped with optional electrical accessories.

To store the battery

1. If the vehicle will not be used for more than one month, remove the battery, fully charge it, and then place it in a cool, dry place.
2. If the battery will be stored for more than two months, check it at least once a month and fully charge it if necessary.
3. Fully charge the battery before installation.
4. After installation, make sure that the battery leads are properly connected to the battery terminals.

#### CAUTION:

- Always keep the battery charged. Storing a discharged

# PERIODIC MAINTENANCE AND MINOR REPAIR

battery can cause permanent battery damage.

- To charge the battery, please make sure the amper and volts of charger that suitable to the MF battery and the specific type. If you do not familiar to the battery charging, please have a Generic dealer to charge your battery.

## Replacing the fuse

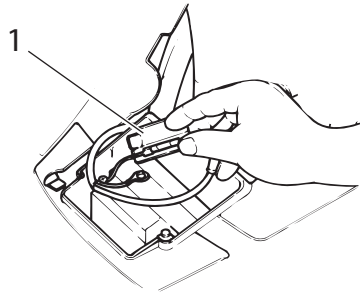

1. Fuse

The fuse holder is located behind battery cover. (See page 6-7.)

If the fuse is blown, replace it as follows.

1. Turn the key to "⊗" and turn off all electrical circuits.
2. Remove the blown fuse, and then install a new fuse of the specified amperage.

Specified fuse:  
10 A

### CAUTION:

Do not use a fuse of a higher amperage rating than recommended to avoid causing extensive damage to the electrical system and possibly a fire.

3. Turn the key to "○" and turn on the electrical circuits to check if the devices operate.
4. If the fuse immediately blows again, have a Generic dealer check the electrical system.

# PERIODIC MAINTENANCE AND MINOR REPAIR

## Replacing a headlight bulb

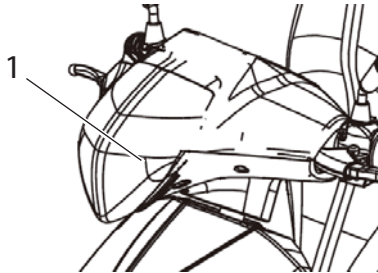

1. Headlight

This model is equipped with halogen bulb headlight. If a headlight bulb burns out, have a Generic dealer replace it and, if necessary, adjust the headlight beam.

## Front turn signal light

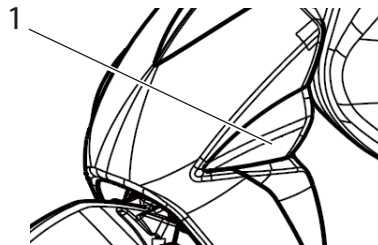

1. Front turn signal light

If the turn signal light bulb does not come on, have a Generic dealer check its electrical circuit or replace the bulb.

## Replacing rear turn signal light bulb

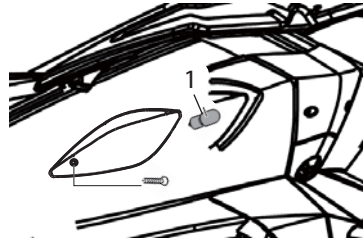

1. Turn signal light bulb

1. Remove the turn signal light lens by remove the screw .
2. Remove the burnt-out bulb by pushing it in and turning it counterclockwise.
3. Insert a new bulb into the socket, push it in, and then turn it clockwise until it stops.
4. Install the lens by installing the screw.

## Tail/brake light and license light

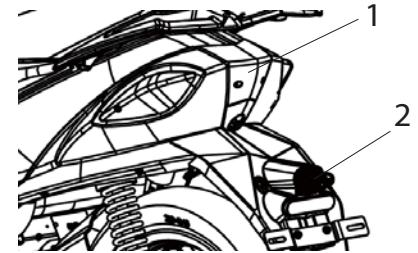

1. Tail/brake light
2. License light

If the tail/brake light and license light bulb does not come on, have a Generic dealer check its electrical circuit or replace the bulb.

# PERIODIC MAINTENANCE AND MINOR REPAIR

## (FOR PIZZA MODEL) Replacing a headlight bulb

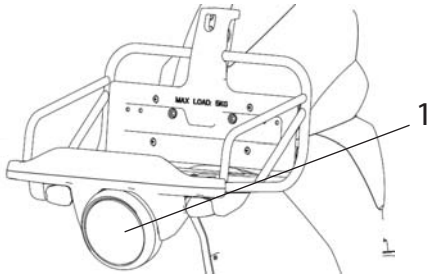

### 1. Headlight

This model is equipped with halogen bulb headlight. If a headlight bulb burns out, have a Generic dealer replace it and, if necessary, adjust the headlight beam.

## (FOR PIZZA MODEL) Front turn signal light

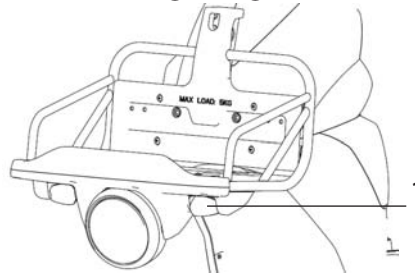

### 1. Front turn signal light

If the turn signal light bulb does not come on, have a Generic dealer check its electrical circuit or replace the bulb.

## Troubleshooting

Although Generic scooters receive a thorough inspection before shipment from the factory, trouble may occur during operation. Any problem in the fuel, compression, or ignition systems, for example, can cause poor starting and loss of power.

The following troubleshooting chart represents a quick and easy procedure for checking these vital systems yourself.

However, should your scooter require any repair, take it to a Generic dealer, whose skilled technicians have the necessary tools, experience, and know-how to service the scooter properly. Use only genuine Generic replacement parts. Imitation parts may look like Generic parts, but they are often inferior, have a shorter service life and can lead to expensive repair bills.

# PERIODIC MAINTENANCE AND MINOR REPAIR

## Troubleshooting chart

### **⚠ WARNING**

Keep away open flames and do not smoke while checking or working on the fuel system.

### 1. Fuel

Check the fuel level in the fuel tank.

There is enough fuel.

→ Check the compression.

There is no fuel.

→ Supply fuel.

→ The engine does not start.  
Check the compression.

### 2. Compression

Operate the electric starter.

There is compression.

→ Check the ignition.

There is no compression.

→ Have a Generic dealer check the vehicle.

### 3. Ignition

Remove the spark plug and check the electrodes.

Wet

→ Wipe off with a dry cloth and correct the spark plug gaps, or replace the spark plug.

→ Operate the electric starter.

Dry

→ Have a Generic dealer check the vehicle.

↓  
The engine does not start.  
Check the battery.

### 4. Battery

Operate the electric starter.

The engine turns over quickly.

→ The battery is good.

The engine turns over slowly.

→ Check the battery lead connections, and charge the battery if necessary.

→ The engine does not start.  
Have a Generic dealer check the vehicle.

## Clean the Scooter

Clean of the scooter in proper and suitable way will make it attractive, extend it's life and optimize the performance.

### Before cleaning

1. Cover the muffler outlet with a plastic bag to prevent water to come inside. Please do it only after the engine/muffler in cool status.
2. Closed every caps, covers, electrical connectors that are well install and water can be avoid to get into, while you do the clean job.

### CAUTION:

- Generic do not suggest to use the acidic cleaners for cleaning , but ff such products have to been used on hard-to-remove dirt, please only do the spot cleaning and use water, dry it and corrosion protection spray after finish.
- Please only use mild detergent and water to clean plastic covers, panels, windshields, headlight lenses, meter lenses, etc. After

cleaning, use only a soft, clean cloth or Spinge to dry the plastics.

- Please prevent any harsh chemical products (like fuel, rusty removers, break fluid...) on plastic parts, especially on painted covers, lens and wind shield. it will damage/un-function them, and even cause safety consideration.
- Do not use high-pressure washer, steam cleaner since it will cause water seepage and deterioration on axle bearings, electric components as connectors and switches, lights, breathe hose and tube, brake shoes and pads and seals, due to the pressure and heat.
- For scooters equipped with a windshield: Do not use strong cleaners or hard sponges as they will cause blur or scratch. Only wash it by gentle water and mild detergent.

### After normal use

Remove dirt with warm water, a mild detergent, and a soft, clean sponge, and then rinse thoroughly with clean water. Use a toothbrush or bottlebrush for hard-to-reach areas.

### After riding in the rain, near the sea or on salt-sprayed roads

Since sea salt or salt sprayed on the roads during winter are extremely corrosive in combination with water, carry out the following steps after each ride in the rain, near the sea or on salt-sprayed roads.

### NOTE:

Salt sprayed on roads in the winter may remain exist into spring.

1. Clean the scooter with cold water and a mild detergent after the engine has cooled down.



**CAUTION:**

Do not use warm water since it increases the corrosive action of the salt.

2. Apply a corrosion protection spray on all metal, including chrome- and nickel-plated, surfaces to prevent corrosion.

**After cleaning**

1. Dry the scooter with a absorbing cloth.
2. To prevent corrosion, it is recommended to apply a corrosion protection spray on all metal, including chrome- and nickel-plated, surfaces.
3. Use spray oil as a universal cleaner to remove any remaining dirt.
4. Wax all painted surfaces.
5. Dry the scooter completely if need to cover it.

**WARNING!!**

- Make sure that there is no oil or wax on the brakes or tires. If necessary, clean the brake discs and brake linings with a regular brake disc cleaner and wash the tires with warm water and a mild detergent.
- Before operating the scooter, test the braking performance and tires.

**NOTE:**

Consult a **Generic** dealer for advice on what products to use.

**Storage****Short-term**

Always store your scooter in a cool, dry place and, if necessary, protect it against dust with a scooter cover.

**CAUTION:**

- Please store the scooter in a well air flow room with dry air if possible. A place with wet humidity will cause rust.
- To prevent corrosion, avoid damp cellars, stables (because of the presence of ammonia) and areas where strong chemicals are stored.

**Long-term**

Before storing your scooter for several months:

1. Follow all the instructions in the "Clean" section of this chapter.
2. Drain out the fuel from the carburetor float chamber by loosening the drain bolt. It will prevent fuel deposits and cause the hard engine start afterward. Pour the drained fuel into the fuel tank.

## SCOOTER CARE AND STORAGE

3. Fill up the fuel tank and add fuel stabilizer (if available) to prevent the fuel tank from rusting and the fuel from deteriorating.
4. Perform the following steps to protect the cylinder, piston rings, etc. from corrosion.
  - a. Remove the spark plug cap and spark plug.
  - b. Pour a teaspoonful of engine oil into the spark plug bore.
  - c. Install the spark plug cap onto the spark plug, and then place the spark plug on the cylinder head so that the electrodes are grounded. (This will limit sparking during the next step.)
  - d. Turn the engine over several times with the starter. (This will coat the cylinder wall with oil.)
  - e. Remove the spark plug cap from the spark plug, and then install the spark plug and the spark plug cap.

### WARNING!!

\_\_\_\_\_

To prevent damage or injury from sparking, make sure to ground the

spark plug electrodes while turning the engine over.

---

5. Lubricate all control cables and the pivoting points of all levers and pedals as well as of the side stand/main stand.
6. Check and, if necessary, correct the tire air pressure, and then lift the scooter so that both of its wheels are off the ground. Alternatively, turn the wheels a little every month in order to prevent the tires from becoming degraded in one spot.
7. Cover the muffler outlet with a plastic bag to prevent moisture from entering it.
8. Remove the battery and fully charge it. Store it in a cool, dry place and charge it once a month. Do not store the battery in an excessively cold or warm place [less than 0 °C (30 °F) or more than 30 °C (90 °F)]. For more information on storing the battery, see page 6-21.

NOTE: \_\_\_\_\_  
Make any necessary repairs before storing the scooter.

---

## Dimensions

(Weight 120 kg)

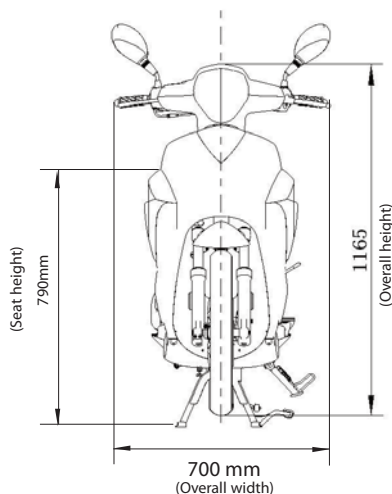
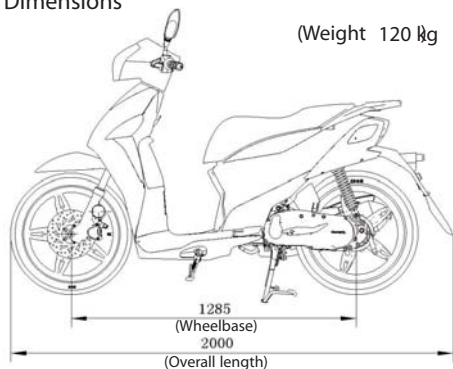

## Engine

Engine type  
Air cooled 2-stroke  
Cylinder arrangement  
Forward-inclined single cylinder  
Displacement  
49.0 cm<sup>3</sup>  
Compression ratio  
6.9:1(45Km)5.9:1(25Km)  
Starting system  
Electric starter and kickstarter"  
Lubrication system  
Separate lubrication  
2-stroke engine oil

## Engine oil quantity

Quantity 0.85 L  
recommended type:  
Castrol Power 1 Racing 2T

## Transmission oil

Type SAE 85W140  
Oil change quantity 0.11 L  
recommended type:  
Castrol MTX Part Snth. 80W od.  
EP 80W-90

## Air filter

Air filter element  
Wet element

## Fuel

Recommended fuel  
Regular unleaded gasoline Otane No. 90  
or above  
Fuel tank capacity  
5.5L

## Carburetor

Manufacturer (QJ)  
Type x quantity  
PZ19JB-2K x 1

## Spark plug (s)

Manufacturer/model  
NGK/BR8HSA  
Spark plug gap  
0.6-0.7 mm

## Clutch

Clutch type  
Dry, centrifugal automatic  
Transmission type  
V-belt automatic  
Operation  
Centrifugal automatic type

## Chassis

Frame type  
Steel tube backbone

## Front tire

Type  
Tubeless  
Size  
80/80-16 46J  
Manufacturer/model  
KENDA / K-488

## Rear tire

Type  
Tubeless  
Size  
90/80-16 52J  
Manufacturer/model  
KENDA / K-488

## Tire air pressure (measured on cold tires)

Front  
280 kPa  
Rear  
280 kPa

## Front wheel

Wheel type  
Cast wheel  
Rim size  
16 x 1.6

## Rear wheel

Wheel type  
Cast wheel  
Rim size  
16 x 1.85

## Front brake

Type  
Single disc brake  
Operation  
Right hand operation  
Recommended fluid  
DOT 3 or 4  
(CASTROL SUPER DISK BRAKE  
FLUID DOT 4.)

## Rear brake

Type  
Drum brake  
Operation  
Left hand operation

## Front suspension

Type  
Telescopic fork  
Spring/shock absorber type  
Coil spring/oil damper

## Rear suspension

Type  
Unit swing  
Spring/shock absorber type  
Coil spring/oil damper

## Electrical system

Ignition system  
CDI  
Charging system  
CDI magneto

## Battery

Model  
YTX4L-BS  
Voltage, capacity  
12 V, 4.0 Ah

## Headlight

Bulb type  
Halogen bulb

## Bulb voltage, wattage x quantity

Headlight  
12 V, 35 W/35.0 W x 1  
Tail/brake light  
12 V, 5.0 W/21.0 W x 1  
Front turn signal light  
12 V, 21.0 W x 2

## Rear turn signal light

12 V, 10.0 W x 2  
License plate light  
12 V, 5.0 W x 1  
Meter lighting  
12 V, 2 W x 1  
Meter lighting (fuel meter)  
12 V, 2 W x 1  
High beam indicator light  
12 V, 2W x 1  
Oil level warning light  
12 V, 3 W x 1  
Turn signal indicator light  
12 V, 3 W x 1

## Fuses

Main fuse  
10.0 A

## Identification numbers

Record the key identification number, vehicle identification number and model label information in the spaces provided below for assistance when ordering spare parts from a ~~Generic~~ dealer or for reference in case the vehicle is stolen.

KEY IDENTIFICATION NUMBER:

VEHICLE IDENTIFICATION NUMBER:

## Key identification number



1. Key identification number

The key identification number is stamped into the key tag. Record this number in the space provided and use it for reference when ordering a new key.

## Vehicle identification number

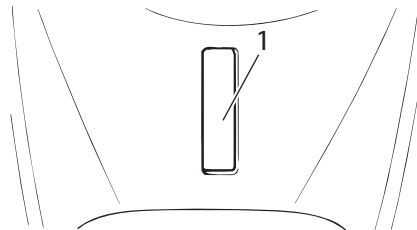

1. Vehicle identification number

The vehicle identification number is stamped into the frame.

NOTE: \_\_\_\_\_  
The vehicle identification number is used to identify your motorcycle and may be used to register your motorcycle with the licensing authority in your area.  
\_\_\_\_\_

# WARRANTY INFORMATION

Please read the instruction manual carefully prior use to familiarize yourself with the correct operation of your vehicle. Please keep in mind that the instructions concerning care, maintenance, and operation of your vehicle stated must be followed in order ensure your warranty remains valid. In addition to this the following instructions will ensure a satisfactory life span.

All supplied vehicles are provided with a two year limited warranty. This ensures that any faults caused by faulty manufacture, faulty materials or faulty design can be rectified.

Repairs can only be carried out at authorized workshops. Damage caused by inappropriate use, or incorrect maintenance cannot be claimed under warranty. Warranty repairs will only be approved if the fault is immediately reported to the selling dealer or another workshop authorized by KSR.

Warranty claim on entitles the customer to remedying a defect.

Warranty does not cover any consequential loss.

Neglected vehicles are excluded from warranty.

Please follow the following advice.

The vehicle must be cleaned regularly, using only mild automotive cleansers.

Never use high pressure washers, as these can remove decals, and damage bearings.

Never use aggressive cleansers or solvents as these can damage bodywork and cause corrosion to any metalwork.

It is vital to use protecting cleansers. Please consult our dealers for the right and appropriate products.

Any aluminium, anodised, or chrome bright work must be regularly treated with appropriate maintenance products in order to prevent oxidation.

Frame and metal parts are continuously to be treated with corrosion preventatives.

A vehicle constantly parked outside has to be covered to avoid weathering and splitting of plastic parts and seat covers.

Vehicles used off-road and for racing purposes are excluded from warranty.

Consumables such as cables, brake pads, spark plugs, chains, sprockets, drive belts, tires, are excluded from warranty.

# SERVICE PLAN

The warranty can be granted only if the vehicle has been serviced in accordance with this service plan.

**1000km or 1.month**

Stamp / Signature

**4000km or 6. month**

Stamp / Signature

**7000KM or 12. month**

Stamp / Signature

**10000km or 18. month**

Stamp / Signature

**13000KM or 24. month**

Stamp / Signature

**16000KM or 30. month**

Stamp / Signature

**19000KM**

Stamp / Signature

**21000KM**

Stamp / Signature

From 16000km maintenance should take place every 3000km or annually.

# WIRING DIAGRAM

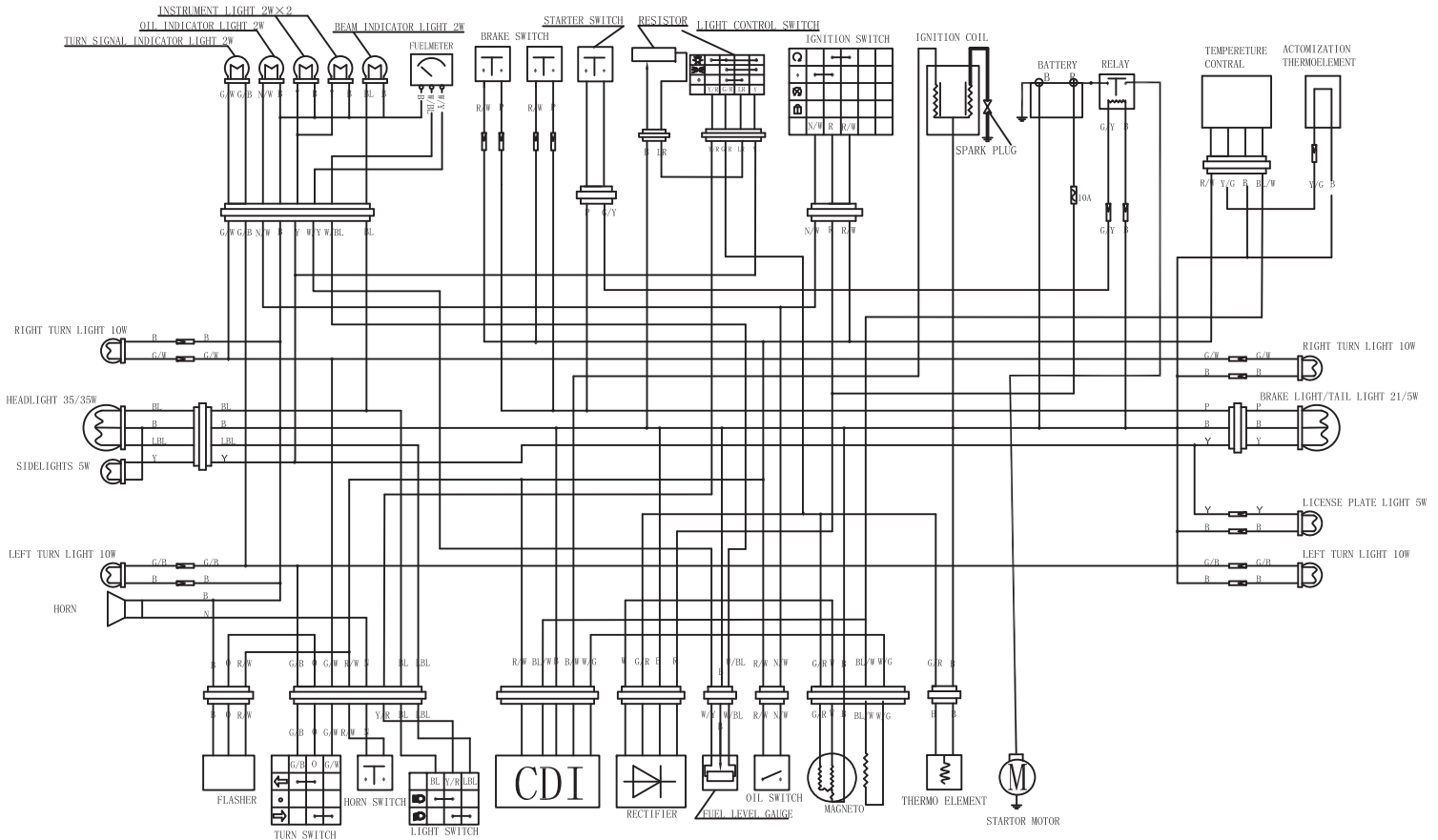

SYMBOL	B	R	W	BL	G	O	Y	P	N	LBL	Dg	G/Y	G/W	G/B	G/R	R/W	W/BL	B/W	N/W	Y/R	BL/W
COLOR	BLACK	RED	WHITE	BLUE	GREEN	ORANGE	YELLOW	PURPLE	BROWN	LIGHT BLUE	DARK GREEN	GREEN YELLOW	GREEN WHITE	GREEN BLACK	GREEN RED	RED WHITE	WHITE BLUE	BLACK WHITE	BROWN WHITE	YELLOW RED	BLUE WHITE





[www.genericeurope.com](http://www.genericeurope.com)