

BT50QT-9&BT49QT-3
SERVICE MANUAL

www.asiamotor.se Baotian European Spare parts Center

JIANGMEN SINO-HONGKONG BAOTIAN MOTORCYCLE INDUSTRIAL CO., LTD

CONTENTS

CHAPTER ONE MAINTENANCE OF THE MOTORCYCLE

I. ITEMS OF MAINTENANCE	1
II. PERIODIC MAINTENANCE SCHEDULE AND MAINTENANCE LOCATIONS	1
III. MAINTENANCE SPECIFICATIONS	4
IV. THROTTLE ACTUATION INSPECTION	5
V. AIR FILTER INSPECTION AND CLEANING	6
VI. REAR BRAKE FRICTION LINING INSPECTION	6
VII. BRAKE SYSTEM INSPECTION, ADJUSTMENT AND REPLACEMENT	7
VIII. FRONT AND REAR SHOCK ABSORBER INSPECTION	8
IX. FRONT WHEEL AND REAR WHEEL INSPECTION	9
X. STEERING STEM INSPECTION	10

CHAPTER TWO MAINTENANCE INFORMATION

I. FRAME NUMBER AND ENGINE NUMBER LOCATION	11
II. PRECAUTIONS IN OPERATION	11
III. SPECIFIED TORQUES	12

CHAPTER THREE BODY TROUBLESHOOTING

SECTION ONE BODY COMMON TROUBLES AND TROUBLE DETECTION	14
SECTION TWO DETAILED DESCRIPTIONS OF BODY PARTS TROUBLES	
I. FRONT WHEEL SERVICE	17
II. FRONT BRAKE SERVICE (DISK BRAKE)	19
III. FRONT SHOCK ABSORBER SERVICE	21
IV. FRONT FORK SERVICE	22
V. HANDLEBAR SERVICE	24
VI. REAR WHEEL SERVICE	25
VII. REAR BRAKE SERVICE	26
VIII. REAR SHOCK ABSORBER SERVICE	28

CHAPTER ONE MAINTENANCE OF THE MOTORCYCLE

I. ITEMS OF MAINTENANCE

When the motorcycle is used, loosening of parts and mechanical wear inevitably occur to varied extents. Neglect of timely maintenance not only reduces its mechanical function, economic performance, stability and durability, but also threatens the safety of the motorcycle and the rider. Correct and timely maintenance of the motorcycle is a must. Items of maintenance refer to the parts and positions for maintenance. Different items of maintenance are effected at different intervals and in different manners.

1. Running-in Maintenance

This is the maintenance at the end of the first 1000km and is an all-round inspection of the motorcycle. A newly-bought motorcycle or a motorcycle fresh from an overhaul might be severely overheated as a result of severe friction between the moving parts which might be imperfect in finishing or fitting. Neglect in use might lead to damage of the friction surfaces and might threaten the performance, and the service life, of the motorcycle. Please observe the following points:

- Restrict the speed in speed range specified in the instruction manual.
- Restrict the load to 2/3 of the maximum load and ride in fairly good road conditions.
- Restrict the length of riding time to avoid long-time running of the engine.
- Replace engine oil at short intervals so that metal chips caused in the running-in period can be discharged. It is recommended to replace engine oil for 3 times during the running-in period.

2. Routine Maintenance

Routine maintenance is the basis of all kinds of maintenances. It refers to the daily maintenance, including cleaning, inspection and common troubleshooting.

3. Periodic Maintenance

This maintenance is to restore normal performance of the motorcycle. The maintenance is classified into first-grade periodic technical maintenance and second-grade periodic technical maintenance (also known as items of maintenance) according to different mileages. Generally speaking, a first-grade maintenance is effected after the initial 4000km and a second-grade maintenance is effected every 8000km. As the service time extends, maintenance intervals should be shortened accordingly.

II. PERIODIC MAINTENANCE SCHEDULE AND MAINTENANCE LOCATIONS

After a period of use (one day, one month or half a year, for example) or a certain mileage (1000km, 4000km, 8000km, for example), an all-round maintenance operation should be effected, including comprehensive inspection, adjustment, tightening, lubrication, cleaning or replacement. The specific regulation made according to time intervals or mileages is known as maintenance interval. The motorcycle maintenance schedule is as follows.

1. Maintenance Schedule

Maintenance Schedule

time item	Mileage 1000km												
		1000	2000	3000	4000	5000	6000	7000	8000	9000	10000	11000	12000
Engine oil		New R 300km	R	R	R	R	R	R	R	R	R	R	R
Engine oil strainer					C				C				
Gasoline strainer											R		
Gear oil	Note 4	New R 300km				R					R		
Throttle play			A		A				A				A
Carburetor					I				I				C
Air filter	Note 3, 4	I				R					R		
Spark plug		Clean every 3000km, replace when necessary											
Brake system		I	I	I	I	I	I	I	I	I	I	I	I
Drive belt									I				
Suspension					I				I				I
Tire					I				I				I
Steering rod bearing		I						I					I
Screws and bolts of parts		I							I				
Rear brake cam							C						

Notes:

1. I: Inspect and when necessary, clean, lubricate, supplement, modify or replace;
A: adjust; C: clean; R: replace; T: tighten.
2. Effect periodic maintenance according to the instructions in the user's manual.
3. When the mileage exceeds the range specified in the schedule, repeat the maintenance.
4. In dusty or rainy conditions, inspection and replacement should be effected earlier.
5. In heavy load, long distance or rainy conditions, replacement should be effected earlier.

2. Maintenance locations



III. MAINTENANCE SPECIFICATIONS

The basic methods of motorcycle maintenance include inspection, adjustment, tightening, lubrication, cleaning, supplementing and replacement, which constitute the main elements of maintenance.

1. Inspection

Inspection refers to basic inspecting operations in accordance with items and requirements specified in the user's manual, including inspection with instruments or with eyes for abnormalities in machine parts, directly comparing related data and aligning with tools and gauges.

2. Adjustment

Adjustment refers to inspection-based adjustment and rectification of some specified machine parts, including adjustment of machine part plays and rectification of misfittings and deformations so as to restore correct positions, forms and plays.

3. Tightening

Tightening refers tightening of bolts, screws and nuts of machine parts with tools so as to avoid loosening of machine parts and to obtain specified tightening torques.

4. Cleaning

Cleaning is needed by machine parts and positions which call for cleanliness and tidiness. Cleaning operations include all the means and measures taken to remove dust, contamination, metal chips, oily stains and carbon deposits that might lead to pipe clogging or reduction in motorcycle performance. Cleaning measures are washing, carbon deposit removing, rubbing, cleaning and clearing.

5. Lubrication

In order to facilitate smooth and easy running of moving machine parts, including swinging parts, reciprocating parts, sliding parts and vibrating parts, to reduce scuffing, abrasion, deformation and to reduce friction, it is necessary to coat or spray these parts with a lubricant. Different lubricants and lubricating methods are required for different machine parts with different functions. Application of lubricants to machine parts is known as lubrication.

6. Replenishing, supplement and replacement

These operations refer to addition of oil, lubricants, cooling water, electrolyte, fuel and replacement of damaged parts with new ones and replacement of denatured oils with new oils.

IV. THROTTLE ACTUATION INSPECTION

Inspect throttle grip for easy and smooth movement.

Inspect throttle free travel.

Free travel: 2-6mm

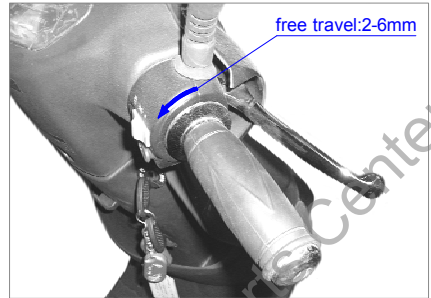

The main adjusting position is beside the carburetor.

Remove rear store case cover.

Adjust by loosening the fastening nut and turning the adjusting nut.

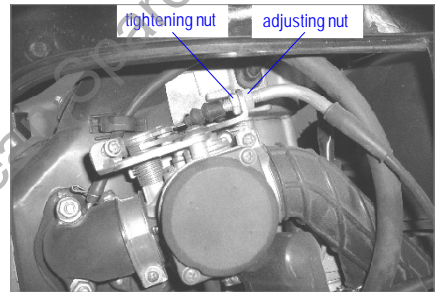

Fine adjustment is effected on the side of the throttle grip.

Effected adjustment is by removing the dust cover, loosening the tightening nut and turning the adjusting nut.

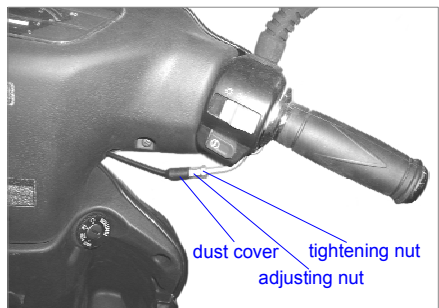

V. AIR FILTER INSPECTION AND CLEANING

After a certain mileage, dust and impurities will gather in air filter case and strainer, which will clog strainer pores and reduce inlet of air and thus lead to excessive concentration of mixed gas and reduce the performance of engine. That's why the strainer must be cleaned every 2000-3000km and in dusty or rainy conditions strainer must be cleaned or replaced earlier.

Remove 5 tightening bolts of air filter.

Remove strainer cover.

Take out the foam strainer.

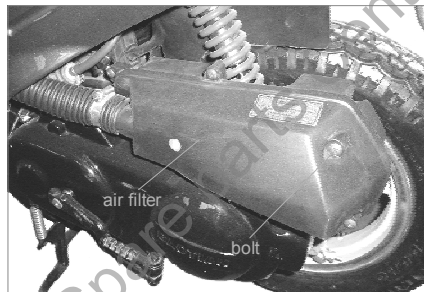

Immerse foam strainer in gasoline and wash it to remove dust and impurities by gripping and pressing.

Press gasoline out of the foam.

Soak the cleaned foam with engine oil, press out or throw out engine oil to leave it moist with oil.

Mount.

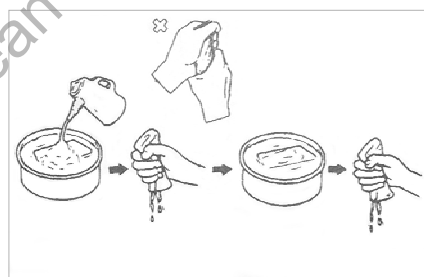

cleaning gripping gasoline soaking gripping

VI. REAR BRAKE FRICTION LINING INSPECTION

If the arrow on brake swing arm is aligned with the scotch on gear case when brake lever is drawn to the stopping position, friction linings must be replaced with new ones.

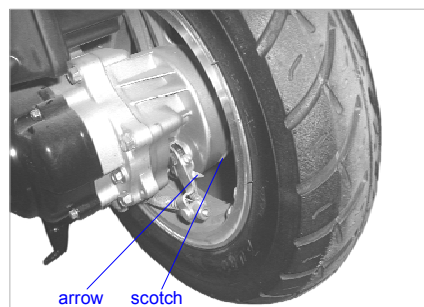

VII. BRAKE SYSTEM INSPECTION, ADJUSTMENT AND REPLACEMENT

1. Front brake (disk brake)

Remove the bolts linking brake caliper and front shock absorber;

Remove brake caliper.

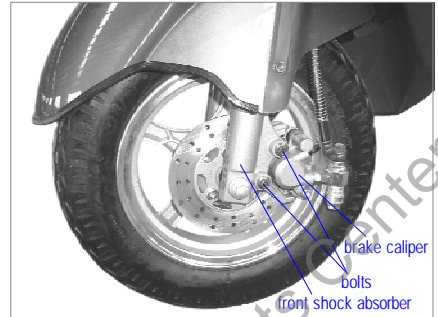

* Do not pull brake lever when brake caliper is removed so as to prevent jamming of brake block.

If brake block is jammed, pry it with screwdriver and push piston back into caliper.

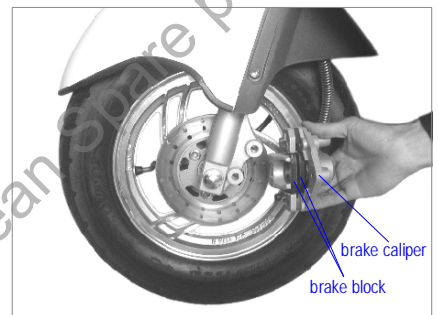

Brake Block Replacement:

Brake block must be replaced when it is worn to the limit of use.

* It is not necessary to remove brake oil pipe when replacing brake block.

* Brake block must be replaced as a set.

Remove the brake block pin by means of a hexagon wrench.

Return brake caliper left part counter-clockwise, remove old brake block and mount new brake block.

Effect mounting in an order reversed to that of dismantling.

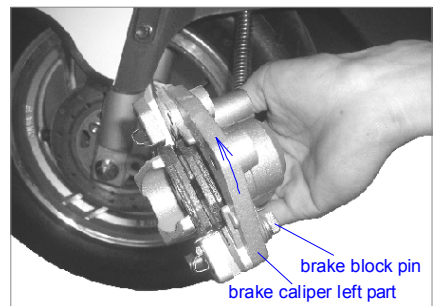

Brake Disc Inspection:

Inspect brake disc thickness.

Limit of use: 3.0mm

Inspect brake disc angularity.

Limit of use: 0.3mm

2. Rear Brake

Inspect rear brake lever free travel.

Free travel: 10-20mm

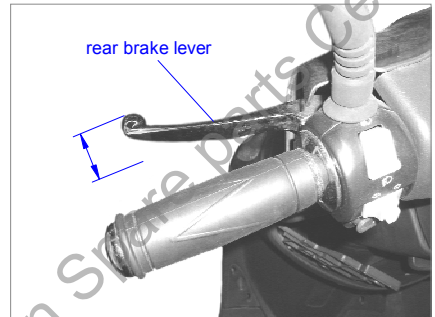

Turn adjusting nut to effect adjustment when free travel exceeds limit.

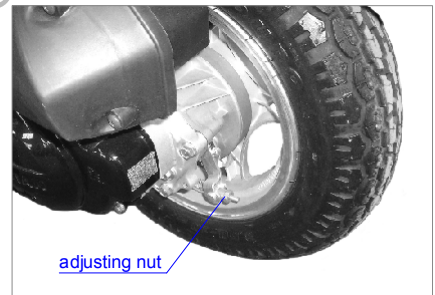

VIII. FRONT AND REAR SHOCK ABSORBER INSPECTION

1. Front Shock Absorber

Tighten front brake lever, press front shock absorber up and down and inspect actuation.

Inspect front shock absorber to see if there is leakage of oil and if there is damage or loosening.

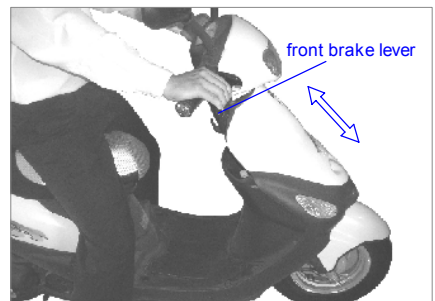

2. Rear Shock Absorber

Press rear shock absorber to inspect actuation. Inspect rear shock absorber to see if there is oil leakage and if there is damage or loosening in machine parts.

Lift rear wheel, press rear wheel right and left to inspect if engine suspension lug buffer bush is loose.

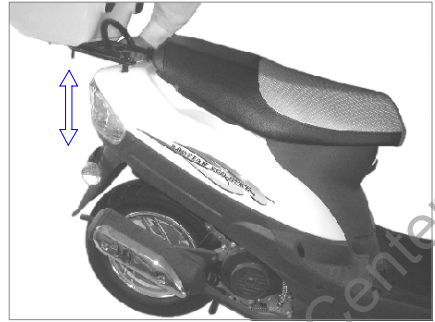

IX. FRONT WHEEL AND REAR WHEEL INSPECTION

Wheel Rim Inspection:

Inspect wheel rim, remove rust stains and rubber chips.

Deformation and fissures are causes of air leakage. Do not use wheel rims in the following cases:

Bruise of wheel rim face contacting tire bead ring exceeds 0.5mm in depth and 1.0mm in width.

Tire Inspection:

Inspect if there is fissure or iron nail in the tire.

In one of the following conditions, tires must be replaced instead of repair.

- Puncture of tire by a foreigner matter 6mm in diameter or tire fissure.
- Layered tire.
- Chunking of tread
- Damaged tire bead
- Broken tire bead or other tire bead damages
- Broken tire cord
- Damage due to forced dismounting
- Fissure extending to frame
- Abnormal inner lining
- Tire groove wear: front wheel < 0.8mm, rear wheel < 0.8mm.
- Punctured or otherwise damaged tire flank

Inspect tire pressure by means of a tire pressure gauge

* Tire pressure should be inspected when the motorcycle is in a cold state.

Specified pressure	Unit: kPa
Front wheel	200
Rear wheel	225

Tire Specifications:

Front wheel 3.0-10/3.50-10

Rear wheel 3.0-10/3.50-10

Inspect if front wheel nut is loose.

Inspect if rear wheel nut is loose.

If loose, tighten them to specified torques.

Torques: front wheel nut 60N·m

rear wheel nut 120N·m

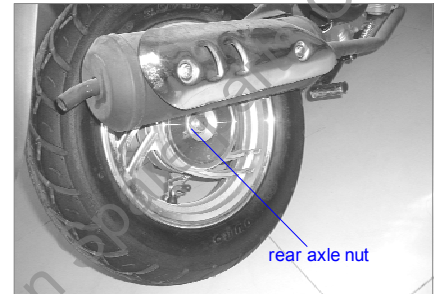
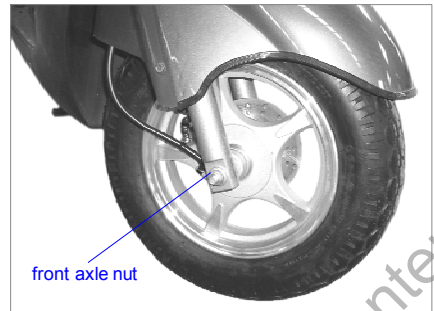

X. STEERING STEM INSPECTION

Swing handlebar right and left to see if there is interference such as wire or other things.

Turn front wheel to see that handlebar is easy in operation.

In case of any difficulty in operation, inspect steering stem bearing assembly.

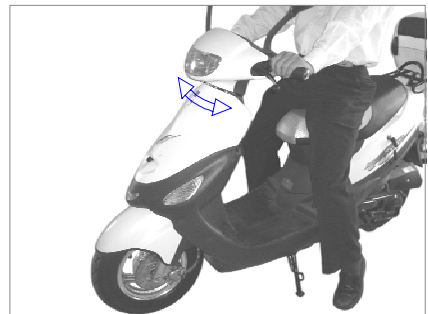

CHAPTER TWO MAINTENANCE INFORMATION

I. FRAME NUMBER AND ENGINE NUMBER LOCATION

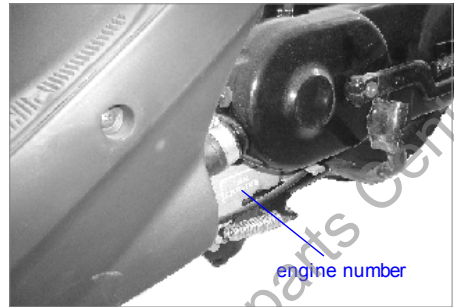
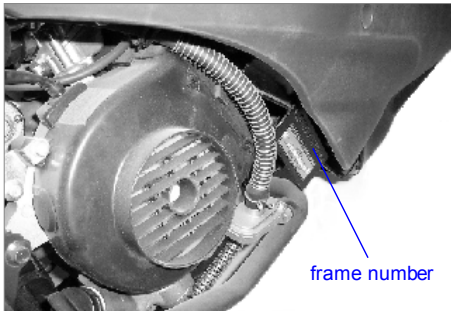

II. PRECAUTIONS IN OPERATION

- Removed washers, 0-rings, elastic retaining rings and split pins must be replaced with new ones.
- When mounting bolts, nuts and screws, proceed from trial tightening, from larger diameters to smaller diameters and inner ones to outer ones in a diagonally order. Tighten them to specific torques.
- Parts and greases must be those made by our factory or recommended by our factory.
- Special operations must be effected with special tools or specified universal tools.
- Removed parts must be rubbed or cleaned before they are inspected or measured. They must be coated on the sliding faces before mounting.
- They must be greased at the specified positions with designated or equivalent greases.
- Parts must be tightened and their performances inspected at their positions when mounted.
- The battery's negative terminal must be disconnected before operation.
Make sure that tools such as wrenches are not in contact with the frame.
- At the completion of operations, reconfirm correct connections and fastenings.
The positive terminal must be connected first in case of a removed battery.
Connected terminals must be coated with lubricant.
The terminals must be completely covered with caps.
- When a fuse is burnt, inspect the cause and replace the fuse with a fuse of equivalent capacity.
- At the completion of operation, completely cover terminals with caps.
- When removing connectors with locks, they must be unlocked before operation.
When removing connectors, the connectors proper must be held instead of pulling their wires.

- Before connecting connectors, confirm that they are free from breakage, bending, over length or loosening.
- Connectors must be inserted home.
When connecting connectors with locks, confirm that their locks are fastened.
Confirm that the wires are not loose.
- Confirm that connectors' plastic sleeves completely cover the connectors without fail.
- Before connecting the connectors, confirm that their sleeves are free from breakage and their terminals are not oversized.
- Connector plugs must be fully inserted.
Confirm that plastic sleeves completely cover the terminals.
Plastic sleeves should not be placed with the open side up.
- Wire bunch bands should be fixed at the specified position of motorcycle frame.
- Wire clamps must correctly keep wires in place.
Avoid welding stains of welded clamps when clamping wires.
- Wire bunches must be fixed away from turning or moving parts.
- Do not damage the covering of wire bunches.
In case of wire bunch defects, remedy it with insulating bands.
- Wire bunches must not be covered with mounted parts.
- Do not twist or bend cables by force. Deformed or damaged cables would result in poor rotation or damage.

III. SPECIFIED TORQUES

Torques at important positions and standard torques of other positions are as follows:

SPECIFIED TORQUES

Frame:

Designations of tightening positions	Number	Thread specification	Torques: N· m
Engine suspension lug mounting nut	1	M10	45
Engine mounting nut	1	M10	45
Front axle nut	1	M12	60
Rear axle nut	1	M16	120
Rear shock absorber upper mounting bolt	1	M10	40
Rear shock absorber lower mounting bolt	1	M10	25
Front shock absorber upper lock bolt	4	M8	35
Steering stem lock nut	1	M25	70
Handlebar mounting nut	1	M10	45
Upper bearing top	1	M25	2.5
Exhaust muffler connector nut	2	M6	12
Exhaust muffler mounting bolt	2	M8	35

Standard Torques:

Designations	Torques: N· m
Bolt, nut M5	5
Bolt, nut M6	10
Bolt, nut M8	21.5
Bolt, nut M10	35
Bolt, nut M12	55
Screw M5	4
Screw M6	9
Flange bolt, nut M6	12
Flange bolt, nut M8	27
Flange bolt, nut M10	40

CHAPTER THREE BODY TROUBLESHOOTING

SECTION ONE BODY COMMON TROUBLES AND TROUBLE DETECTION

Body part common troubles and possible causes are as follows:

Troubles	Causes	Details (reference)	
Handlebar rotation not easy (strenuous turning or unstable tightness)	Over tightening of handlebar adjusting nut	Refer to “Front Fork Service”	
	Steering stem over worn		
Heavy steering stem turning	Incorrect mounting of brake cable or tachometer cable	Refer to “Handlebar Service”, “Front Fork Service”	
	Remarkable deformation of steering stem due to outside impact	Refer to “Front Fork Service”	
	Over tightening of steering stem top ball bearing retainer		
	Damaged or broken ball bearing		
Reduced tire air	Refer to “Front Wheel Service”, “Rear Wheel Service”		
Deflected steering stem	Imbalance of right and left shock absorbers	Refer to “Front Shock Absorber Service”	
	Bent front fork	Refer to “Front Fork Service”	
	Bent front tire, deflected tire	Refer to “Front Wheel Service”	
Drum brake failure	Normal wear of brake lining	Refer to “Brake System Inspection, Adjustment and Replacement”, “Rear Brake Service”	
	Hardened brake block or dusty block		
	Excessive front brake and rear brake		
	Damaged brake cable		
	Brake cam rotation not easy		
	Worn brake block		
Worn or slotted brake drum bore			
Disk brake failure	Feeble brake lever	Bent brake lever	Refer to “Brake System Inspection, Adjustment and Replacement”, “Front Brake Service”
		Air in hydraulic device	
		Leakage in hydraulic device	
		Clogged hydraulic passage	

Chart continued

Troubles	Causes		Details (reference)
Disk brake failure	Feeble brake lever	Inadequate liquid	Refer to “Brake System Inspection, Adjustment and Replacement”, “Front Brake Service”
		Contaminated brake block and brake disc	
		Bent or deformed brake disc	
		Contaminated brake caliper	
		Worn seal ring of brake caliper piston	
		Viscous or worn brake caliper piston	
		Inability of brake caliper normal sliding	
		Worn main cylinder piston seal ring	
		Viscous or worn main cylinder piston	
		Contaminated main cylinder	
		Stiff brake lever	
	Clogged narrow liquid passage		
	Viscous worn brake caliper		
	Inability of brake caliper normal sliding		
	Worn seal ring of brake caliper piston		
	Viscous or worn main cylinder piston		
	Resisted braking	Contaminated brake block and brake disc	
		Bent or deformed brake disc	
		Inability of brake caliper normal sliding	
Wheel not adjusted straight			

Chart continued

Troubles	Causes	Details (reference)
Abnormal braking sound	Hardened brake block surface or dusty block	Refer to "Rear Brake Service"
	Uneven or slotted brake block surface	
	Serious wear of brake block lining	
	Serious slots inside brake drum	
Deviation of motorcycle direction (inclining to roadside)	Steering stem rotation not easy	Refer to "Front Fork Service"
	Bent shock absorber	Refer to "Front Shock Absorber Service"
	Shock absorber oil leakage	
	Bent front axle, incorrect wheel mounting	Refer to "Front Wheel Service"
	Roundness error of wheel rim	
	Deformation of wheel rim	
	Inadequate tire pressure	
Front wheel oscillation	Deformed wheel rim	Refer to "Front Wheel Service"
	Loose front wheel bearing	
	Poor tire	
	Poor axle locking	
Soft front shock absorber	Spring fatigue	Refer to "Front Shock Absorber Service"
Rear wheel oscillation	Deformed wheel rim	Refer to "Rear Wheel Service"
	Poor wheel	
Soft rear shock absorber	Spring fatigue	Refer to "Rear Shock Absorber Service"

SECTION TWO DETAILED DESCRIPTION OF BODY PARTS TROUBLES

Precautions in Operation:

- Forced mounting or dismounting of body cover parts will cause damage to claws and slots of corresponding hoods.
- When mounting body cover parts, be sure to align the corresponding parts of hoods.
- When mounting body cover parts, avoid pressing wires, cables or pipes.

-

I. FRONT WHEEL SERVICE

Front Wheel Dismounting:

Support the body bottom to lift front wheel.

Remove front axle nut, brake calipers, front absorbers connecting bolt and remove brake calipers, front shock absorber, transmission gear box, front axle bush and the small bush, remove front axle.

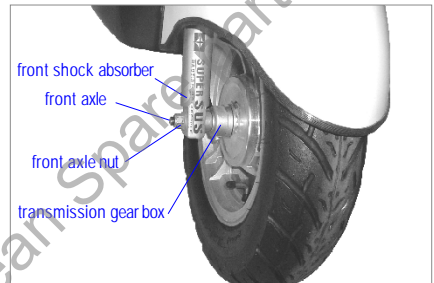

Remove front wheel.

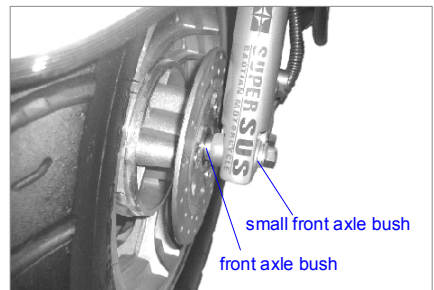

Remove brake disc mounting bolts.

Remove brake disc.

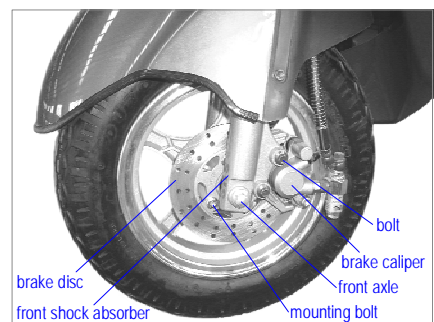

Axle Bending Inspection

Place axle on a V-seat and measure with a dial gauge.

The dial gauge indicates a 1/2 bending value.

Limit of use: Replace if $>0.2\text{mm}$.

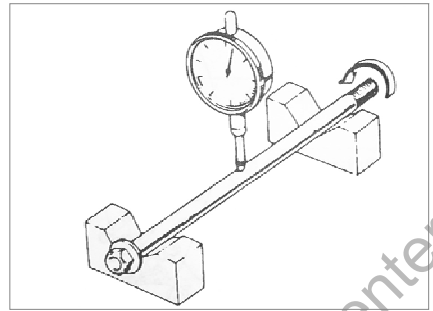

Wheel Rim Oscillation Inspection

Measure oscillation value on a correcting bench.

Limit of use: Replace if $>2.0\text{mm}$.

Traverse direction: Replace if $>2.0\text{mm}$.

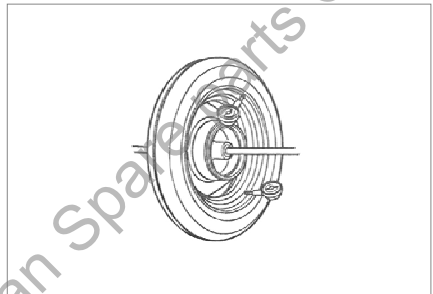

Front Wheel Bearing Inspection

Remove front wheel bearing and dust cover.

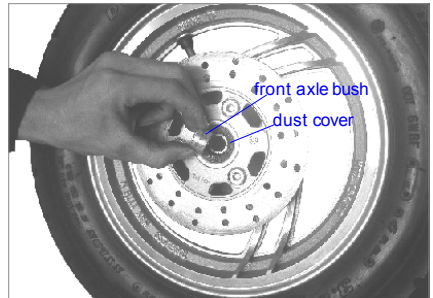

Turn bearing inner race to inspect sliding.

Replace it with a new one in case of no sliding or damage or loosening of outer race.

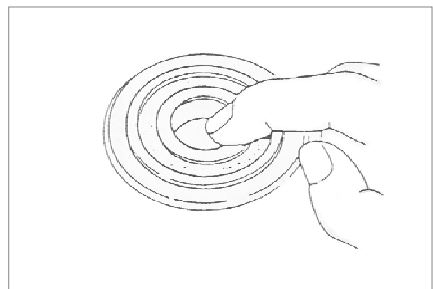

Front Wheel Bearing Replacement

Dismounting: Remove front wheel bearing by means of a bearing remover, take out spacer.

Mounting: Apply grease to the bearing.

Drive in left bearings.

Mount spacer.

Drive in right bearings.

- Bearings must be driven in parallel.
- Dust cover must be driven in with the face out.

Apply grease to new dust cover lip.

Mount front axle bush.

Front Wheel Mounting

Mount brake disc, tighten brake disc mounting bolts.

Torque: 27N·m

Spread front axle with a thin film of grease.

Mount front axle from left side.

Mount in order small bush, left front shock absorber, bush, front wheel, transmission gear box, right front shock absorber, front axle nut and fasten it.

Torque: 60N·m

Mount brake caliper as specified.

II. FRONT BRAKE SERVICE (DISK BRAKE)

Brake Oil Replacing

- Prevent dust or water from entering brake system.
- Do not use brake oils of different specifications or impure brake oils.
- Prevent brake oil from dripping onto rubber, plastic or painted parts.

Brake Oil Exhausting

Place main cylinder at a level place, remove oil reservoir cover and diaphragm.

Connect a hose to oil exhaust valve, loosen exhaust valve, grip and release brake lever till oil is exhausted.

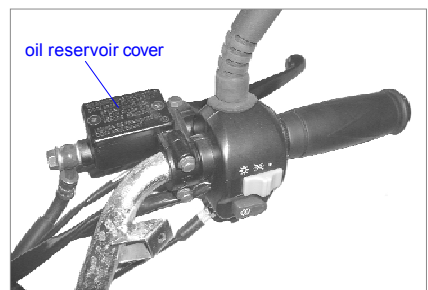

Brake Oil Replenishing

Lock exhaust valve.

Replenish oil reservoir with specified brake oil.

- It is not necessary to fill the oil reservoir to its full capacity.
- Brake oil for replenishing should be the same as original.

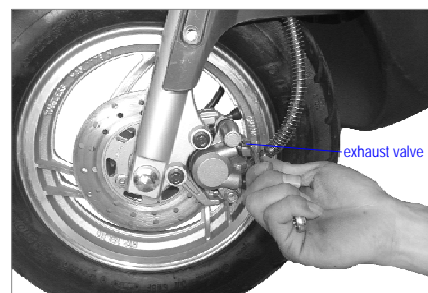

The specification of brake oil is indicated on the reservoir cover.

Place diaphragm.

Connect a transparent hose to exhaust valve.

Grip brake lever fast and open exhaust valve 1/2 turn to let out air and lock exhaust valve. Repeat this operation till no bubbles are exhausted from brake oil passage.

- Do not release brake lever before exhaust valve is closed.

At the completion of adjustment, replenish brake oil till oil is over the lower limit line of the oil reservoir.

Mount diaphragm set and oil reservoir cover.

Tighten oil reservoir cover bolt.

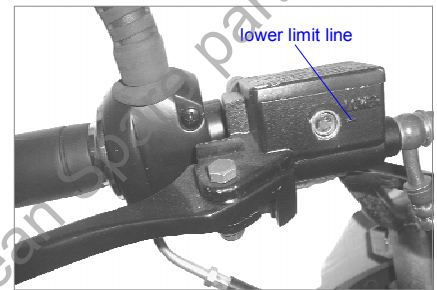
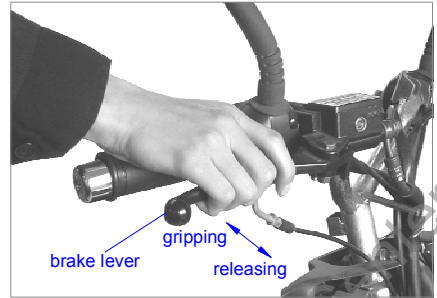

Main Brake Oil Tank Dismounting and Mounting

Dismounting

Remove 4 screws of front part and rear part of head cover.

Remove front part and rear part of head cover.



Exhaust brake oil from front brake system.

Pull out brake switch plug from main cable.

Remove bracket bolts from handlebar;

Remove main cylinder.

Remove brake oil pipe from main cylinder.

- Prevent brake oil from splashing to rubber, plastic or painted surfaces. Cover the above-mentioned parts with a cloth.

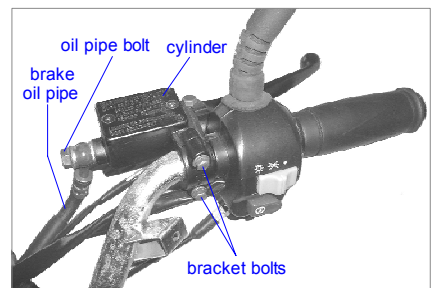

Remove brake light switch and brake lever.

Remove retaining ring from main cylinder.

- Use special retaining ring remover when removing retaining ring.
Remove piston cover, piston and spring.
Clean oil reservoir and piston with pure brake oil.
- Do not effect cleaning with gasoline as it is corrosive to rubber parts.

Inspection

Inspect for wear or ageing of main and auxiliary cups on pistons.

Inspect for scratches and other damages on main cylinder and piston.

Measure main cylinder bore.

Measure outside diameter of piston at the end of auxiliary cup.

Mounting

Apply pure brake oil to piston, main cup and auxiliary cup.

Mount spring, piston, retaining ring and piston cap.

- Piston cup cannot be used inside out.

Apply grease to brake lever axis pin.

Mount brake lever and brake switch.

Mount main cylinder, main cylinder bracket and lock them.

Mount brake oil pipe.

Connect brake light switch cable with switch.

Mount head cover front part and rear part.

Replenish brake oil and exhaust air in brake system.

III. FRONT SHOCK ABSORBER SERVICE

Dismounting

Remove fender mounting bolt and front fender.

Remove front wheel.

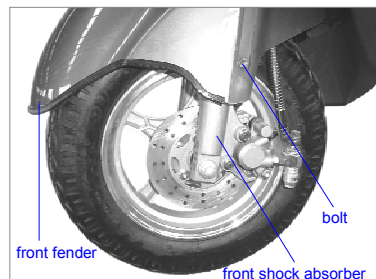

Remove 4 pieces of bolts on the upper part of front shock absorber.

Remove shock absorber.

Inspection

Inspect if there is oil leakage in front shock absorber, if there is deformation of shock absorber arm and if there is damage or loosening of any part.

Mounting

Mount front shock absorber on front fork and mount 4 bolts.

Torque: upper bolt 35N·m.

Mount front wheel.

Mount front fender.

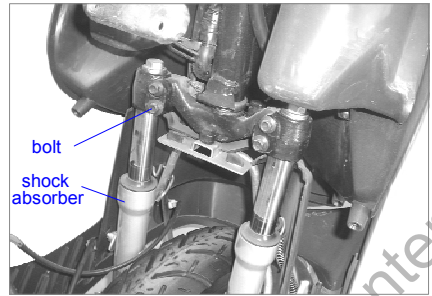

IV. FRONT FORK SERVICE

Dismounting

Remove motorcycle body covering parts.

Remove handlebar bolt, bush and nut from handlebar.

Remove handlebar.

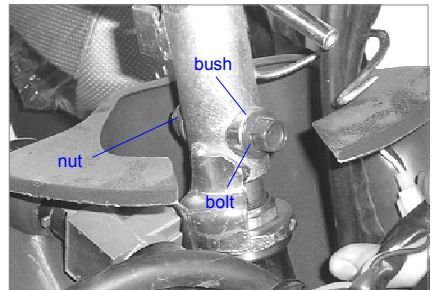

Remove steering stem setting nut.

Remove upper bearing cup, upper bearing top and bearing set.

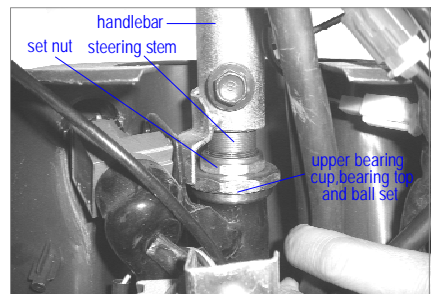

Remove front wheel;

Remove front shock absorber, front fender bracket, etc.

Remove steering stem from head tube.

The removing of the bottom bearing cup, bearing top and bearing set is the same as the removing of the upper series.

- Do not damage steering stem when removing bearing cup and bearing top.
- Clean opening parts of motorcycle body covering parts with cloth.

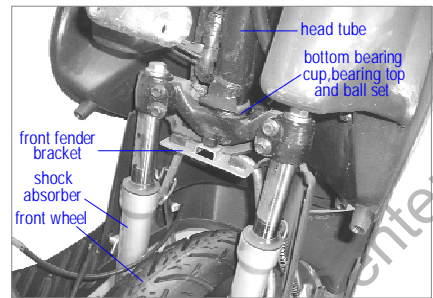

Inspection

Inspect if there is slot or pit in bearing cup and bearing top. If there is, effect replacement.

Inspect for completeness of bearing balls and if there is, effect replacement with new ones.

Inspect for proper tightness of steering stem and if not, effect adjustment and fasten it.

Inspect for correct position of bearing cup and bearing top and if not, effect correct mounting.



Bearing Cup and Bearing Top Replacement

Remove bearing cup and bearing top with special bearing cup and bearing top removers.

Mounting

Apply grease to bearing cup and bearing top at the bottom.

Mount in order bottom bearing cup, bearing ball set, bottom bearing top on the bottom of steering stem.

Pass steering stem through head tube.

Mount front fender bracket.

Mount front wheel.

Mount front shock absorber and other parts.

Apply grease to top bearing cup and bearing top.

Mount in order upper bearing cup, bearing ball set and upper bearing top on the upper part of steering stem and fasten them.

Torque: 15 N·m

Turn front fork right and left to effect close contact of bearing balls.

Loosen upper bearing top to torque 0 and fasten it.

Torque: 2.5N·m

Fix upper bearing top and tighten steering stem setting nut.

Torque: 70N·m

Turn front fork and confirm easy rotation without loosening.

Mount handlebar bolt, bush and nut from handlebar.

Mount handlebar.

Mount front fender.

Mount motorcycle body covering parts.

V. HANDLEBAR SERVICE

Dismounting

Remove covering parts of front part and rear part.

Remove connectors of left handlebar switch.

Remove 2 screws of left handlebar switch.

Remove left handlebar switch.

Remove left grip from handlebar.

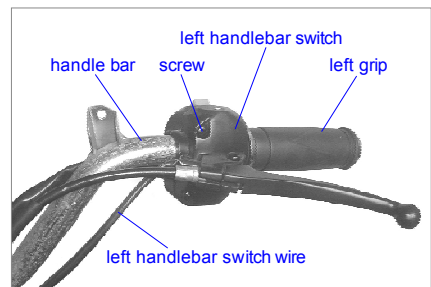

Remove front brake main cylinder.

Remove connectors of right handlebar switch.

Remove 2 screws of right handlebar switch.

Remove right handlebar switch.

Remove throttle cable from throttle grip.

Remove throttle grip from handlebar.

Remove handlebar bolt, bush and nut from handlebar.

Remove handlebar.

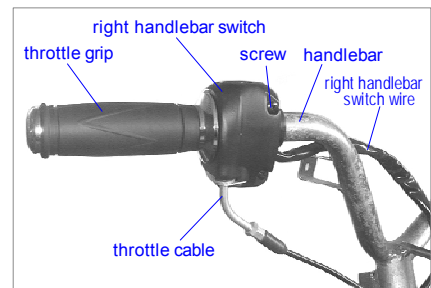

- When removing left handlebar and throttle grip, remove contamination and grease from contacting face.

Mounting

Mount handlebar on steering stem guide tube, fit bush, setting bolt and nut.

Torque: 45 N·m

Mount left handlebar switch and fasten screws.

Torque: 9 N·m

Mount front brake main cylinder and fasten bolts.

Mount right handlebar switch and fasten screws.

Torque: 9 N·m

Apply grease to throttle cable.

Mount throttle grip and connect throttle cable.

Mount left grip.

Mount covering parts of front head cover and rear head cover.

- Confirm easy rotation of throttle grip.
- When mounting handlebar rubber, apply a thin film of adhesive to contacting face and then mount grip in a turning manner.

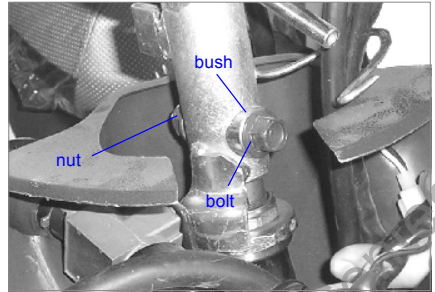

VI. REAR WHEEL SERVICE

Dismounting

Remove 2 connecting nuts and 2 mounting bolts of exhaust muffler.

Remove exhaust muffler.

Remove rear axle nut and rear axle.

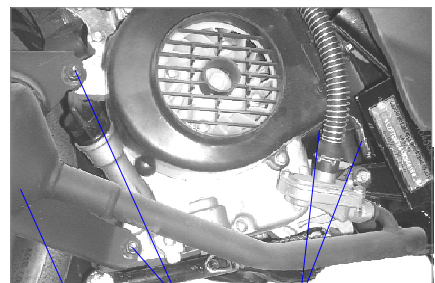

Rear Wheel Oscillation Inspection

Measure oscillation value on a correcting bench.

Limit of use: Longitudinal >2.0 mm

Traverse >2.0 mm

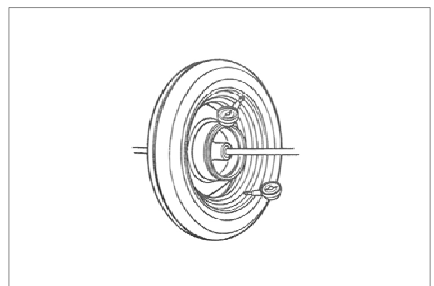

Mounting

Mount rear wheel and fasten rear axle nut.

Torque: 120N·m

Mount exhaust muffler.

Fasten exhaust muffler connecting nuts and bolts.

Torque:

Exhaust muffler connecting nut: 12N·m

Exhaust muffler mounting bolt: 35N·m

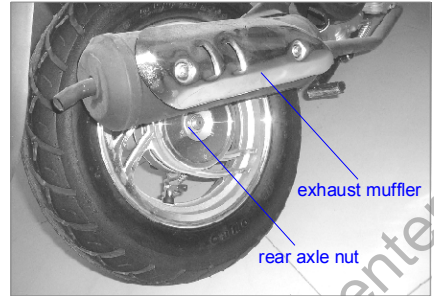

VII. REAR BRAKE SERVICE

Remove exhaust muffler.

Remove rear wheel.

Inspect rear brake drum.

Measure rear brake drum bore.

Limit of use: $\varnothing 111\text{mm}$, effect replacement if the limit is exceeded.

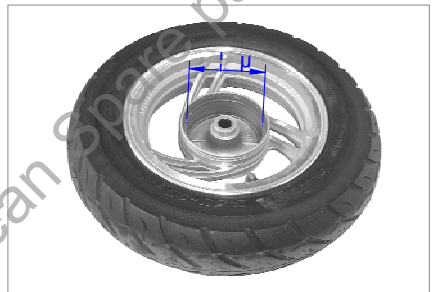

Rear Brake Block Replacement

Remove rear brake block and return spring as a whole and replace them with new ones.

- See that no grease is with brake block friction surface.

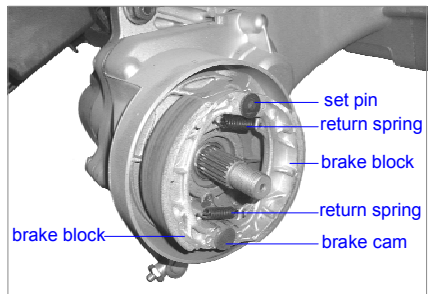

Rear Brake Disassembling

Remove rear brake adjusting nut, remove rear brake cable from brake swing arm.

Remove brake block assembly.

Remove brake swing arm setting bolt and swing arm.

Remove brake cam.

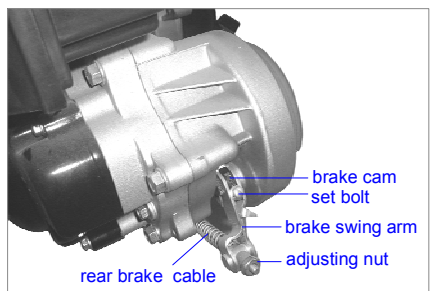

Rear Brake Device Assembling

Apply grease to setting pin, brake cam and brake block friction surface.

Apply grease to moving part of brake cam.

- Do not apply grease to parts not specified. Superfluous grease flows into brake friction linings of brake drum shall reduce braking effect.

Mount brake cam.

Mount brake swing arm on brake cam.

- Notch on brake swing arm should be aligned with the cut-off of brake cam.

Mount brake swing arm setting bolt and fasten it.

Torque: 10N·m

Mount brake block assembled with spring.

Mount rear wheel.

Mount exhaust muffler.

Mount brake swing arm pin and rear brake cable.

- Mount return spring of brake cable with the spring aligned with the recess hole of left crankcase cover.

Mount adjusting nut.

Adjust brake system.

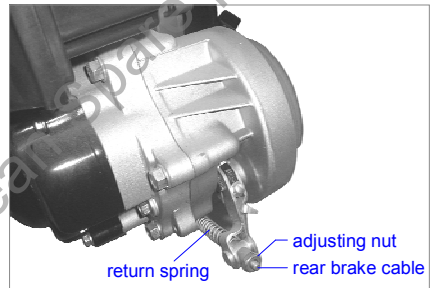

VIII. REAR SHOCK ABSORBER SERVICE

Dismounting

Remove motorcycle body covering parts.

Remove 2 mounting bolts of air filter.

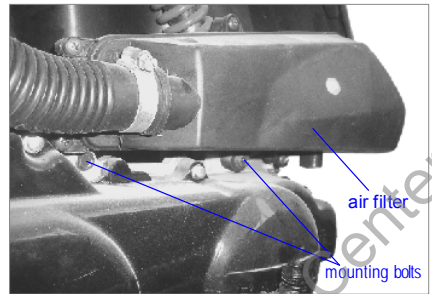

Remove mounting bolt connecting rear shock absorber and motorcycle frame, bolt connecting rear shock absorber and engine.

Withdraw air filter;

Remove rear shock absorber.

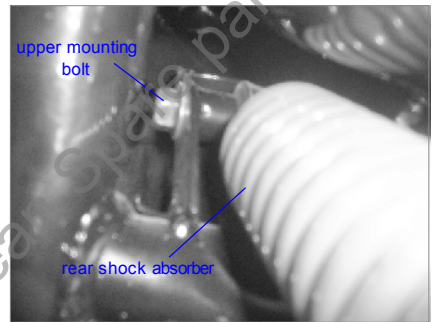

Inspection

Inspect rear shock absorber oil seal for oil leakage, inspect buffer bar and spring for deformation and other parts for damage and loosening.

Mounting

Mount rear shock absorber.

Torque:

upper mounting bolt: 40N·m

bottom mounting bolt: 25N·m

Mount air filter.

Mount motorcycle body covering parts.

